

This catalog contains part numbers for the most common replacement parts for QMARK heaters shown in the Table of Contents. Additional parts for these heaters may be available - consult factory for availability. Parts for QMARK heaters not listed in the Table of Contents may be available - consult factory for availability.

**NOTE:** Parts longer than 8' in length cannot ship UPS. Consult factory for shipping information.

## TABLE OF CONTENTS

<b>BASEBOARD</b>	<b>UNIT HEATERS</b>	<b>RADIANT</b>
2500 & QMKC ..... 2	CU900 ..... 19	BRM ..... 38
Baseboard Accessories ..... 4	CHPR25 ..... 21	FRP & FRS ..... 39
HBB ..... 5	IUH ..... 22	HRK ..... 40
<b>WALL HEATERS</b>	MEDH MODEL D ..... 23	RCC ..... 41
SSAR ..... 6	MSDH ..... 24	<b>PORTABLE</b>
SSHO ..... 7	PRH ..... 25	QPH4A ..... 29
HT ..... 8	MUJ ..... 26	FBE ..... 42
AWH & WHFC ..... 9	MWUH ..... 28	LFP ..... 42
CWH3000 ..... 10	MUH35 ..... 29	FHP ..... 43
CWH1000 ..... 11	QWD ..... 30	<b>INDUSTRIAL PRODUCTS</b>
CWH ARCHITECTURAL SERIES ..... 12	<b>CONVECTORS</b>	DOE CEILING FANS ..... 44
LFK ..... 13	KCJ ..... 31	
GFR ..... 14	DBA ..... 32	
SED ..... 15	SHA ..... 32	
COS-E ..... 16	SLQDB ..... 33	
<b>SPECIALTY HEATERS</b>	DBSL ..... 34	
QTS ..... 17	ST ..... 35	
FDI ..... 17	CSH ..... 36	
WHT ..... 17	DSH ..... 36	
<b>CEILING HEATERS</b>	CPH ..... 36	
QCH ..... 18	DPH ..... 36	
EFF ..... 18	THX ..... 37	
CDF ..... 18		

## OBSOLETE PRODUCTS

SOME PARTS MAY NO LONGER BE AVAILABLE FOR OBSOLETE PRODUCTS

<b>WALL HEATERS</b>	<b>CONVECTORS</b>	<b>INDUSTRIAL PRODUCTS</b>
MCSSAR ..... 45	KD/KS ..... 59	COMMERCIAL CEILING FANS ..... 65
QFG ..... 46	QDB ..... 59	
EFQ ..... 47	APH ..... 60	
ECP ..... 48	ADB ..... 60	
AFA ..... 49	ASH ..... 60	
CRA ..... 50	<b>RADIANT</b>	
QVP ..... 51	ARL ..... 61	
A2500 ..... 51	CRN ..... 62	
1235 & 2435 ..... 52	FFR ..... 63	
B2400 ..... 52	CHRR ..... 63	
CWH2000 ..... 53	RDO ..... 64	
<b>PORTABLE</b>	QRH ..... 64	
WPC ..... 54	<b>SPECIALTY HEATERS</b>	
<b>UNIT HEATERS</b>	CFWF ..... 17	
TBX ..... 55	<b>BASEBOARD</b>	
CU-A ..... 56	CBD ..... 5	
CU-B ..... 56		
VUH ..... 57		
VUH-A ..... 57		
MEDH ..... 58		

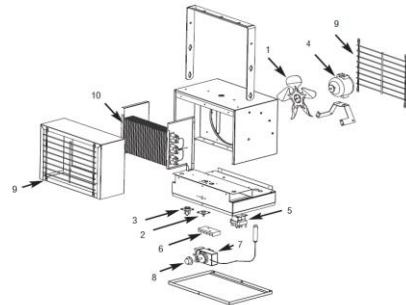

FOR SERVICE PARTS CONTACT CARROLL PARTS 800-654-3545

C2500 & 2500 SERIES

ELEMENTS

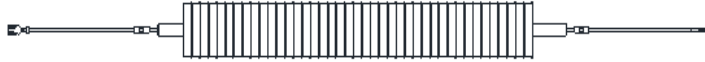

<p><b>1802-11021-008</b></p> <p>2573WCA 2573NWCA C2573WCA C2573NWCA</p>	<p><b>1802-11021-009</b></p> <p>2543WCA 2543NWCA C2543WCA C2543NWCA</p>	<p><b>1802-11021-010</b></p> <p>2503WCA 2503NWCA C2503WCA C2503NWCA</p>	<p><b>1802-11021-011</b></p> <p>2513WCA 2513NWCA C2513WCA C2513NWCA</p>	<p><b>1802-2044-014</b></p> <p>2574WCA 2574NWCA C2574WCA C2574NWCA</p>	<p><b>1802-2044-015</b></p> <p>2544WCA 2544NWCA C2544WCA C2544NWCA</p>
<p><b>1802-2044-026</b></p> <p>2576WCA 2576NWCA C2576WCA C2576NWCA</p>	<p><b>1802-2094-017</b></p> <p>2546WCSA 2546NWCSA C2546WCSA C2546NWCSA</p>	<p><b>1802-2044-028</b></p> <p>2506WCA 2506NWCA C2506WCA C2506NWCA</p>	<p><b>1802-2094-015</b></p> <p>2516WCSA 2516NWCSA C2516WCSA C2516NWCSA</p>	<p><b>1802-2044-016</b></p> <p>2504WCA 2504NWCA C2504WCA C2504NWCA</p>	<p><b>1802-2044-017</b></p> <p>2514WCA 2514NWCA C2514WCA C2514NWCA</p>
<p><b>1802-2044-020</b></p> <p>2575WCA 2575NWCA C2575WCA C2575NWCA</p>	<p><b>1802-2044-021</b></p> <p>2545WCA 2545NWCA C2545WCA C2545NWCA</p>	<p><b>1802-2044-022</b></p> <p>2505WCA 2505NWCA C2505WCA C2505NWCA</p>	<p><b>1802-2044-023</b></p> <p>2515WCA 2515NWCA C2515WCA C2515NWCA</p>	<p><b>1802-2094-000</b></p> <p>2508WCSA 2508NWCSA C2508WCSA C2508NWCSA</p>	<p><b>1802-2094-001</b></p> <p>2548WCSA 2548NWCSA C2548WCSA C2548NWCSA</p>
<p><b>1802-11021-000</b></p> <p>2572WCA 2572NWCA C2572WCA C2572NWCA</p>	<p><b>1802-11021-001</b></p> <p>2542WCA 2542NWCA C2542WCA C2542NWCA</p>	<p><b>1802-11021-002</b></p> <p>2502WCA 2502NWCA C2502WCA C2502NWCA</p>	<p><b>1802-11021-003</b></p> <p>2512WCA 2512NWCA C2512WCA C2512NWCA</p>	<p><b>1802-2094-002</b></p> <p>2578WCSA 2578NWCSA C2578WCSA C2578NWCSA</p>	<p><b>1802-2094-003</b></p> <p>2500WCSA 2500NWCSA C2500WCSA C2500NWCSA</p>
<p><b>1802-11021-004</b></p> <p>25726WCA 25726NWCA C25726WCA C25726NWCA</p>	<p><b>1802-11021-005</b></p> <p>25426WCA 25426NWCA C25426WCA C25426NWCA</p>	<p><b>1802-11021-006</b></p> <p>25026WCA 25026NWCA C25026WCA C25026NWCA</p>	<p><b>1802-11021-007</b></p> <p>25126WCA 25126NWCA C25126WCA C25126NWCA</p>	<p><b>1802-2094-004</b></p> <p>25408WCSA 25408NWCSA C25408WCSA C25408NWCSA</p>	<p><b>1802-2094-005</b></p> <p>25708WCSA 25708NWCSA C25708WCSA C25708NWCSA</p>

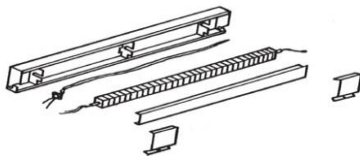



**C2500 & 2500 SERIES CONTINUED**

**FACE PLATE**



COLOR	FEET	GA.	PART NUMBER	COLOR	FEET	GA.	PART NUMBER
NAVAJO	2.5	18	1402-2122-040	NORTHERN WHITE	2.5	18	1402-2122-061
NAVAJO	3	18	1402-2122-041	NORTHERN WHITE	3	18	1402-2122-062
NAVAJO	4	18	1402-2122-042	NORTHERN WHITE	4	18	1402-2122-063
NAVAJO	5	18	1402-2122-043	NORTHERN WHITE	5	18	1402-2122-064
NAVAJO	6	18	1402-2122-044	NORTHERN WHITE	6	18	1402-2122-065
NAVAJO	8	18	1402-2122-045	NORTHERN WHITE	8	18	1402-2122-066
NAVAJO	2	22	1402-2122-635	NORTHERN WHITE	2	22	1402-2122-623
NAVAJO	2.5	22	1402-2122-628	NORTHERN WHITE	2.5	22	1402-2122-616
NAVAJO	3	22	1402-2122-629	NORTHERN WHITE	3	22	1402-2122-617
NAVAJO	4	22	1402-2122-630	NORTHERN WHITE	4	22	1402-2122-618
NAVAJO	5	22	1402-2122-631	NORTHERN WHITE	5	22	1402-2122-619
NAVAJO	6	22	1402-2122-632	NORTHERN WHITE	6	22	1402-2122-620
NAVAJO	8	22	1402-2122-633	NORTHERN WHITE	8	22	1402-2122-621

NOTE: 18GA IS FOR COMERCIAL MODELS

**CONTROL BOX COVER**













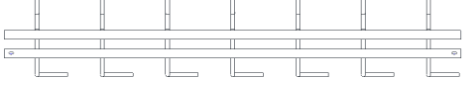





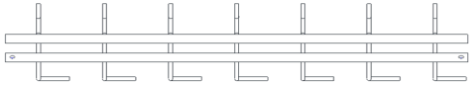

COLOR	GA.	PART NUMBER	COLOR	GA.	PART NUMBER
NAVAJO	24	1402-2261-601	NORTHERN WHITE	24	1402-2261-600
NAVAJO	20	1402-2261-603	NORTHERN WHITE	20	1402-2261-604



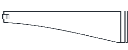

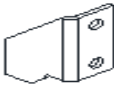
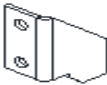
NOTE: 20 GA IS FOR COMERCIAL MODELS

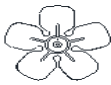
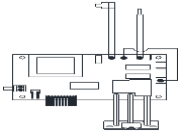
**ACCESSORIES**

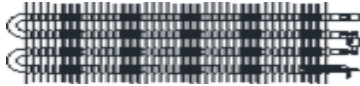
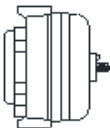

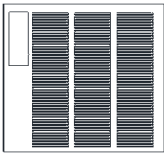

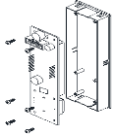
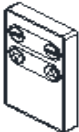
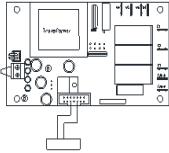
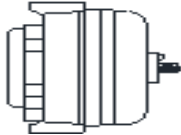

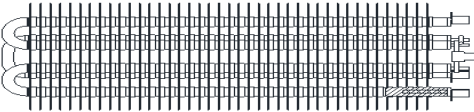
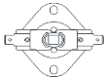
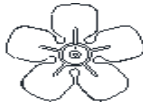
MODEL	KNOB	THERMOSTATS
T1	3301-2011-000	5813-2014-000
T2	3301-2011-000	5813-2015-000
T1A	3301-2014-006	410127001
T2A	3301-2020-004	410128001
T4		410129001
T4A	3301-2014-006	410129001
T5A	3301-2020-004	410130001
TA1AW	42521-032-10	5813-2009-000
TA2AW	42521-032-08	5813-2010-000
TA1ANW	42521-032-11	5813-2009-000
TA2ANW	42521-032-09	5813-2010-000
TA1AWCA	42521-032-10	5813-2009-000
TA2AWCA	42521-032-08	5813-2010-000
TA1ANWCA	42521-032-11	5813-2009-000
TA2ANWCA	42521-032-09	5813-2010-000

HBB SERIES BASEBOARD											
ELEMENT						LIMIT					
											
1802-2068-000	1802-2068-001	1802-2068-002	1802-2068-003	1802-2068-004	1802-2068-016	410122002	410122003	410122004	410122005	410122006	410122008
500D	7500D	1000D	1250D	1500D	2004D	500D	7500D	1000D	1250D	1500D	2004D
500DA	7500DA	1000DA	1250DA	1500DA	2004DA	500DA	7500DA	1000DA	1250DA	1500DA	2004DA
500DB	7500DB	1000DB	1250DB	1500DB	2004DB	500DB	7500DB	1000DB	1250DB	1500DB	2004DB
1802-2068-011	1802-2068-012	1802-2068-013	1802-2068-014	1802-2068-015	1802-2068-010	504D	7504D	1004D	1254D	1504D	2007D
504D	7504D	1004D	1254D	1504D	2008D	504DA	7504DA	1004DA	1254DA	1504DA	2008D
504DA	7504DA	1004DA	1254DA	1504DA	2008DA	504DB	7504DB	1004DB	1254DB	1504DB	2008DA
504DB	7504DB	1004DB	1254DB	1504DB		508D	7507D	1007D	1257D	1507D	2008DB
1802-2068-005	1802-2068-006	1802-2068-007	1802-2068-008	1802-2068-009		508DA	7508DA	1008DA	1258DA	1508DA	
508D	7508D	1008D	1258D	1508D		508DB	7508DB	1008DB	1258DB	1508DB	
508DA	7508DA	1008DA	1258DA	1508DA							
508DB	7508DB	1008DB	1258DB	1508DB							
FRONT COVER						GRILLE					
											
1402-2066-600	1402-2066-601	1402-2066-602	1402-2066-603	1402-2066-604	1402-2066-605	2501-2012-012	2501-2012-013	2501-2012-014	2501-2012-015	2501-2012-010	2501-2012-011
500D	7500D	1000D	1250D	1500D	2004D	500D	7500D	1000D	1250D	1500D	2004D
500DA	7500DA	1000DA	1250DA	1500DA	2004DA	500DA	7500DA	1000DA	1250DA	1500DA	2004DA
500DB	7500DB	1000DB	1250DB	1500DB	2004DB	500DB	7500DB	1000DB	1250DB	1500DB	2004DB
504D	7504D	1004D	1254D	1504D	2007D	504D	7504D	1004D	1254D	1504D	2007D
504DA	7504DA	1004DA	1254DA	1504DA	2008D	504DA	7504DA	1004DA	1254DA	1504DA	2008D
504DB	7504DB	1004DB	1254DB	1504DB	2008DA	504DB	7504DB	1004DB	1254DB	1504DB	2008DA
508D	7507D	1007D	1257D	1507D	2008DB	508D	7507D	1007D	1257D	1507D	2008DB
508DA	7508DA	1008DA	1258DA	1508DA		508DA	7508DA	1008DA	1258DA	1508DA	
508DB	7508DB	1008DB	1258DB	1508DB		508DB	7508DB	1008DB	1258DB	1508DB	
FRONT COVER ALL MODELS 1800-2022-000											
											
CBD SERIES BASEBOARD (OBSOLETE)											
ELEMENT						LIMIT					
											
1802-2056-007	1802-2056-011	1802-2063-017	1802-2063-023	1802-2094-015	1802-2063-033	4520-2018-001	4520-2018-002	4520-2018-003	4520-2018-004	4520-2018-005	4520-2018-006
D500	D750	D1000	D1250	D1500	D2004	D500	D750	D1000	D1250	D1500	D2004
D500A	D750A	D1000A	D1250A	D1500A	D2004A	D500A	D750A	D1000A	D1250A	D1500A	D2004A
1802-2056-005	1802-2056-009	1802-2063-015	1802-2063-021	1802-2063-027	1802-2063-032	D504	D754	D1004A	D1254	D1504	D2007
D504	D754	D1004	D1254	D1504	D2007	D504A	D754A	D1004A	D1254A	D1504A	D2007A
D504B	D754B	D1004B	D1254B	D1504B	D2007B	D507	D757	D1007	D1256	D1507	D2008
1802-2056-004	1802-2056-008	1802-2063-014	1802-2063-047	1802-2063-026	1802-2063-034	D507A	D757A	D1007A	D1256A	D1507A	D2008A
D507	D757	D1007	D1256	D1507	D2008	D508	D758	D1008	D1257	D1508	
D507A	D757A	D1007A	D1256A	D1507A	D2008A	D508A	D758A	D1008A	D1257A	D1508A	
1802-2056-006	1802-2056-010	1802-2063-016	1802-2063-020	1802-2063-028							
D508	D758	D1008	D1257	D1508							
D508A	D758A	D1008A	D1257A	D1508A							
			1802-2063-022								
			D1258								
			D1258A								
FRONT COVER						GRILLE					
											
1402-2066-010	1402-2066-011	1402-2066-012	1402-2066-013	1402-2066-014	1402-2066-015	2501-2012-012	2501-2012-013	2501-2012-014	2501-2012-015	2501-2012-010	2501-2012-011
D500	D750	D1000	D1250	D1500	D2004	D500	D750	D1000	D1250	D1500	D2004
D500A	D750A	D1000A	D1250A	D1500A	D2004A	D500A	D750A	D1000A	D1250A	D1500A	D2004A
D504	D754	D1004	D1254	D1504	D2007	D504	D754	D1004	D1254	D1504	D2007
D504A	D754A	D1004A	D1254A	D1504A	D2007A	D504B	D754B	D1004B	D1254B	D1504B	D2007B
D507	D757	D1007	D1256	D1507	D2008	D507	D757	D1007	D1256	D1507	D2008
D507A	D757A	D1007A	D1256A	D1507A	D2008A	D507A	D757A	D1007A	D1256A	D1507A	D2008A
D508	D758	D1008	D1257	D1508		D508	D758	D1008	D1257	D1508	
D508A	D758A	D1008A	D1257A	D1508A		D508A	D758A	D1008A	D1257A	D1508A	
			D1258								
			D1258A								
FRONT COVER ALL MODELS 1800-2022-000											
											
SEE ACCESSORIES ON 2500 SERIES PAGE FOR T1 & T2 THERMOSTAT PARTS											

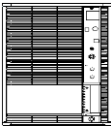
SSAR SERIES							
RIGHT BEZEL	LEFT BEZEL	DISPLAY ASSM.	BOTTOM BRACKET LT.	BOTTOM BRACKET RT.	REMOTE	EOL LIMIT	FAN BLADE
							
1219-11009-001 ALL MODELS	1219-11009-000 ALL MODELS	1016-11188-000 ALL MODELS	1215-11070-000 ALL MODELS	1215-11070-001 ALL MODELS	1414-11037-001 ALL MODELS	1414-11046-000 ALL MODELS	490030103 ALL MODELS
PWR CONTROL BOARD			DISCONNECT SWITCH	ELEMENT			
							
1414-11033-002 ARWH1802 ARWH1802AL ARWH1802BZ ARWH1802W	1414-11033-001 ARWH4807 ARWH4807AL ARWH4807BZ ARWH4807W	1414-11033-000 ARWH4808 ARWH4804 ARWH4808AL ARWH4804AL ARWH4808BZ ARWH4804BZ ARWH4808W ARWH4804W	410170001 ARWH1802 ARWH1802AL ARWH1802BZ ARWH1802W ARWH4804 ARWH4804AL ARWH4804BZ ARWH4804W ARWH4807 ARWH4807AL ARWH4807BZ ARWH4807W	302012828 ARWH1802 ARWH1802AL ARWH1802BZ ARWH1802W	1802-2075-801 ARWH4808 ARWH4808AL ARWH4808BZ ARWH4808W	302012810 ARWH4804 ARWH4804AL ARWH4804BZ ARWH4804W	302012811 ARWH4807 ARWH4807AL ARWH4807BZ ARWH4807W
MOTOR							
3900-11026-002 ARWH1802 ARWH1802AL ARWH1802BZ ARWH1802W	3900-11026-001 ARWH4807 ARWH4807AL ARWH4807BZ ARWH4807W	3900-11026-000 ARWH4808 ARWH4804 ARWH4808AL ARWH4804AL ARWH4808BZ ARWH4804BZ ARWH4808W ARWH4804W					

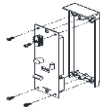
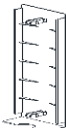
SSHO SERIES						
GRILLE			GRILLE TABS (2 REQ)			LIGHT
						
<b>2501-11022-000</b> HOSS4004 HOSS4007 HOSS4008	<b>2501-11022-001</b> HOSS4004SB HOSS4007SB HOSS4008SB	<b>2501-11022-002</b> HOSS4004NV HOSS4007NV HOSS408NV	<b>1402-2120-002</b> HOSS4004 HOSS4007 HOSS4008	<b>1402-2120-001</b> HOSS4004SB HOSS4007SB HOSS4008SB	<b>1402-2120-000</b> HOSS4004NV HOSS4007NV HOSS408NV	<b>3510-2017-005</b> ALL MODELS
DISPLAY ASSM.	REMOTE	CTRL PWR BOARD		MOTOR		DISCONNECT SWITCH
						
<b>1016-11199-000</b> ALL MODELS	<b>1414-11037-001</b> ALL MODELS	<b>1414-11043-000</b> HOSS4004 HOSS4004NV HOSS4004SB HOSS4008 HOSS408NV HOSS4008SB	<b>1414-11043-001</b> HOSS4007 HOSS4007NV HOSS4007SB	<b>3900-2002-522</b> HOSS4004 HOSS4004NV HOSS4004SB HOSS4008 HOSS408NV HOSS4008SB	<b>3900-2002-523</b> HOSS4007 HOSS4007NV HOSS4007SB	<b>410170001</b> ALL MODELS
ELEMENT			MANUAL LIMIT	FAN BLADE		
						
<b>1802-11005-000</b> HOSS4008 HOSS408NV HOSS4008SB	<b>1802-11005-001</b> HOSS4004 HOSS4004NV HOSS4004SB	<b>1802-11005-002</b> HOSS4007 HOSS4007NV HOSS4007SB	<b>4520-2027-000</b> ALL MODELS	<b>490030103</b> ALL MODELS		

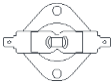
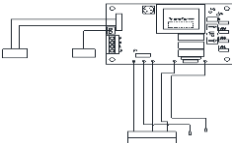
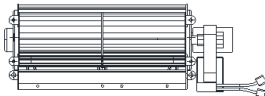
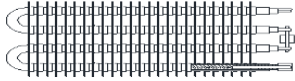
**HT SMART SERIES**











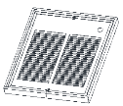

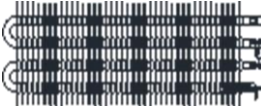

GRILLE PANEL		GRILLE ASSY INSERT		DISPLAY BEZEL	BOTTOM BEZEL	REMOTE	MANUAL LIMIT
							
2501-11003-003 HT1502SS HT2024SS	2501-11003-004 HT1502SSNW HT2024SSNW	1016-11063-000 HT1502SS HT2024SS	1016-11063-001 HT1502SSNW HT2024SSNW	1016-11035-003 HT1502SS HT2024SS HT1502SSNW HT2024SSNW	1219-11004-000 ALL MODELS	1414-11017-001 ALL MODELS	4520-11005-000 ALL MODELS
CNTRL PWR BOARD		BLOWER MOTOR		ELEMENT		LIGHT	
							
1414-11007-002 HT1502SS HT1502SSNW	1414-11007-003 HT2024SS HT2024SSNW	1225-11001-000 HT1502SS HT1502SSNW	1225-11001-001 HT2024SS HT2024SSNW	302023802 HT1502SS HT1502SSNW	302023805 HT2024SS HT2024SSNW	3510-2010-000 HT1502SS HT1502SSNW	3510-2010-001 HT2024SS HT2024SSNW
							

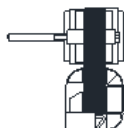

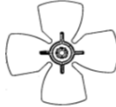

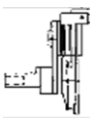



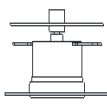







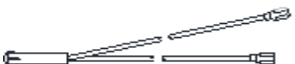
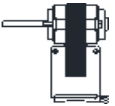

















CWH3000 SERIES																							
KNOB		GRILLE			MOTOR			FAN BLADE															
<b>3301-11014-001</b> WHB3150FC WHB3180C WHB3307FC WHB3404FC WHB34043FC WHB3407FC WHB3408FC WHB34083FC WHB3504FC WHB35043FC WHB3507FC WHB3508FC WHB35083FC		<b>3301-2016-000</b> CWH3157A CWH3204A CWH3207A CWH3208A CWH3307A CWH3404A CWH3407A CWH3408A CWH3504A CWH3507A CWH3157AWW CWH3204AWW CWH3207AWW CWH3208AWW CWH3307AWW CWH3404AWW CWH3407AWW CWH3408AWW CWH3504AWW CWH3507AWW			<b>1016-11226-000</b> WHB3150FC WHB3180C WHB3307FC WHB3404FC WHB34043FC WHB3407FC WHB3408FC WHB34083FC WHB3504FC WHB35043FC WHB3507FC WHB3508FC WHB35083FC			<b>2501-2019-001</b> CWH3157AWW CWH3204AWW CWH3207AWW CWH3208AWW CWH3307AWW CWH3404AWW CWH3407AWW CWH3408AWW CWH3504AWW CWH3507AWW CWH3157BNW CWH3204BNW CWH3207BNW CWH3208BNW CWH3307BNW CWH3404BNW CWH3407BNW CWH3408BNW CWH3504BNW CWH3507BNW			<b>3900-2010-001</b> CWH3157A CWH3207A CWH3307A CWH3407A CWH3507A CWH3157AWW CWH3207AWW CWH3307AWW CWH3407AWW CWH3507AWW CWH3157BNW CWH3207BNW CWH3307BNW CWH3407BNW CWH3507BNW WHB3307FC WHB3407FC WHB3507FC			<b>3900-2010-000</b> CWH3204A CWH3208A CWH3404A CWH3408A CWH3504A CWH3204AWW CWH3208AWW CWH3404AWW CWH3408AWW CWH3504AWW CWH3204BNW CWH3208BNW CWH3404BNW CWH3408BNW CWH3504BNW WHB3404FC WHB3408FC WHB3504FC			<b>3900-2010-003</b> CWH3150 CWH3180 WHB3150FC WHB3180C <b>3900-2002-510</b> CWH3153BNW CWH3156BNW CWH3203BNW CWH3206BNW <b>3900-2002-519</b> CWH3406 CWH3503 CWH3506 CWH3204BNW CWH3208BNW CWH3503BNW CWH3506BNW			<b>3900-2002-518</b> CWH34043 CWH34083 CWH35043 CWH35083 CWH34043BNW CWH34083BNW CWH35043BNW CWH35083BNW WHB34043FC WHB34083FC WHB35043FC WHB35083FC		<b>490030103</b> ALL MODELS	
<b>ELEMENT</b>					<b>THERMOSTAT</b>			<b>MANUAL LIMIT</b>	<b>TIME DELAY RELAY</b>														
<b>302015801</b> CWH3208A CWH3208AWW CWH3208BNW		<b>302015802</b> CWH3204A CWH3204AWW CWH3204BNW	<b>302015803</b> CWH3207A CWH3207AWW CWH3207BNW	<b>302015806</b> CWH3157A CWH3157AWW CWH3157BNW	<b>1802-2075-801</b> CWH35083 CWH3508BNW CWH35083BNW WHB3508FC WHB35083FC	<b>410168002</b> CWH3157A CWH3204A CWH3207A CWH3208A CWH3307A CWH3404A CWH3407A CWH3408A CWH3504A CWH3507A CWH3204AWW CWH3207AWW CWH3208AWW CWH3307AWW CWH3404AWW CWH3407AWW CWH3408AWW CWH3504AWW CWH3507AWW CWH34043		<b>5813-2059-000</b> CWH3150 CWH3180 CWH3153BNW CWH3156BNW CWH3157BNW CWH3203BNW CWH3204BNW CWH3206BNW CWH3207BNW CWH3208BNW CWH3303BNW CWH3306BNW CWH3307BNW CWH3308BNW CWH3404BNW CWH34043BNW CWH3406BNW CWH3407BNW CWH3408BNW CWH3503BNW		<b>4520-2027-000</b> ALL MODELS	<b>410171003</b> CWH3203BNW CWH3206BNW												
<b>302012806</b> CWH3307A CWH3307AWW CWH3307BNW WHB3307FC		<b>302012807</b> CWH3408A CWH3408AWW CWH3408BNW WHB3408FC	<b>302012808</b> CWH3404A CWH3404AWW CWH3404BNW WHB3404FC	<b>302012809</b> CWH3407A CWH3407AWW CWH3407BNW WHB3407FC	<b>1802-2075-803</b> CWH35043 CWH35043BNW WHB35043FC	<b>41012823</b> CWH3180 WHB3180C		<b>1802-2075-800</b> CWH34083 CWH34083BNW WHB34083FC	<b>4520-2048-000</b> WHB34043FC WHB3507FC WHB35083FC WHB34083FC WHB35083FC														
<b>302012810</b> CWH3504A CWH3504AWW CWH3504BNW WHB3504FC		<b>302012811</b> CWH3507A CWH3507AWW CWH3507BNW WHB3507FC	<b>302012823</b> CWH3503 CWH3503BNW	<b>302012828</b> CWH3180 WHB3180C	<b>1802-2075-802</b> CWH34043 CWH34043BNW WHB34043FC	<b>41012822</b> CWH3150 WHB3150FC		<b>4520-2048-000</b> WHB34043FC WHB3507FC WHB35083FC WHB34083FC WHB35083FC															
<b>DISCONNECT SWITCH</b>					<b>FAN DELAY</b>			<b>RELAY MODELS BEFORE 2020</b>	<b>TRANSFORMER</b>														
<b>5216-2019-000</b> CWH34043 CWH3406 CWH34083 CWH3503 CWH35043 CWH3506 CWH35083 CWH3153BNW CWH3156BNW CWH3203BNW CWH3206BNW CWH3303BNW CWH3306BNW CWH3308BNW CWH34043BNW CWH3406BNW CWH34083BNW CWH3503BNW CWH35043BNW CWH3506BNW CWH3508BNW		<b>410170001</b> CWH3157A CWH3204A CWH3207A CWH3208A CWH3307A CWH3404A CWH3407A CWH3408A CWH3504A CWH3507A CWH3157AWW CWH3204AWW CWH3207AWW CWH3208AWW CWH3307AWW CWH3404AWW CWH3407AWW CWH3408AWW CWH3504AWW CWH3507AWW CWH3157BNW CWH3204BNW CWH3207BNW CWH3208BNW CWH3307BNW CWH3404BNW CWH3407BNW CWH3408BNW CWH3504BNW CWH3507BNW WHB3150FC WHB3180C WHB3307FC WHB3404FC WHB3407FC WHB3408FC WHB3504FC WHB3507FC			<b>4520-2024-000</b> CWH34043 CWH34083 CWH35043 CWH35083 CWH3153BNW CWH3156BNW	<b>410074000</b> CWH3157A CWH3204A CWH3207A CWH3208A CWH3307A CWH3404A CWH3407A CWH3408A CWH3504A CWH3507A CWH3157AWW CWH3204AWW CWH3207AWW CWH3208AWW CWH3307AWW CWH3404AWW CWH3407AWW CWH3408AWW CWH3504AWW CWH3507AWW CWH3406 CWH3406BNW CWH3506BNW CWH3507BNW CWH3508BNW CWH35083BNW WHB3150FC WHB3180C WHB3307FC WHB3404FC WHB34043FC WHB3407FC WHB3408FC WHB3504FC WHB35043FC WHB3507FC WHB3508FC WHB35083FC		<b>5018-2017-000</b> CWH34043 CWH35043 CWH3153BNW CWH3156BNW CWH3203BNW CWH3206BNW CWH3306BNW CWH3403BNW CWH35043BNW	<b>5018-2017-004</b> CWH34083 CWH35083 CWH34083BNW CWH35083BNW CWH35083BNW	<b>490015017</b> CWH3156BNW CWH3206BNW CWH3306BNW CWH3406BNW CWH3506BNW	<b>490015013</b> CWH3153BNW CWH3203BNW CWH3303BNW CWH3308BNW CWH3503BNW												
<b>RELAY</b>					<b>410101002</b>			<b>WHB</b>	<b>CWH</b>														





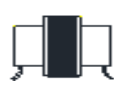
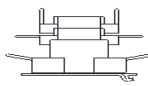





**CWH1000 SERIES**



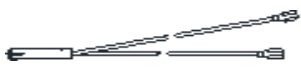

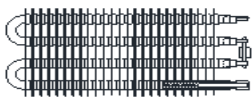
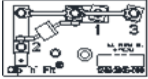
GRILLE		KNOB		ELEMENT			
							
<b>2501-2058-000</b>	<b>1016-11228-000</b>	<b>3301-2001-000</b>	<b>3301-11015-001</b>	<b>302023801</b>	<b>302023802</b>	<b>302023803</b>	
CWH1101DS CWH1151DS CWH1157DS CWH1201DS CWH1202DS CWH1207DS CWH1208DS CWH1101DSA CWH1151DSA CWH1157DSA CWH1201DSA CWH1202DSA CWH1207DSA CWH1208DSA	WHB1101FC WHB1151FC WHB1157FC WHB1201FC WHB1202FC WHB1207FC WHB1208FC	CWH1101DS CWH1151DS CWH1157DS CWH1201DS CWH1202DS CWH1207DS CWH1208DS CWH1101DSA CWH1151DSA CWH1157DSA CWH1201DSA CWH1202DSA CWH1207DSA CWH1208DSA	WHB1101FC WHB1151FC WHB1157FC WHB1201FC WHB1202FC WHB1207FC WHB1208FC	CWH1101DS CWH1101DSA WHB1101FC <b>302023804</b> CWH1208DS CWH1208DSA WHB1208FC <b>302023808</b> CWH1201DS CWH1201DSA WHB1201FC	CWH1151DS CWH1151DSA WHB1151FC <b>302023805</b> CWH1202DS CWH1202DSA WHB1202FC	CWH1157DS CWH1157DSA WHB1157FC <b>302023806</b> CWH1207DS CWH1207DSA WHB1207FC	
<b>LIGHT</b>		<b>MOTOR</b>		<b>DISCONNECT SWITCH</b>	<b>FAN BLADE</b>		
							
<b>3510-2017-007</b>	<b>3510-2017-006</b>		<b>490062001</b>	<b>490062003</b>	<b>410170001</b>	<b>490061001</b>	
CWH1101DS CWH1151DS CWH1201DS CWH1101DSA CWH1151DSA CWH1201DSA WHB1101FC WHB1151FC WHB1201FC	CWH1157DS CWH1157DSA CWH1207DS CWH1101DSA CWH1151DSA CWH1202DSA CWH1208DS CWH1208DSA WHB1157FC WHB1202FC WHB1207FC WHB1208FC		CWH1101DS CWH1151DS CWH1201DS CWH1101DSA CWH1151DSA CWH1201DSA WHB1101FC WHB1151FC WHB1201FC <b>490062002</b> CWH1208DS CWH1208DSA CWH1208FC	CWH1202DS CWH1202DSA WHB1202FC <b>490062004</b> CWH1157DS CWH1207DS CWH1157DSA CWH1207DSA WHB1157FC WHB1207FC	ALL MODELS	ALL MODELS	
				<b>CWH</b>	<b>WHB</b>		
							
<b>THERMOSTAT</b>	<b>THERMAL FUSE</b>	<b>FAN DELAY</b>	<b>HI LIMIT</b>	<b>MANUAL LIMIT</b>			
							
<b>5813-2001-000</b>	<b>5813-2022-000</b>	<b>4520-2030-000</b>	<b>410074000</b>	<b>410143000</b>	<b>4520-11016-000</b>		
CWH1101DS CWH1151DS CWH1157DS CWH1202DS CWH1207DS CWH1208DS CWH1101DSA CWH1151DSA CWH1157DSA CWH1202DSA CWH1207DSA CWH1208DSA WHB1101FC WHB1151FC WHB1157FC WHB1202FC WHB1207FC WHB1208FC	CWH1201DS CWH1201DSA WHB1201FC	CWH1101DSA CWH1151DSA CWH1157DSA CWH1201DSA CWH1202DSA CWH1207DSA CWH1208DSA WHB1101FC WHB1151FC WHB1157FC WHB1201FC WHB1202FC WHB1207FC WHB1208FC	ALL MODELS	CWH1101DS CWH1151DS CWH1157DS CWH1201DS CWH1202DS CWH1207DS CWH1208DS	CWH1101DSA CWH1151DSA CWH1157DSA CWH1201DSA CWH1202DSA CWH1207DSA CWH1208DSA WHB1101FC WHB1151FC WHB1157FC WHB1201FC WHB1202FC WHB1207FC WHB1208FC		

**CWH ARCHITECTURAL SERIES (SWH)**



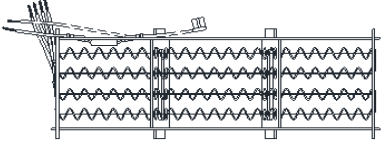
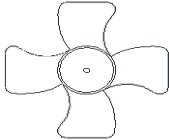
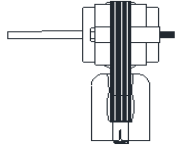

KNOB		GRILLE		ELEMENT		
						
<b>3301-11015-003</b> SWH1012FC SWH1512FC SWH1527FC SWH1812FC SWH2020FC SWH2024FC SWH2027FC	<b>3301-2052-002</b> SWH1012AG SWH1512AG SWH1527AG SWH1812AG SWH2020AG SWH2024AG SWH2027AG SWH1012AGA SWH1512AGA SWH1527AGA SWH1812AGA SWH2020AGA SWH2024AGA SWH2027AGA	<b>1016-11227-000</b> SWH1012FC SWH1512FC SWH1527FC SWH1812FC SWH2020FC SWH2024FC SWH2027FC	<b>2501-2075-000</b> SWH1012AG SWH1512AG SWH1527AG SWH1812AG SWH2020AG SWH2024AG SWH2027AG SWH1012AGA SWH1512AGA SWH1527AGA SWH1812AGA SWH2020AGA SWH2024AGA SWH2027AGA	<b>302023801</b> SWH1012AG SWH1012AGA SWH1012FC	<b>302023802</b> SWH1512AG SWH1512AGA SWH1512FC	<b>302023803</b> SWH1527AG SWH1527AGA SWH1527FC
				<b>302023804</b> SWH2020AG SWH2020AGA SWH2020FC	<b>302023805</b> SWH2024AG SWH2024AGA SWH2024FC	<b>302023806</b> SWH2027AG SWH2027AGA SWH2027FC
				<b>302023808</b> SWH1812AG SWH1812AGA SWH1812FC		
LIGHT				MOTOR	DISCONNECT SWITCH	
						
<b>3510-2008-002</b> SWH1527AG	<b>3510-2008-003</b> SWH1012AG SWH1512AG SWH1812AG SWH2020AG SWH2024AG SWH2027AG	<b>3510-2017-007</b> SWH1012AGA SWH1512AGA SWH1812AGA SWH1012FC SWH1512FC SWH1812FC	<b>3510-2017-006</b> SWH1527AGA SWH2020AGA SWH2024AGA SWH2027AGA SWH1527FC SWH2020FC SWH2024FC SWH2027FC	<b>490062001</b> SWH1012AG SWH1512AG SWH1812AG SWH1012AGA SWH1512AGA SWH1812AGA SWH1012FC SWH1512FC SWH1812FC	<b>490062003</b> SWH2024AG SWH2024AGA SWH2024FC	<b>410170001</b> ALL MODELS
				<b>490062002</b> SWH2020AG SWH2020AGA SWH2020FC	<b>490062004</b> SWH1527AG SWH2027AG SWH1527AGA SWH2027AGA SWH1527FC SWH2027FC	
FAN DELAY	HI LIMIT	MANUAL LIMIT	FAN BLADE	THERMAL FUSE	THERMOSTAT	
						
<b>410074000</b> ALL MODELS	<b>410143000</b> SWH1012AG SWH1512AG SWH1527AG SWH1812AG SWH2020AG SWH2024AG SWH2027AG	<b>4520-11016-000</b> SWH1012AGA SWH1512AGA SWH1527AGA SWH1812AGA SWH2020AGA SWH2024AGA SWH2027AGA SWH1012FC SWH1512FC SWH1527FC SWH1812FC SWH2020FC SWH2024FC SWH2027FC	<b>490061001</b> ALL MODELS	<b>4520-2030-000</b> SWH1012AGA SWH1512AGA SWH1527AGA SWH1812AGA SWH2020AGA SWH2024AGA SWH2027AGA SWH1012FC SWH1512FC SWH1527FC SWH1812FC SWH2020FC SWH2024FC SWH2027FC	<b>5813-2022-000</b> SWH1812AG SWH1812AGA SWH1812FC	<b>5813-2001-000</b> SWH1012AG SWH1512AG SWH1527AG SWH2020AG SWH2024AG SWH2027AG SWH1012AGA SWH1512AGA SWH1527AGA SWH2020AGA SWH2024AGA SWH2027AGA SWH1012FC SWH1512FC SWH1527FC SWH2020FC SWH2024FC SWH2027FC
<b>SWH-AG</b> 	<b>SWH-FC</b> 					

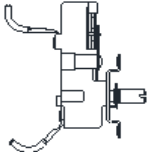
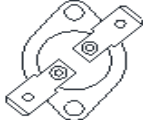
LFK-SERIES										
GRILLE			KNOB			FAN DELAY			MANUAL LIMIT	
										
<b>1402-2239-000</b> K151 K157A K204A K207A K208A K303A K304A K306A K307A K403A K404A K4043A K406A K407A K408A K4083A K483A K484A K4843A K486A K487A K488A K4883A	<b>1402-2152-000</b> K204 K207 K208 K303 K304 K306 K307 K403 K404 K4083FC K406 K408 K4083 K483 K484 K4843 K486 K487 K488 K4883	<b>2501-11028-000</b> K151FC K204FC K207A K304FC K306FC K403FC K404FC K406FC K408FC K4083FC K483FC K484FC K486FC K487FC K488FC K4883FC	<b>3301-2030-001</b> K151 K204 K207A K208A K303 K304 K306A K307A K403 K404 K4043A K406A K407A K408A K4083A K483 K484A K486A K487A K488A K4883A K157A		<b>3301-11014-001</b> K151FC K204FC K303FC K304FC K306FC K403FC K404FC K406FC K408FC K4083FC K483FC K484FC K486FC K487FC K488FC K4883FC	<b>4520-2024-000</b> K4043 K4043A K4083 K4083A K4083FC K4843 K4843A K488 K4883 K488A K4883A K4883FC	<b>410074000</b> K204 K204A K204FC K208 K208A K303 K303A K303FC K304 K304A K306 K306A K306FC K403 K403A K403A K404 K404A K404A K406 K406A		K406FC K408 K408A K408FC K483 K483A K483FC K484 K484A K484FC K486 K486A K486FC K207 K207A K307 K307A K487 K487A K487A K487A K487A K157A K407A	<b>4520-2027-000</b> ALL MODELS
<b>ELEMENTS</b> 			<b>MOTOR</b> 				<b>FAN BLADE</b> 			
<b>302012827</b> K151 K151FC	<b>302015802</b> K204 K204A K204FC	<b>302015803</b> K207 K207A	<b>302015801</b> K208 K208A	<b>3900-2010-003</b> K151 K151FC	<b>3900-2010-000</b> K204 K204A K204FC K208 K208A K303 K303A K303FC K304 K304A K304FC K306 K306A K306FC K403 K403A K403FC K404	<b>3900-2010-001</b> K404A K404FC K406 K406A K406FC K408 K408A K408FC K483 K483A K483A K483FC K484 K484A K484A K486 K486A K486FC	<b>3900-2002-518</b> K207 K207A K307 K307A K487 K487A K487FC K157A K407A	<b>490030103</b> ALL MODELS	K4043 K4043A K4083 K4083A K4083FC K4843 K4843A K487FC K488 K4883 K488A K4883A K4883A K4883FC	
<b>302012819</b> K303 K303A K303FC	<b>302012820</b> K304 K306 K306A K306FC	<b>302012809</b> K304 K304A K304FC K407A	<b>302012806</b> K307 K307A	<b>302012808</b> K404 K404A K404FC	<b>302012807</b> K408 K408A K408FC					
<b>302012821</b> K403 K403A K403FC	<b>1802-2075-802</b> K4043 K4043A	<b>1802-2075-800</b> K4083 K4083A K4083FC								
<b>302012822</b> K406 K406A K406FC	<b>302012823</b> K483 K483A K483FC	<b>302012810</b> K484 K484A K484FC		<b>1802-2075-803</b> K4843 K4843A						
<b>302012824</b> K486 K486A K486FC	<b>302012811</b> K487 K487A K487FC	<b>1802-2075-801</b> K488 K488A K4883A K4883A K4883FC								
<b>302015806</b> K157A										
<b>THERMOSTAT</b> 			<b>TRANSFORMER</b> 			<b>RELAY</b> 		<b>RELAY MODELS BEFORE 2020</b> 		
<b>410168002</b> K4043 K4043A K4843 K4843A	<b>5813-2027-000</b> K204 K204A K204FC K208 K303 K303A K303FC K304 K304A K304FC K306 K306A K306FC K403 K403A K403FC K404 K404A	<b>5813-2027-000</b> K404FC K406 K406A K406FC K408 K408A K408FC K483 K483A K483A K484 K484A K484A K486 K486A K486A K486A K486A K207	K207A K307 K307A K487 K487A K487A K157A K407A K4083 K4083A K4083A K4083FC K488 K488A K488A K488A K488A K4883A K4883A K4883A K4883FC	<b>490015017</b> K303 K403 K483 K303A K403A K483A K303FC K403FC K483FC	<b>490015013</b> K306 K406 K486 K306A K406A K486A K306FC K406FC K486FC	<b>410101002</b> K4043 K4043A K4843 K4843A	K4083 K4083A K4083FC K488 K4883 K488A K488A K4883A K4883A K4883FC	<b>5018-2017-000</b> K4043 K4043A K4843 K4843A	<b>5018-2017-004</b> K4083 K4083A K4083FC K488 K4883 K488A K4883A K4883A K4883FC	
						<b>LFK-F</b> 	<b>LFK</b> 			



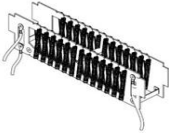
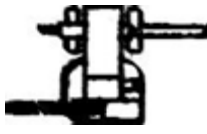







GFR SERIES								
KNOB		GRILLE			LIGHT			
								
<b>3301-2014-004</b> R1500T2 R2004T2 R2404T2 R1500T2A R2004T2A R2404T2A R1500T2B R2004T2B R2404T2B	<b>3301-11015-002</b> R1500T2FC R2004T2FC R2404T2FC	<b>2501-11031-000</b> R1500FC R1500T2FC R2004FC R2004IFFC R2004T2FC R2404FC R2404IFFC R2404T2FC	<b>2501-2026-000</b> R1500 R1500T2 R2004 R2004IF R2004T2 R2404 R2404IF R2404T2 R1500A R1500T2A R2004A R2004IFA R2404T2A R1500B R1500T2B R2004B R2004IFB R2004T2B R2404B R2404IFB R2404T2B		<b>3510-2010-000</b> R1500 R1500T2 R1500A R1500T2A R1500B R1500T2B R1500FC R1500T2FC	<b>3510-2010-001</b> R2004 R2004IF R2004T2 R2004A R2004IFA R2004T2A R2004B R2004IFB R2004T2B R2004FC R2004IFFC R2004T2FC		R2404 R2404IF R2404T2 R2404A R2404IFA R2404T2A R2404B R2404IFB R2404T2B R2404FC R2404IFFC R2404T2FC
<b>BLOWER ASM.</b> 				<b>ELEMENT</b> 			<b>CLIP N FIT BOARD</b> 	
<b>1225-2002-000</b> R1500 R1500T2 R1500A R1500T2A R1500B R1500T2B R1500FC R1500T2FC	R2404A R2404IFA R2404T2A R2404B R2404IFB R2404T2B R2404FC R2404IFFC R2404T2FC	<b>1225-2002-001</b> R2004 R2004IF R2004T2 R2404 R2404IF R2404T2 R2004A R2004IFA R2004T2A	R2004B R2004IFB R2004T2B R2004FC R2004IFFC R2004T2FC	<b>302023802</b> R1500 R1500T2 R1500A R1500T2A R1500B R1500T2B R1500FC R1500T2FC	<b>302023805</b> R2004 R2004IF R2004T2 R2004A R2004IFA R2004T2A R2004B R2004IFB R2004T2B R2004FC R2004IFFC R2004T2FC	<b>302023814</b> R2404 R2404IF R2404T2 R2404A R2404IFA R2404T2A R2404B R2404IFB R2404T2B R2404FC R2404IFFC R2404T2FC	<b>1249-2005-000</b> ALL MODELS	
<b>THERMOSTAT</b> 	<b>TEMPERATURE REGULATOR</b> 			<b>HI-LIMIT</b> 				
<b>410130001</b> R1500T2 R2004T2 R2404T2 R1500T2A R2004T2A R2404T2A R1500T2B R2004T2B R2404T2B R1500T2FC R2004T2FC R2404T2FC	<b>410143000</b> R1500 R1500T2 R2004 R2004IF R2004T2 R1500A R1500T2A R2004A R2004IFA R2004T2A		<b>4520-2029-000</b> R2404 R2404IF R2404T2 R2404A R2404IFA R2404T2A R2404B R2404IFB R2404T2B R2404FC R2404IFFC R2404T2FC	<b>4520-2025-000</b> R1500 R1500T2 R2004 R2004IF R2004T2 R1500A R1500T2A R2004A R2004IFA R2004T2A	<b>4520-2025-001</b> R2404 R2404IF R2404T2 R2404A R2404IFA R2404T2A	<b>4520-11010-000</b> R1500B R1500T2B R1500FC R1500T2FC	<b>4520-11010-001</b> R2004B R2004IFB R2004T2B R2004FC R2004IFFC R2004T2FC R2404B R2404IFB R2404T2B R2404FC R2404IFFC R2404T2FC	





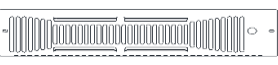

SED SERIES					
KNOB		GRILLE		LIGHT	
					
<b>3301-2044-001</b> D1012C D1024C D1012CA D1024CA	<b>3301-2039-002</b> D1012W D1512 D2024 D1012WA D1024WA D1512A D2024A	<b>2501-2054-001</b> D1012C D1024C D1512CR D1012CA D1024CA D1512CRA	<b>2501-2054-000</b> D1012W D1512 D2024 D1012WA D1024WA D1512A D2024A	<b>3510-2017-002</b> D1012C D1012W D1512 D1512CR D1012CA D1012WA D1512A D1512CRA	<b>3510-2017-003</b> D1024C D2024 D1024CA D1024WA D2024A
ELEMENT			FAN BLADE	MOTOR	
					
<b>1802-2124-003</b> D1012C D1012W D1012CA D1012WA	<b>1802-2124-005</b> D1024C D2024 D1024CA D1024WA D2024A	<b>1802-2124-000</b> D1512 D1512CR D1512A D1512CRA	<b>1210-2008-000</b> ALL MODELS	<b>3900-2037-000</b> D1012C D1012W D1512 D1512CR D1012CA D1012WA D1512A D1512CRA	<b>3900-2037-001</b> D1024C D2024 D1024CA D1024WA D2024A
THERMOSTAT		LIMIT			
					
<b>410130001</b> D1012C D1012W D1512 D1012CA D1012WA D1512A D1024C D2024		<b>4520-11009-000</b> D1012C D1012W D1512 D1512CR D1024C D2024		<b>4520-11009-001</b> D1024CA D1024WA D2024A	



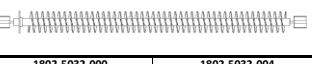

## COZ-E WALL HEATER

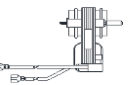









ELEMENT (INCLUDES LIMIT & ONE SHOT FUSE)		MOTOR		GRILLE
				
<b>1802-11014-011</b> CZ1012T	<b>1802-11014-010</b> CZ1512T	<b>3900-11032-000</b> CZ1012IF CZ1012T CZ1512IF CZ1512T	<b>3900-11032-001</b> CZ1048IF CZ1048T CZ1548IF CZ1548T CZ2048IF CZ2048T	<b>2501-11024-000</b> ALL MODELS
<b>1802-11014-014</b> CZ1048T	<b>1802-11014-013</b> CZ1548T			
	<b>1802-11014-012</b> CZ2048T			
THERMOSTAT	FAN IMPELLER	PARTS KIT		
		PICTURE NOT AVAILABLE		
<b>5813-2090-000</b> CZ1012T CZ1048T CZ1512T CZ1548T CZ2048T	<b>2002-11004-000</b> ALL MODELS	<b>1205-11028-500</b> CZ1012T CZ1048T CZ1512T CZ1548T CZ2048T		

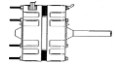



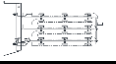







QTS SERIES							
ELEMENTS		MOTOR ASSEMBLY		HI-LIMIT	SELF HOLD LIMIT	FAN DELAY	
							
<b>302023811</b> S1100 S1100A S1100B S1100C S1100CNW	<b>302023803</b> S1104 S1104A S1104B S1104C S1104CNW	<b>1225-2002-000</b> S1100 S1100A S1100B S1100C S1100CNW	<b>1225-2002-001</b> S1104 S1104A S1104B S1104C S1104CNW	<b>4520-2031-000</b> S1100 S1100A S1100B S1104 S1104A S1104B S1500 S1500A S1500B S1500C S1500T S1500TA S1500TB S1500TC S1500TCNW	<b>4520-11011-000</b> S1100C S1100CNW S1500C S1500TC S1500TCNW	<b>1414-2020-000</b> S1100 S1100A S1104 S1104A S1500 S1500A S1500T S1500TA S1504 S1504A S1504TA	<b>410074000</b> S1100B S1100C S1100CNW S1104B S1104C S1104CNW S1500B S1500C S1500TB S1500TC S1500TCNW S1504B S1504C S1504TB S1504TCNW
<b>302023802</b> S1500 S1500A S1500B S1500C S1500T S1500TA S1500TB S1500TC S1500TCNW		<b>302023806</b> S1504 S1504A S1504B S1504C S1504T S1504TA S1504TB S1504TC S1504TCNW		S1500 S1500A S1500B S1500C S1500T S1500TA S1500TB S1500TC S1500TCNW	S1504 S1504A S1504B S1504C S1504T S1504TA S1504TB S1504TC S1504TCNW	S1500A S1500T S1500TA S1504 S1504A S1504TA	S1500B S1500C S1500TB S1500TC S1500TCNW S1504B S1504C S1504TB S1504TCNW
PILOT LIGHT		GRILLE		THERMOSTAT	KNOB	THERMAL CUTOFF	
							
<b>3510-2010-000</b> S1100A S1100B S1100C S1100CNW S1500A S1500B S1500C S1500TA S1500TB S1500TC S1500TCNW	<b>3510-2010-001</b> S1104 S1104A S1104B S1104C S1104CNW S1504 S1504A S1504B S1504C S1504TA S1504TB S1504TC S1504TCNW	<b>2501-2039-000</b> S1100 S1100A S1100B S1100C S1104 S1104A S1104B S1104C S1500 S1500A S1500B S1500C S1500TA S1500TB		<b>2501-2039-001</b> S1500TC S1504 S1504A S1504B S1504C S1504T S1504TA S1504TB S1504TC	<b>410129001</b> S1500T S1500TA S1500TB S1500TC S1500TCNW S1504T S1504TA S1504TB S1504TC S1504TCNW	<b>3301-2020-006</b> S1500T S1500TA S1500TB S1500TC S1500TCNW S1504T S1504TA S1504TB S1504TC S1504TCNW	<b>4520-2030-000</b> ALL MODELS 



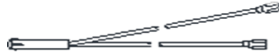





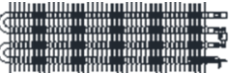
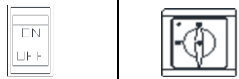

FDI SERIES				
BLADE	ELEMENT		GRILLE	BUZZER
				
<b>1210-0046-000</b> I1500 I1504	<b>1802-5032-000</b> I1500	<b>1802-5032-004</b> I1504	<b>2501-5016-001</b> I1500 I1504	<b>2714-2001-001</b> I1500 I1504
MOTOR		ONE SHOT FUSE BLUE DOT	HI LIMIT WHITE DOT	
				
<b>3900-2025-000</b> I1500	<b>3900-2025-001</b> I1504	<b>4520-2041-000</b> I1500 I1504	<b>4520-5015-001</b> I1500 I1504	

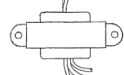







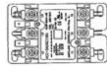

WHT SERIES PUMP HOUSE HEATER			
ELEMENT	KNOB	THERMOSTAT	
			
1802-2091-000	3301-2020-006	5813-2062-000	

CFWF (OBSOLETE)					
TOP FRONT PANEL	BOTTOM FRONT PANEL	TOP TRIM PANEL	MOTOR	RELAY	TRANSFORMER
					
<b>1402-2312-000</b> CFWF920 CFWF920A	<b>1402-2313-000</b> CFWF920 CFWF920A	5806-2004-000 CFWF920 CFWF920A	3900-2036-000 CFWF920 CFWF920A	5018-2017-001 CFWF920 CFWF920A	5814-0003-000 CFWF920 CFWF920A
HI-LIMIT	MANUAL RESET LIMIT	ELEMENT	FAN BLADE	PILOT LIGHT	CERAMIC LIMITS
					
4520-2053-000 CFWF920	4520-2027-000 CFWF920A	1802-2117-101 CFWF920 CFWF920A	1210-2009-001 CFWF920 CFWF920A	3510-2018-000 CFWF920 CFWF920A	4520-2052-000 CFWF920 CFWF920A

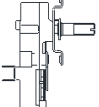

QCH (U SERIES)						
GRILLE		PLASTIC COVER (2 REQ)	ELEMENTS		MOTOR	
						
1402-2121-000 U1000 U1000A U1500 U1500A U1507 U1800 U2004 U2004A U2007 U2007A U2008	1016-11228-001 U1000FA U1500FA U2004FA U2007FA	1402-2119-000 U1000 U1000A U1500 U1500A U1507 U1800 U2004 U2004A U2007 U2007A U2008	302023812 U1000 U1000A U1000FA	302023803 U1507 <del>302023806</del> U1800	490062001 U1000 U1000A U1000FA U1500 U1500A U1500FA U1800	490062003 U2004 U2004A U2004FA  490062004 U1500 U2007 U2007A U2007FA  490062002 U2008
LIGHT		FAND DELAY	HI-LIMIT	FAND BLADE	DISCONNECT SW	SOCKET ASSEMBLY
						
3510-2008-003 U1000A U1000FA U1500A U1500FA	3510-2008-002 U2004A U2004FA U2007A U2007FA	410074000 ALL MODELS	410143000 ALL MODELS	490061001 ALL MODELS	410170001 ALL MODELS	480108903 ALL MODELS

EFF (F SERIES)						
MOTOR		ELEMENT			DISCONNECT	
						
3900-2002-520 F1500	3900-2002-500 F2004	302012827 F1500	302012821 F4003	302012811 F4807	410170001 F1500	5216-2019-000 F3003
3900-2002-501 F1507 F2007 F3007 F4007 F4807	F2008 F3003 F3006 F4003 F4004 F4006 F4008	302015806 F1507	302012808 F4004	1802-2075-802 F40043	F1507 F2004 F2007 F2008 F3007 F4004 F4007 F4008 F4804 F4807	F3006 F4003 F40043 F4006 F40083 F4803 F48043 F4806 F4808 F48083 F48483LV
3900-2002-518 F40043 F40083 F4804 F4808 F48083	F4008 F4803 F4804 F4806	302015803 F2004 302015803 F2007	302012809 F4007	1802-2075-803 F48043		
	3900-2010-000 F48483 F48483LV	302015801 F2008	302012807 F4008	1802-2075-801 F4808 F48083		
		302012819 F3003	302012823 F4803	1802-2075-804 F48483 F48483LV		
		302012820 F3006 302012806 F3007	302012810 F4804 302012824 F4806			
POWER TR.	SECONDARY TR.	RELAY MODELS BEFORE 2020	RELAY	AUTO LIMIT	HI-LIMIT	FAN DELAY
						
490015017 F3003 F4003 F4803	490065002 F48483LV	5018-2017-000 F40043 F48043 F48483	410101002 F40043 F48043 F48483 F4808 F48083	4520-2048-000 F40043 F48043 F48483 F4808 F48083	410169001 ALL MODELS F48043 F4808 F48083	410074000 ALL MODELS
490015013 F3006 F4006 F4806		5018-2017-004 F40083 F4808 F48083	410101001 F48483LV			
490015022 F48483 F48483LV		5018-2017-001 F48483LV			1402-2139-001 ALL MODELS	490030103 ALL MODELS

CDF (500 SERIES)						
ELEMENT	MOTOR	RELAY	OUTLET GRILLE(2 REQ'D)	LOUVER GUIDES NAV W.	LOUVER GUIDES NOR W.	
						
302012802 542	302012813 552	3900-2011-000 542	5018-11006-000 542	2501-2020-001 NAVAJO WHITE	1215-2059-000 REA (2 REQ'D)	1215-2059-002 REA (2 REQ'D)
302012803 547	302012814 557	548	548	2501-2020-002 NORTHERN WHITE	1215-2059-001 SEA (2 REQ'D)	1215-2059-003 SEA (2 REQ'D)
302012801 548	302012812 558	552	552			
		3900-2011-001 547 557	5018-11006-001 547 557			
FAN DELAY	FAN BLADE	HI-LIMIT	POWER BLOCK			
						
1414-2039-000 ALL MODELS	1210-2000-000 ALL MODELS	4520-0011-000 ALL MODELS	5823-0004-000 MODELS NOT ENDING IN A	500T ALL MODELS		

\* MODELS ENDING IN (A) USE SAME PARTS BUT DO NOT HAVE POWER BLOCKS

**CU900 SERIES**



**ELEMENTS**

MODEL	NO. REQ	208V	NO. REQ	240V	NO. REQ	277V	NO. REQ	347V	NO. REQ	380V	NO. REQ	480V	NO. REQ	600V
<b>935</b>														
2KW	1	1802-2083-100	1	1802-2083-101	1	1802-2083-114	1	1802-2083-103	1	1802-2083-101	1	1802-2083-114	1	1802-2083-103
3KW	1	1802-2083-107	1	1802-2083-108	1	1802-2083-116	1	1802-2083-105	1	1802-2083-108	1	1802-2083-116	1	1802-2083-105
4KW	1	1802-2083-106	1	1802-2083-107	1	1802-2083-108	1	1802-2083-109	1	1802-2083-107	1	1802-2083-118	1	1802-2083-109
5KW	1	1802-2083-110	1	1802-2083-111	1	1802-2083-120	1	1802-2083-113	1	1802-2083-111	1	1802-2083-120	1	1802-2083-113
6KW	2	1802-2083-107	2	1802-2083-108	2	1802-2083-116	2	1802-2083-105	2	1802-2083-108	2	1802-2083-116	2	1802-2083-105
7KW	1	1802-2083-107	1	1802-2083-107	1	1802-2083-118	1	1802-2083-109	1	1802-2083-107	1	1802-2083-116	1	1802-2083-109
8KW	1	1802-2083-107	1	1802-2083-108	1	1802-2083-116	1	1802-2083-105	1	1802-2083-108	1	1802-2083-116	1	1802-2083-105
	1	1802-2083-110	1	1802-2083-111	1	1802-2083-120	1	1802-2083-113	1	1802-2083-111	1	1802-2083-120	1	1802-2083-113
<b>945</b>														
4KW	2	1802-2083-100	2	1802-2083-101	2	1802-2083-114	2	1802-2083-103	2	1802-2083-101	2	1802-2083-114	2	1802-2083-103
6KW	2	1802-2083-107	2	1802-2083-108	2	1802-2083-116	2	1802-2083-105	2	1802-2083-108	2	1802-2083-116	2	1802-2083-105
8KW	2	1802-2083-106	2	1802-2083-107	2	1802-2083-108	2	1802-2083-109	2	1802-2083-107	2	1802-2083-118	2	1802-2083-109
10KW	2	1802-2083-110	2	1802-2083-111	2	1802-2083-120	2	1802-2083-113	2	1802-2083-111	2	1802-2083-120	2	1802-2083-113
12KW	4	1802-2083-107	4	1802-2083-108	4	1802-2083-116	4	1802-2083-105	4	1802-2083-108	4	1802-2083-116	4	1802-2083-105
14KW	2	1802-2083-106	2	1802-2083-107	2	1802-2083-116	2	1802-2083-105	2	1802-2083-107	2	1802-2083-116	2	1802-2083-105
	2	1802-2083-107	2	1802-2083-108	2	1802-2083-118	2	1802-2083-109	2	1802-2083-108	2	1802-2083-118	2	1802-2083-109
16KW	2	1802-2083-107	2	1802-2083-108	2	1802-2083-116	2	1802-2083-105	2	1802-2083-108	2	1802-2083-116	2	1802-2083-105
	2	1802-2083-110	2	1802-2083-111	2	1802-2083-120	2	1802-2083-113	2	1802-2083-111	2	1802-2083-120	2	1802-2083-113

**58" AND LARGER HEATERS CONTACT FACTORY WITH CFID# ON UNIT'S NAMEPLATE**

**LOUVERED PANELS**

<b>DESERT TAN</b>	35"	4513-2114-T35	<b>NAVAJO WHITE</b>	35"	4513-2114-P35	<b>NORTHERN WHITE</b>	35"	4513-2114-W35	<b>STAT BRONZE</b>	35"	4513-2114-S35
	45"	4513-2114-T45		45"	4513-2114-P45		45"	4513-2114-W45		45"	4513-2114-S45
	58"	4513-2114-T58		58"	4513-2114-P58		58"	4513-2114-W58		58"	4513-2114-S58
	78"	4513-2114-T78		78"	4513-2114-P78		78"	4513-2114-W78		78"	4513-2114-S78
<b>ALUMINUM</b>	35"	4513-2114-A35	<b>BLACK</b>	35"	4513-2114-B35	<b>CHARCOL GREY</b>	35"	4513-2114-G35	<b>BEIGE</b>	35"	4513-2114-N35
	45"	4513-2114-A45		45"	4513-2114-B45		45"	4513-2114-N45			
	58"	4513-2114-A58		58"	4513-2114-B58		58"	4513-2114-N58			
			78"	4513-2114-B78	78"	4513-2114-N78					

**PANEL GRILLES NEW MODELS**







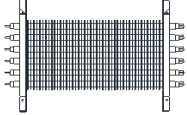
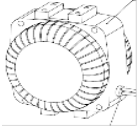

<b>NORTHERN WHITE</b>	35"	2501-11040-000W	<b>BEIGE</b>	35"	2501-11040-000N	<b>BLACK</b>	35"	2501-11040-000B	<b>ALUMINUM</b>	35"	2501-11040-000A
	45"	2501-11040-001W		45"	2501-11040-001N		45"	2501-11040-001B		45"	2501-11040-001A
	68"	2501-11040-003W		68"	2501-11040-003N		68"	2501-11040-003B		68"	2501-11040-003A
	78"	2501-11040-004W		78"	2501-11040-004N		78"	2501-11040-004B		78"	2501-11040-004A
<b>STAT BRONZE</b>	35"	2501-11040-000S									
	45"	2501-11040-001S									
	68"	2501-11040-003S									
	78"	2501-11040-004S									

CU900 CONTINUED							
PRIMARY TRANSFORMER		SEC. TRANSFORMER		MOTORS		BLOWER WHEEL	
CONTACT FACTORY WITH CFI# ON UNIT'S NAMEPLATE OR TRANSFORMER LABEL, PART NUMBERS ARE GENERALLY ON THE PART'S LABEL		490026910 MODELS WITH 24V CONTR.		2408/240V 3900-2032-000 277V 3900-2032-001 480V 3900-2032-002 SEE MOTOR LABEL SINGLE SHAFT	2408/240V 3900-2033-000 277V 3900-2033-001 480V 3900-2033-002 SEE MOTOR LABEL DOUBLE SHAFT	490047001 ALL MODELS	
DAMPER MOTOR	DAMPER RHEOSTAT	DAMPER RHEOSTAT KNOB	THERMOSTAT SPST	THERMOSTAT 2STG	THERMOSTAT KNOB	PLUG BUTTON	
3900-2023-000 MODELS WITH AIR DAMPER	410104001 MODELS WITH AIR DAMPER	482084001 MODELS WITH AIR DAMPER	410127001 SINGLE STAGE MODELS	5813-2008-000 TWO STAGE MODELS	3301-2020-001 ALL MODELS	4506-2012-000 ALL MODELS	
DAMPER ROCKER SW	FAN AUTO/ON SW	ON/OFF SW	HIGH/LOW SW	DOOR SAFETY SW	AUTO HIGH LIMIT	MANUAL LIMIT	
410131001 MODELS WITH AIR DAMPER	5216-2029-001 ALL MODELS	5216-2029-001 ALL MODELS	5216-2029-000 SINGLE STAGE MODELS	5216-2028-000 ALL MODELS	4520-2048-000 ALL MODELS	4520-2017-000 ALL MODELS	
FAN AUTO RELAY (120V)	FAN DELAY RELAY(120V)	POWER RELAY (120)	FAN AUTO RELAY (24V)	FAN DELAY RELAY (24V)	POWER RELAY (24)	NIGHT SETBACK RELAY	
410101003 MODELS WITH 120V CONTROL	410171002 MODELS WITH 120V CONTROL	410101003 MODELS WITH 120V CONTROL	410101001 MODELS WITH 24V CONTROL	410171001 MODELS WITH 24V CONTROL	410101001 MODELS WITH 24V CONTROL	410101001 MODELS WITH N.S. RELAY	
FUSE	FILTER		DISCONNECT SW				
481001017 ALL MODELS	2010-7008-006 CU935	2010-7009-006 CU935	30 AMP	5216-2033-000			
	2010-7008-007 CU945	2010-7009-007 CU945	60 AMP	5216-2033-001			
	2010-7008-008 CU958	2010-7009-008 CU958	100 AMP	5216-2033-002			
	2010-7008-009 CU968	2010-7009-009 CU968					
	2010-7008-010 CU978	2010-7009-010 CU978					

CU 900 SERIES STOCK MODELS						
ELEMENT		MOTOR				TIME DELAY RELAY
1802-2083-110 S93505203FFB S94510203FFB	1802-2083-120 S93505483FFB S94510483FFB	3900-2032-000 S93505203FFB S93505243FFB S93505483FFB S93505603FFB	3900-2033-000 S94510203FFB S94510243FFB S94510483FFB S94510603FFB	3900-2032-001 S93505271FFNC	3900-2033-001 S94510271FFNC	410101001 ALL MODELS
1802-2083-111 S93505243FFB S94510243FFB	S93505271FFNC S93505483FFNC S94510271FFNC			3900-2032-001 S93505483FFNC	3900-2033-002 S94510483FFNC	FAN DELAY RELAY 
1802-2083-121 S93505603FFB S94510603FFB	S94510483FFNC					410171001 ALL MODELS
PRI. TRANSFORMER	CAPACITOR		FILTER		FUSE	
490015025 S93505483FFB S94510483FFB	490015026 S93505603FFB S94510603FFB	1432-0002-003 S93505203FFB S93505243FFB S93505483FFB S93505603FFB S94510243FFB S94510483FFB S94510603FFB	1432-0002-001 S94510203FFB	2010-7008-006 S93505203FFB S93505243FFB S93505483FFB S93505603FFB	2010-7008-007 S94510203FFB S94510243FFB S94510483FFB S94510603FFB	481001017 ALL MODELS
490026002 S93505271FFNC S94510271FFNC	5814-0003-002 S93505483FFNC S94510483FFNC					PLUG BUTTON 
SEC. TR (240/24V)	MANUAL RESET	LIMIT	HIGH/LOW SW.	DOOR SW.	FAN AUTO/ON SW.	BLOWER WHEEL
490026910 ALL MODELS	4520-2017-000 ALL MODELS	4520-2048-000 ALL MODELS	5216-2029-000 ALL MODELS	5216-2028-000 ALL MODELS	5216-2029-001 ALL MODELS	490047001 ALL MODELS
THERMOSTAT	T'STAT KNOB					
410127001 ALL MODELS	3301-2020-001 ALL MODELS					



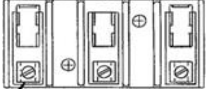



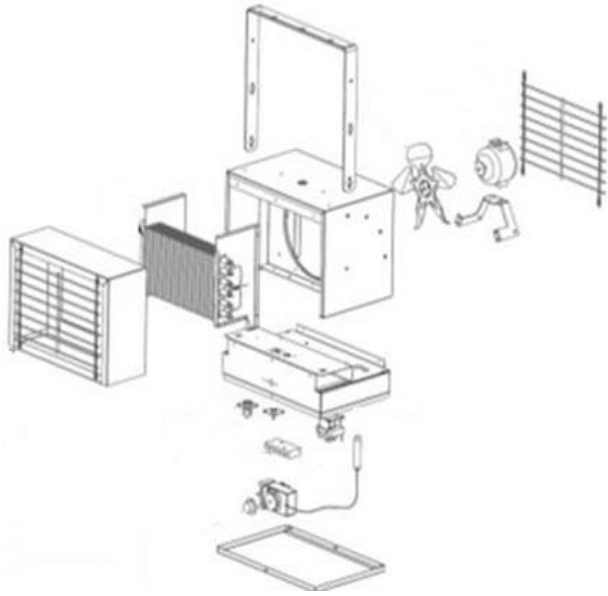





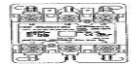





**COMPACT FREEZE PROTECTION HEATERS PHFP25**





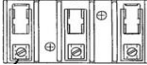







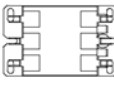
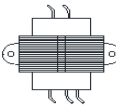

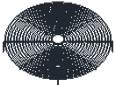

ELEMENT	MOTOR	FAN BLADE	FAN RELAY	RELAY
				
<b>1802-11002-000</b> CHPR25	<b>3900-11007-001</b> CHPR25	<b>1210-2017-000</b> CHPR25	<b>410171003</b> CHPR25	<b>1414-2038-000</b> CHPR25
THERMOSTAT	KNOB	HI LIMIT	POWER BLOCK	MT. BRACKET
				
<b>5813-2091-000</b> CHPR25	<b>3301-2053-000</b> CHPR25	<b>1414-2037-000</b> CHPR25	<b>5823-0004-005</b> CHPR25	<b>310876001</b> CHPR25

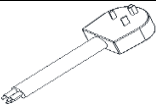

IUH SERIES

ELEMENT			FAN BLADE		MOTOR		RELAY		
									
302006804 UH520 UH520A	302006811 UH727 UH727A	302006842 UH1534 UH1560	1210-2017-000 UH520 UH520A UH524 UH524A	490011001 UH1020 UH1024 UH1027 UH1034 UH1048 UH1060 UH1520 UH1524 UH1527 UH1534 UH1548 UH1560A UH1560	3900-2008-000 UH520 UH520A UH524 UH524A UH534 UH534A UH538 UH538A UH548 UH548A UH560 UH560A UH720 UH720A UH724 UH724A UH748 UH748A	490059004 UH1020 UH1024 UH1027 UH1034 UH1048 UH1060 UH1520 UH1524 UH1527 UH1534 UH1548 UH1560 UH1560A UH720 UH720A UH724 UH724A UH748 UH748A	5018-0004-102 UH520A UH524A UH538 UH538A UH548 UH548A UH560 UH560A UH720 UH724 UH748 UH748A UH760 UH760A UH1034	5018-0003-002 UH534 UH534A UH734 UH734A UH1534	5018-0005-006 UH1020 UH1024 UH1027 UH1048 UH1060 UH1520 UH1524 UH1527 UH1548 UH1560 UH2034 UH2048 UH2060 UH2548 UH2560 UH3048 UH3060
302006807 UH524 UH524A UH548 UH548A	302006840 UH734 UH734A UH760 UH760A	302006829 UH2548 302006843 UH2560 302006822 UH3048 302006844 UH3060	UH534 UH534A UH538 UH538A UH548 UH548A UH560 UH560A UH720 UH720A UH724 UH724A UH727 UH727A UH734 UH734A UH748 UH748A UH760 UH760A	490011002 UH2034 UH2048 UH2060 490013001 UH2548 UH2560 490013002 UH3048 UH3060	3900-2008-001 UH727 UH727A	490059006 UH2548 UH2560 UH3048 UH3060	5018-0004-103 UH727 UH727A		
302006839 UH534 UH534A UH560 UH560A	302006812 UH1020 UH1527 302006813 UH1024 UH1048 UH1520 UH2048								
302006848 UH538 UH538A									
302006809 UH720 UH720A	302006814 UH1027 UH1524 UH1548								
302006810 UH724 UH724A UH748 UH748A	302006841 UH1034 UH1060 UH2034 UH2060								
LIGHT	FUSE BLOCK	FUSE	CAPACITOR	HI LIMIT	FAN DELAY	TRANSFORMER			
									
3510-2017-003 UH524A UH724A	480099002 UH1020 UH1024 UH1520 480099003 UH1520 UH1524 480096000 UH1527 480099001 UH1534 UH2034 2025-0001-000 UH2034	481001003 UH1020 UH1024 UH1520 UH1534 UH2034 481001006 UH1520 UH1524 481001023 UH1527 2019-7002-007 UH2034	1432-0002-003 UH2548 UH2560 UH3048 UH3060	410027000 ALL MODELS	410148000 ALL MODELS	490015017 UH534 UH534A UH734 UH734A 490015014 UH538 UH538A 490056001 UH548 UH548A UH748 UH748A	490015013 UH560 UH560A UH760 UH760A 490015009 UH1027 UH1527 490015019 UH1034 UH1534 UH2034	490015010 UH1048 UH1548 UH2048 490015012 UH1060 UH1560 UH2060 490015008 UH2548 UH3048 490015015 UH2560 UH3060	
QUANTITY 5 & 7.5KW (4) 10 THRU 20KW (6) 25 & 30KW (9)	LOUVER 	LOUVER SPRING 	HOLE PLUG 	MT. BRACKET 	POWER BLOCK 	THERMOSTAT (ASSEM INCLUDES KNOB) UHTA1 (ASSEMBLY 1-POLE) 410112000 THERMOSTAT 3301-2020-003 KNOB UHTA2 (ASSEMBLY 2-STAGE) 5813-2087-000 THERMOSTAT 3301-2053-000 KNOB			
3503-2004-109 UH520 UH520A UH524 UH524A UH534 UH534A UH538 UH538A UH548 UH548A UH560 UH560A UH720 UH720A UH724 UH724A UH727 UH727A UH734 UH734A UH748 UH748A UH760 UH760A	3503-2004-111 UH1020 UH1024 UH1027 UH1034 UH1048 UH1060 UH1520 UH1524 UH1527 UH1534 UH1548 UH1560 UH1560A UH2034 UH2048 UH2060	3503-2004-112 UH2548 UH2560 UH3048 UH3060	5208-7005-001 ALL MODELS	29214-11621 UH520 UH520A UH524 UH524A UH534 UH534A UH538 UH538A UH548 UH548A UH560 UH560A UH720 UH720A UH724 UH724A UH727 UH727A UH734 UH734A UH748 UH748A UH760 UH760A	310876001 UH520 UH520A UH524 UH524A UH534 UH534A UH538 UH538A UH548 UH548A UH560 UH560A UH720 UH720A UH724 UH724A UH727 UH727A UH734 UH734A UH748 UH748A UH760 UH760A	5823-0004-000 UH520 UH520A UH524 UH524A UH534 UH534A UH538 UH538A UH548 UH548A UH560 UH560A UH720 UH720A UH724 UH724A UH727 UH727A UH748 UH748A UH760 UH760A 5823-0004-005 UH734 UH734A	480100001 UH1020 UH1024 UH1027 UH1034 UH1048 UH1060 UH1520 UH1524 UH1527 UH1534 UH1548 UH1560 UH1560A UH2034 UH2048 UH2060 480034002 UH2548 UH2560 UH3048 UH3060		

## MEDH SERIES

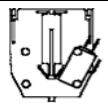
ELEMENT SMALL	ELEMENT LARGE	MOTOR	CONTACTOR		TRANSFORMER
					
<b>1802-11001-000</b> DH1583CKD <b>1802-11001-002</b> DH1021CKD DH1021D DH1521D DH1523D DH1543CKD DH3043D	<b>1802-11001-001</b> DH1583CKD <b>1802-11001-003</b> DH1021CKD DH1021D DH1521D DH1523D DH1543CKD DH3043D	<b>3900-11002-000</b> DH1583CKD DH1021CKD DH1021D DH1521D DH1523D <b>3900-11002-001</b> DH1543CKD DH3043D	<b>5018-0006-007</b> DH1583CKD DH1521D DH1523D	<b>5018-0006-009</b> DH1543CKD DH3043D <b>5018-0006-010</b> DH1021CKD	<b>5814-0003-002</b> DH1543CKD DH3043D
FAN BLADE	HI LIMIT	THERMOSTAT	CAPACITOR	GUARDS QTY.2 NEEDED	
					
<b>1210-0098-001</b> ALL MODELS	<b>410029000</b> ALL MODELS	<b>5813-2059-000</b> ALL MODELS	<b>1432-0002-003</b> ALL MODELS	<b>2504-11005-000</b> ALL MODELS	
HANDLE	CART KNOB	THERMOSTAT KNOB	WHEEL	SHAFT CAP	AXEL SHAFT
					
<b>2710-11001-000</b> ALL MODELS	<b>3301-11003-000</b> ALL MODELS	<b>3301-11018-002</b> ALL MODELS	<b>6406-0002-000</b> ALL MODELS	<b>1408-11002-000</b> ALL MODELS	<b>5217-11001-000</b> ALL MODELS
CORD	FUSE	FUSE BLOCK	FAN RELAY	FAN DELAY	AUXILIARY SWITCH
					
<b>SCS25064</b> DH1583CKD <b>SCS10063</b> DH1021CKD <b>SCS25124</b> DH1543CKD	<b>2019-7008-077</b> DH1521D	<b>480030007</b> DH1521D	<b>5018-0007-000</b> DH1543CKD DH3043D	<b>1414-2039-000</b> DH3043D	<b>5216-10564-000</b> DH1521D

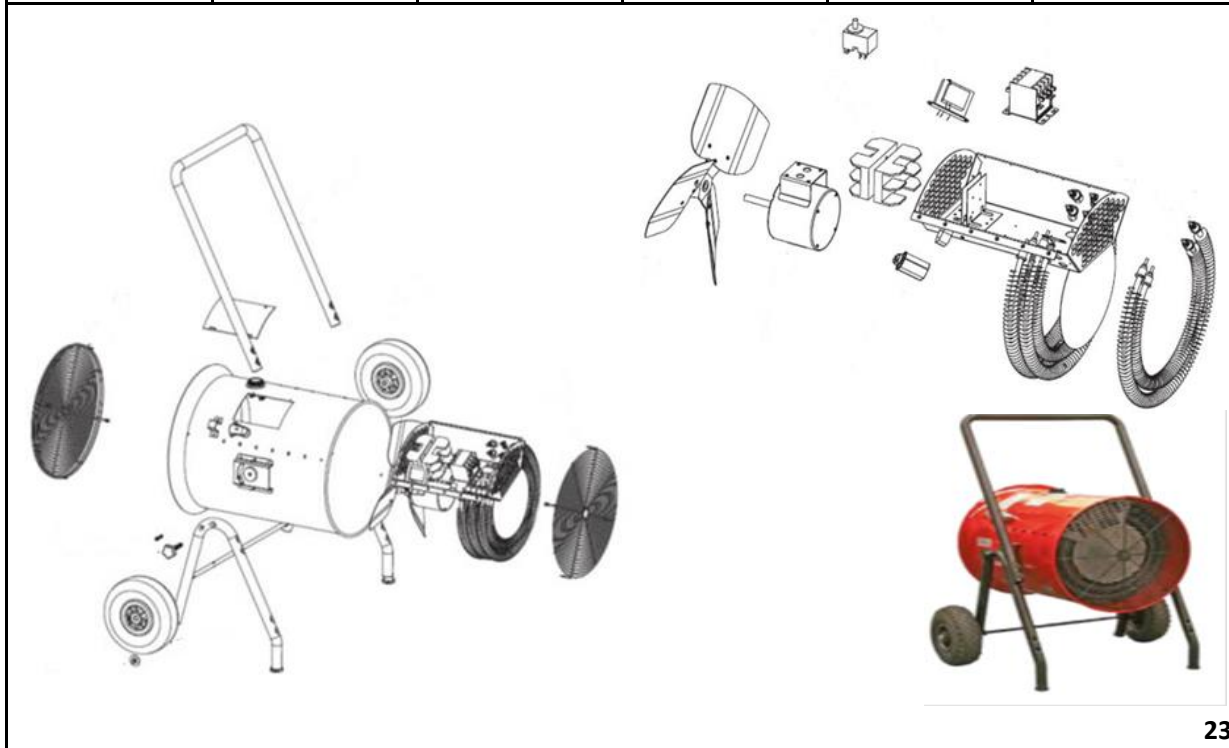



MSDH

MODEL	ELEMENT (11)	ELEMENT (12)	MOTOR (16)	CONTACTOR (20)
SDH3043	118-304793-011 (3)	118-304793-013 (3)	193-121843-232	072-304551-008
SDH3093	118-304793-012 (3)	118-304793-014 (3)	193-121843-233	072-304551-008
SDH4843	118-304793-011 (3)	118-304793-013 (6)	193-121843-232	072-304551-008 (2)
SDH4893	118-304793-012 (3)	118-304793-014 (6)	193-121843-233	072-304551-008 (2)
SDH6043	118-304793-011 (6)	118-304793-013 (6)	193-121843-232	072-304551-008 (2)
SDH6093	118-304793-012 (6)	118-304793-014 (6)	193-121843-233	072-304551-008 (2)
MODEL	TRANSFORMER (21)	FUSE BLOCK (80)	FUSE (81)	TERM. BLOCK (84)
SDH3043	315-304252-001	NA	NA	NA*
SDH3093	315-304252-003	NA	NA	NA*
SDH4843	315-304252-001	129-025643-001	128-026510-005 (3)	303-047468-004
SDH4893	315-304252-003	129-025643-001	128-026510-005 (3)	303-047468-004
SDH6043	315-304252-001	129-025643-001 (2)	128-026510-006 (6)	303-047468-004
SDH6093	315-304252-003	129-025643-001 (2)	128-026510-006 (6)	303-047468-004

PARTS COMMON TO ALL UNITS

TEMPERATURE CONTROL (18)	300-019560-002
HI-LIMIT (19)	300-049200-004
TOGGLE SWITCH (23)	292-046123-001
BLOWER ASSEMBLY (32)	021-304823-009
INLET & OUTLET GRILLE (33)	134-304780-002 (2)
CASTER/LOCKING (36)	375-122535-007
HANDLE-RIGHT SIDE (37)	139-304779-003
HANDLE-LEFT SIDE (38)	139-304479-004
SEMI-PNEUMATIC WHEEL (45)	333-557518-004 (2)
PULLEY VAR. PITCH 7/8" (77)	225-305091-004
PULLEY VAR. PITCH 5/8" (78)	225-305091-003
PULLEY BELT (79)	017-049702-009
PILOT LIGHT-GREEN (86)	213-122066-043
PILOT LIGHT-AMBER (87)	213-122066-042
THERMOSTAT KNOB (94)	169-017949-004

NOTES:  
 (#) QUANTITY REQ.  
 \* WIRED DIRECTLY TO CONTACTOR

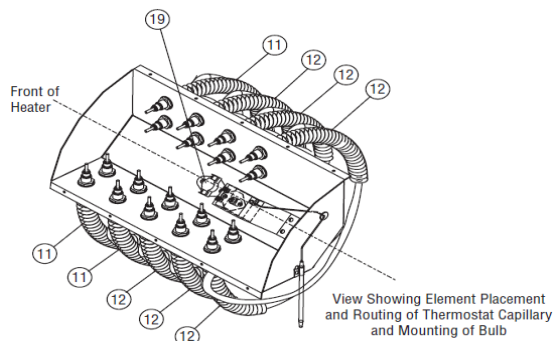
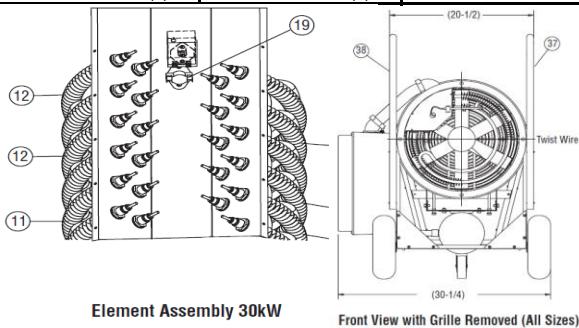

Element Assembly 48kW

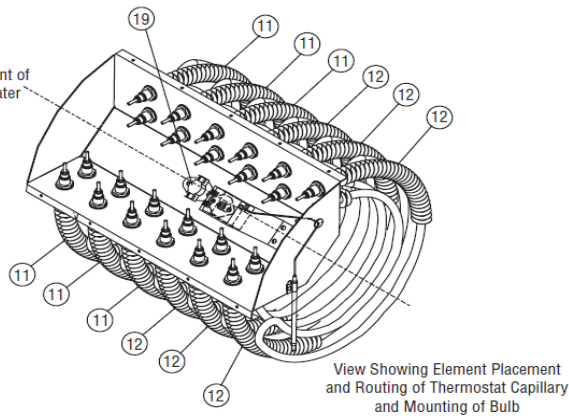

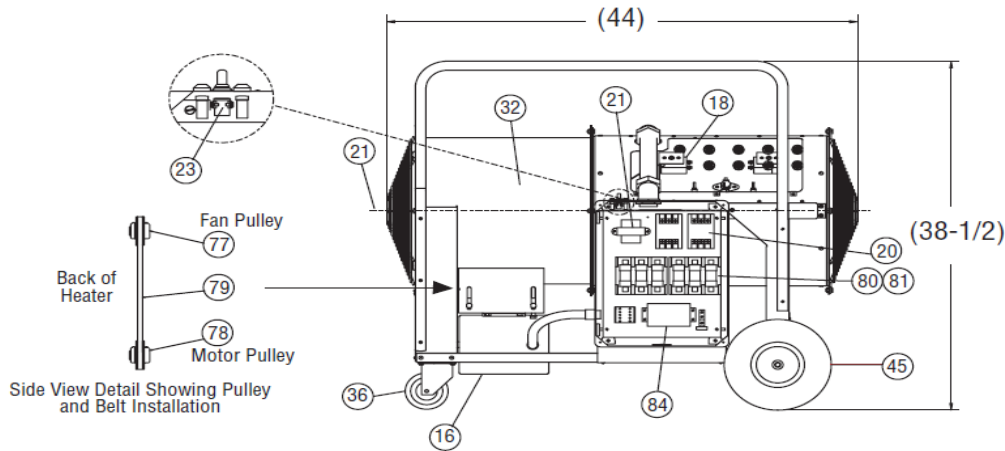

Element Assembly 60kW







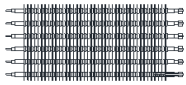
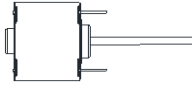





Side View shown with Heater and Control Terminal Box Covers Removed  
 All Sizes



**MSPH PLENUM RATED UNIT HEATER**







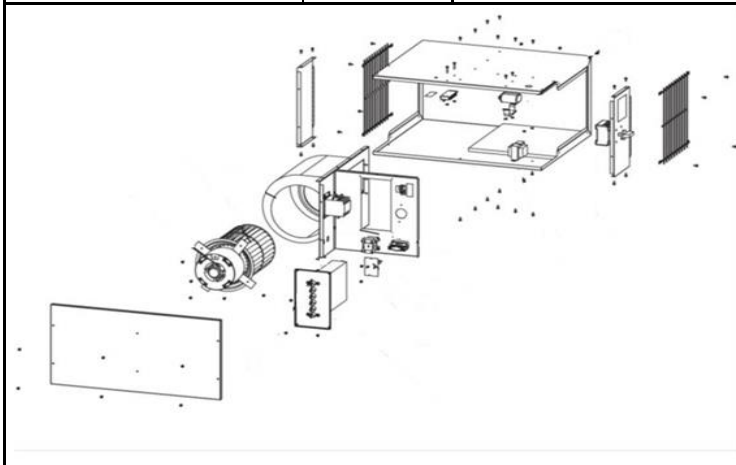



ELEMENT			MOTOR			CAPACITOR		
								
<b>1802-10498-000</b> PRH1381240000 PRH1383240000	<b>1802-10498-004</b> PRH11021240000 PRH11023240000 <b>1802-10498-001</b> PRH1521240000 PRH1521240000 PRH1523240000 <b>1802-10498-002</b> PRH1523240000 PRH1371240000 <b>1802-10498-003</b> PRH11083240000 PRH1581240000 PRH1581240000 PRH1583240000 PRH1583240000 PRH21083240000	<b>1802-10498-007</b> PRH1343240000 <b>1802-10498-008</b> PRH11583240000 PRH17581240000 PRH17583240000 <b>1802-10498-009</b> PRH11523240000 PRH17521240000 PRH17523240000 <b>1802-10498-010</b> PRH17571240000 <b>1802-10498-011</b> PRH11543240000 PRH17543240000 PRH21543240000 PRH21043240000	<b>3900-10164-001</b> PRH11043240000 PRH11543240000 PRH1343240000 PRH1543240000 PRH17543240000 PRH21043240000 PRH21543240000	<b>3900-10160-003</b> PRH11021240000 PRH11023240000 PRH1083240000 PRH11523240000 PRH1583240000 PRH1521240000 PRH1581240000 PRH1583240000 PRH1071240000 PRH17521240000 PRH17523240000 PRH17581240000 PRH17583240000 PRH21021240000 PRH21043240000 PRH21083240000 PRH21523240000	<b>3900-2094-001</b> PRH1321240000 PRH1323240000 PRH1381240000 PRH1383240000 PRH1521240000 PRH1523240000 PRH1581240000 PRH1583240000 <b>3900-2095-001</b> PRH171240000 PRH17521240000 PRH17523240000 PRH17581240000 PRH17583240000 PRH21021240000 PRH21043240000 PRH21083240000 PRH21523240000	<b>1432-0002-001</b> PRH11043240000 PRH11071240000 PRH11543240000 PRH1321240000 PRH1323240000 PRH1343240000 PRH1371240000 PRH1381240000 PRH1383240000 PRH1521240000 PRH1523240000	<b>1432-0002-002</b> PRH1543240000 PRH1571240000 PRH1571240000 PRH1581240000 PRH1583240000 PRH17543240000 PRH17571240000 PRH21043240000 PRH21071240000 PRH21543240000	PRH11021240000 PRH11023240000 PRH11083240000 PRH11523240000 PRH11583240000 PRH1321240000 PRH1323240000 PRH1343240000 PRH1371240000 PRH1381240000 PRH1383240000 PRH1521240000 PRH1523240000 PRH1543240000 PRH1571240000 PRH1581240000 PRH1583240000 PRH21021240000 PRH21023240000 PRH21043240000 PRH21071240000 PRH21083240000 PRH21523240000 PRH21543240000

BLOWER ASSEMBLY		LIMIT		GRILLE		
						
<b>1225-10158-000</b> PRH11021240000 PRH11023240000 PRH11043240000 PRH1071240000 PRH11083240000 PRH11523240000 PRH11543240000 PRH11583240000 PRH1521240000 PRH1523240000 PRH153240000 PRH1571240000 PRH1581240000 PRH1583240000	<b>1225-2022-000</b> PRH1321240000 PRH1323240000 PRH1343240000 PRH1371240000 PRH1381240000 PRH1383240000 PRH1521240000 PRH1523240000 PRH1543240000 PRH1571240000 PRH1581240000 PRH1583240000	<b>1414-2040-001</b> PRH11021240000 PRH11023240000 PRH11043240000 PRH1071240000 PRH11083240000 PRH11523240000 PRH11543240000 PRH11583240000 PRH1521240000 PRH1523240000 PRH153240000 PRH1571240000 PRH1581240000 PRH1583240000	<b>1414-2040-000</b> PRH1321240000 PRH1323240000 PRH1343240000 PRH1371240000 PRH1381240000 PRH1383240000 PRH1521240000 PRH1523240000 PRH1543240000 PRH1571240000 PRH1581240000 PRH1583240000	<b>2501-10156-800</b> PRH11021240000 PRH11023240000 PRH11043240000 PRH1071240000 PRH11083240000 PRH11523240000 PRH11543240000 PRH11583240000 PRH1521240000 PRH1523240000 PRH153240000 PRH1571240000 PRH1581240000 PRH1583240000	<b>312056803</b> PRH1321240000 PRH1323240000 PRH1343240000 PRH1371240000 PRH1381240000 PRH1383240000 PRH1521240000 PRH1523240000 PRH1543240000 PRH1571240000 PRH1581240000 PRH1583240000	

TRANSFORMER		TERMINAL BLOCK		TIME DELAY RELAY	FAN RELAY	DISCONNECT SW.
						
<b>5814-0003-000</b> PRH11021240000 PRH11023240000 PRH11083240000 PRH11523240000 PRH11583240000 PRH1321240000 PRH1323240000 PRH1381240000 PRH1383240000 PRH1521240000 PRH1523240000 PRH153240000	<b>5814-0003-001</b> PRH11071240000 PRH1171240000 PRH1571240000 PRH17571240000 PRH21071240000 <b>5814-0003-002</b> PRH11043240000 PRH11543240000 PRH1343240000 PRH1343240000 PRH1543240000 PRH17543240000 PRH21043240000 PRH21543240000	<b>480106001</b> PRH11021240000 PRH11023240000 PRH11043240000 PRH1071240000 PRH11083240000 PRH11523240000 PRH11543240000 PRH11583240000 PRH1321240000 PRH1323240000 PRH1343240000 PRH1371240000 PRH1381240000 PRH1383240000 PRH1521240000 PRH1523240000	<b>480106002</b> PRH1523240000 PRH1523240000 PRH1543240000 PRH1543240000 PRH1571240000 PRH1571240000 PRH1581240000 PRH1581240000 PRH1583240000 PRH1583240000 PRH17521240000 PRH17521240000 PRH17523240000 PRH17523240000 PRH17543240000 PRH17571240000 PRH17581240000 PRH17583240000	<b>410171001</b> ALL MODELS <b>CONTACTOR RELAY</b>  <b>5018-0005-004</b> ALL MODELS	<b>5018-2024-000</b> ALL MODELS 	<b>5216-2036-000</b> ALL MODELS





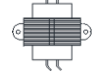
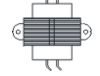



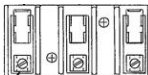

**MUH SERIES**

ELEMENT				MOTOR			CAPACITOR
QUANTITY OF ELEMENTS 3 THRU 10KW (3) 15 THRU 30KW (6) 40 & 50KW (9)							
1802-0087-000 MUH0321	1802-0087-004 MUH0571	1802-0087-011 MUH104	1802-0087-046 MUH256	3900-2002-506 MUH0321	3900-2014-004 MUH072	3900-0364-000 MUH252	1432-0002-003 MUH202
1802-0087-040 MUH0331	1802-0087-034 MUH0581	1802-0087-010 MUH107	1802-0087-018 MUH302	MUH0381	MUH073	MUH256	MUH204
1802-0087-002 MUH0341	1802-0087-025 MUH0581MG	1802-0087-036 MUH108	1802-0087-019 MUH304	MUH0521MG	MUH076	MUH302	MUH206
1802-0087-000 MUH0361	1802-0087-006 MUH072	1802-0087-012 MUH152	1802-0087-047 MUH306	MUH0581	MUH077	MUH306	MUH208
1802-0087-001 MUH0371	1802-0087-042 MUH073	1802-0087-008 MUH154	1802-0087-028 MUH308	MUH0581MG	MUH078	MUH308	MUH252
1802-0087-024 MUH0381	1802-0087-008 MUH074	1802-0087-002 MUH156	1802-0087-020 MUH402	MUH0561	MUH102	3900-0363-500 MUH254	MUH254
1802-0087-035 MUH0521	1802-2073-002 MUH076	1802-0087-037 MUH158	1802-0087-021 MUH404	3900-2005-000 MUH0341	3900-0361-501 MUH154	3900-0350-000 MUH402	1432-11004-000 MUH254A
1802-0087-003 MUH0521MG	1802-0087-007 MUH077	1802-0087-026 MUH202	1802-0087-048 MUH406	MUH0541	3900-0361-003 MUH156	MUH502	MUH304A
1802-0087-041 MUH0531	1802-0087-031 MUH078	1802-0087-016 MUH208	1802-0087-022 MUH502	3900-2002-507 MUH0371	3900-0362-000 MUH202	MUH506	1432-0002-001 MUH308
1802-0087-005 MUH0541	MUH102	1802-0087-017 MUH252	1802-0087-023 MUH504	MUH0571	3900-0362-001 MUH206	3900-0350-001 MUH404	1432-0002-004 MUH402
1802-2073-001 MUH0561	1802-0087-044 MUH103 MUH106 MUH206	MUH254 MUH254A	1802-0087-049 MUH506	MUH074 MUH104	3900-0362-001 MUH204	MUH406 MUH504	MUH502
1802-0087-030 MUH508			1802-0087-030 MUH508	3900-0361-500 MUH152 MUH158	3900-0362-002 MUH208	3900-0350-000 MUH508	MUH508
PROTECTOR LIMIT				FAN DELAY	FAN BLADE		HI/LOW SP. SWITCH
							
4520-0011-000 MUH0321 MUH0331 MUH0341 MUH0361 MUH0371 MUH0381 MUH0521 MUH0521MG MUH0531 MUH0541 MUH0561 MUH0571 MUH0581 MUH0581MG	4520-0011-001 MUH072 MUH073 MUH074 MUH076 MUH077 MUH078 MUH102 MUH103 MUH104 MUH106 MUH107 MUH108 MUH152 MUH154 MUH156 MUH158 MUH202 MUH204 MUH206 MUH208	4520-0011-002 MUH252 MUH254 MUH254A MUH256 MUH302 MUH304 MUH304A MUH306 MUH308 MUH402 MUH404 MUH406 MUH502 MUH504 MUH506 MUH508	4520-0010-000 ALL MODELS	1210-2000-000 MUH0321 MUH0331 MUH0341 MUH0361 MUH0371 MUH0381 MUH0521 MUH0521MG MUH0531 MUH0541 MUH0561 MUH0571 MUH0581 MUH0581MG	1210-0090-000 MUH072 MUH073 MUH074 MUH076 MUH077 MUH078 MUH102 MUH103 MUH104 MUH106 MUH107 MUH108	1210-0098-000 MUH252 MUH254 MUH254A MUH256 MUH302 MUH304 MUH304A MUH306 MUH308	5216-2053-000 MUH252 MUH254 MUH254A MUH256 MUH302 MUH304 MUH304A MUH306 MUH308 MUH402 MUH404 MUH406 MUH502 MUH504 MUH506 MUH508
1210-0090-001 MUH152 MUH154 MUH156 MUH158	1210-0096-000 MUH202 MUH204 MUH206 MUH208	1210-11004-000 MUH402 MUH404 MUH406 MUH502 MUH504 MUH506 MUH508					
RELAY				POWER TR			SECONDARY TR
							
30 AMP 5018-0003-000 MUH0331 MUH0531 MUH073 MUH077 MUH103 MUH107	35 AMP 5018-0004-100 MUH0341 MUH0361 MUH0541 MUH0561 MUH074 MUH076 MUH104 MUH106 MUH154 MUH206 MUH256 MUH306 MUH506	40 AMP 5018-0005-004 MUH072 MUH078 MUH102 MUH108 MUH152 MUH158 MUH204 MUH208 MUH252 MUH254 MUH254A MUH302 MUH304 MUH304A MUH402 MUH404 MUH406 MUH502 MUH506	50 AMP 5018-0006-000 MUH202 MUH308 MUH504 MUH508	240/208V PR TO 24V SEC 5814-0003-000 MUH072 MUH078 MUH102 MUH103 MUH108 MUH152 MUH158 MUH202 MUH208 MUH252 MUH302 MUH308	480V PR TO 24V SEC 5814-0003-002 MUH0341 MUH0541 MUH074 MUH104 MUH154 MUH204 MUH254 MUH254A MUH304 MUH304A MUH404 MUH504	600V PR TO 240V SEC 490015013 MUH0361 MUH0561 600V PR TO 240V SEC 490015015 MUH406 MUH502 MUH506 347V PR TO 240V SEC 490015017 MUH0331 MUH0531 347V PR TO 240V SEC 490015018 MUH073 MUH103 600V PR TO 240V SEC 490015021 MUH076	240/208V PR TO 24V SEC 5814-0003-000 MUH0331 MUH0361 MUH0531 MUH0561 MUH073 MUH103 MUH106 MUH156 MUH206 MUH256 MUH306 MUH406 MUH506
30 AMP 5018-0003-002 MUH0521MG MUH0581MG	40 AMP 5018-10562-004 MUH402 MUH502 MUH508	277V PR TO 24V SEC 5814-0003-001 MUH077 MUH107	240V/208V PR TO 24V SEC 490026007 MUH402 MUH502 MUH508	600V PR TO 240V SEC 490015012 MUH106 MUH156 MUH206 MUH256 MUH306			

PRO AND PRO-SSP CONTINUE NEXT PAGE









MUH CONTINUED





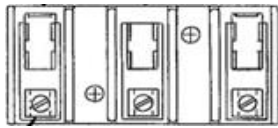
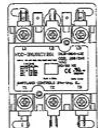
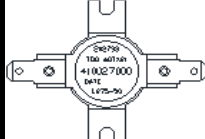
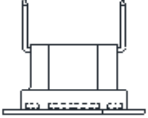

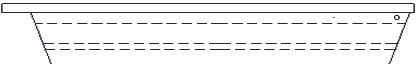



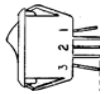

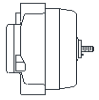

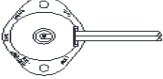

CONTROL BOARD		POWER BLOCK	
			
5823-0001-000	5823-0002-000	5823-0004-000	5823-0004-001
MUH0321 MUH0371 MUH0381 MUH0521 MUH0571 MUH0581	MUH202 MUH204 MUH206 MUH208 MUH252 MUH254 MUH254A MUH256 MUH302 MUH304 MUH304A MUH306 MUH308 MUH402 MUH404 MUH406 MUH104 MUH106 MUH107 MUH108 MUH152 MUH154 MUH156 MUH158	MUH0381-PRO MUH0321-PRO MUH0341-PRO MUH0581-PRO MUH0521-PRO MUH0541-PRO MUH078-PRO MUH074-PRO MUH108-PRO MUH102-PRO MUH104-PRO MUH0381-PRO-SSP MUH0321-PRO-SSP MUH0341-PRO-SSP MUH0581-PRO-SSP MUH0521-PRO-SSP MUH0541-PRO-SSP MUH078-PRO-SSP MUH072-PRO-SSP MUH074-PRO-SSP MUH108-PRO-SSP MUH102-PRO-SSP MUH104-PRO-SSP	MUH0321 MUH0331 MUH0341 MUH0361 MUH0371 MUH0381 MUH0521 MUH0521MG MUH0531 MUH0541 MUH0561 MUH074 MUH076 MUH077 MUH078 MUH102 MUH103 MUH104 MUH106 MUH107 MUH108 MUH154 MUH156 MUH204 MUH206 MUH256 MUH306

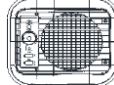







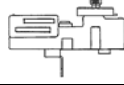

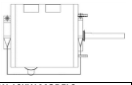
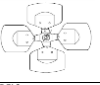



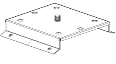

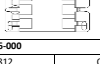
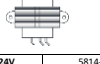
QUANTITY	LOUVERS	LOUVER SPRING	FUSE BLOCK	FUSE	THERMOSTAT (ASSM INCLUDES KNOB)
38.5KW (5) 7 THRU 20KW (6) 25 THRU 50KW (9)					UHM1T (ASSEMBLY 1-POLE) 5813-0036-000 THERMOSTAT 3301-2020-006 KNOB UHM2T (ASSEMBLY 2-STAGE) 5813-0037-000 THERMOSTAT 3301-2020-006 KNOB
3503-2004-106	3503-2004-107	3503-2004-108	5208-7005-001	2025-0002-000 2019-0007-010 480030004 2019-0007-008 2019-7008-077 2019-7008-079 2025-0001-000 2025-7004-000	2019-0007-010 2019-0007-008 2019-7008-077 2019-7008-079 2019-7008-080 2019-7008-078 2019-7002-008 2019-7002-007 2019-7002-012 2019-7002-011
MUH0321 MUH0331 MUH0341 MUH0361 MUH0371 MUH0381 MUH0521 MUH0521MG MUH0531 MUH0541 MUH0561 MUH0571 MUH0581 MUH0581MG	MUH072 MUH073 MUH074 MUH076 MUH077 MUH078 MUH102 MUH103 MUH104 MUH106 MUH107 MUH108 MUH152 MUH154 MUH156 MUH158 MUH202 MUH204 MUH206 MUH208	MUH252 MUH254 MUH254A MUH256 MUH302 MUH304 MUH304A MUH306 MUH308 MUH402 MUH404 MUH406 MUH502 MUH504 MUH506 MUH508	ALL MODELS	MUH158 MUH208 MUH252 MUH302 MUH308 MUH502 MUH508 MUH504 MUH506 MUH504 MUH506	MUH158 MUH202 MUH208 MUH252 MUH306 MUH308 MUH502 MUH508 MUH308 MUH508 MUH402 MUH504 MUH506 MUH506 MUH504 MUH506

MUH PRO SERIES				
SAME PARTS AS STOCK MODELS WITH ADDED DISCONNECT SWITCH, THERMOSTAT, & 24V CONTROL CIRCUIT				
MODEL	DISCONNECT SWITCH	THERMOSTAT	TRANSFORMER	RELAY
MUH0381-PRO	5216-2036-000	UHMT1	5814-0003-000	5018-0003-000
MUH0321-PRO	5216-2036-000	UHMT1	5814-0003-000	5018-0003-000
MUH0341-PRO	5216-2036-000	UHMT1	5814-0003-002	5018-0004-100
MUH0581-PRO	5216-2036-000	UHMT1	5814-0003-000	5018-0003-000
MUH0521-PRO	5216-2036-000	UHMT1	5814-0003-000	5018-0003-000
MUH0541-PRO	5216-2036-000	UHMT1	5814-0003-002	5018-0004-100
MUH078-PRO	5216-2039-000	UHMT1	5814-0003-000	5018-0003-000
MUH072-PRO	5216-2039-000	UHMT1	5814-0003-000	5018-0003-000
MUH074-PRO	5216-2036-000	UHMT1	5814-0003-002	5018-0004-100
MUH108-PRO	5216-2039-000	UHMT1	5814-0003-000	5018-0004-100
MUH102-PRO	5216-2039-000	UHMT1	5814-0003-000	5018-0003-000
MUH104-PRO	5216-2036-000	UHMT1	5814-0003-002	5018-0004-100
MODEL	DISCONNECT SWITCH	THERMOSTAT	TRANSFORMER	RELAY
MUH0381-PRO-SSP	5216-2036-000	1414-11050-000	5814-0003-000	5018-0003-000
MUH0321-PRO-SSP	5216-2036-000	1414-11050-000	5814-0003-000	5018-0003-000
MUH0341-PRO-SSP	5216-2036-000	1414-11050-000	5814-0003-002	5018-0004-100
MUH0581-PRO-SSP	5216-2036-000	1414-11050-000	5814-0003-000	5018-0003-000
MUH0521-PRO-SSP	5216-2036-000	1414-11050-000	5814-0003-000	5018-0003-000
MUH0541-PRO-SSP	5216-2036-000	1414-11050-000	5814-0003-002	5018-0004-100
MUH078-PRO-SSP	5216-2039-000	1414-11050-000	5814-0003-000	5018-0003-000
MUH072-PRO-SSP	5216-2039-000	1414-11050-000	5814-0003-000	5018-0003-000
MUH074-PRO-SSP	5216-2036-000	1414-11050-000	5814-0003-002	5018-0004-100
MUH108-PRO-SSP	5216-2039-000	1414-11050-000	5814-0003-000	5018-0004-100
MUH102-PRO-SSP	5216-2039-000	1414-11050-000	5814-0003-000	5018-0003-000
MUH104-PRO-SSP	5216-2036-000	1414-11050-000	5814-0003-002	5018-0004-100

## MWUH SERIES







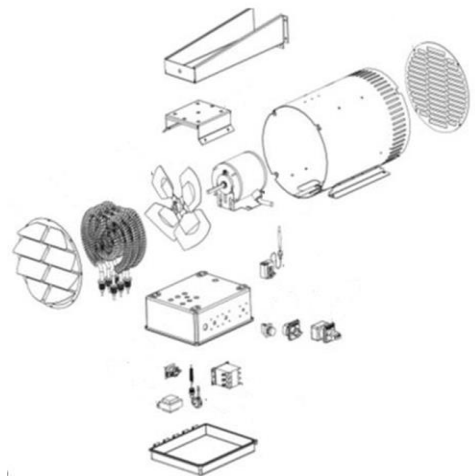

ELEMENT		MOTOR	FAN BLADE	KNOB	THERMOSTAT
					
<b>302006807</b> MWUH5004 MWUH5004A	<b>302006847</b> MWUH5008 MWUH5008A	<b>3900-2008-000</b> MWUH5004 MWUH5004A MWUH5008 MWUH5008A UH724ST UH724STA	<b>1210-2017-000</b> MWUH5004 MWUH5004A MWUH5008 MWUH5008A UH724ST UH724STA	<b>3301-2014-006</b> MWUH5004 MWUH5004A MWUH5008 MWUH5008A UH724ST UH724STA	<b>5813-2050-000</b> MWUH5004 MWUH5004A MWUH5008 MWUH5008A UH724ST UH724STA
POWER BLOCK		RELAY	HI LIMIT	FAN DELAY	LIGHT
					
<b>5823-0004-005</b> MWUH5004 MWUH5004A MWUH5008 MWUH5008A	<b>5823-0004-000</b> UH724ST UH724STA	<b>5018-11006-000</b> UH724ST UH724STA	<b>410027000</b> MWUH5004 MWUH5004A MWUH5008 MWUH5008A UH724ST UH724STA	<b>410148000</b> MWUH5004 MWUH5004A MWUH5008 MWUH5008A UH724ST UH724STA	<b>3510-2017-003</b> MWUH5004A UH724STA
LOUVERS		LOUVER SPRING	MT. BRACKET		
					
<b>3503-2004-109</b> MWUH5004 MWUH5004A MWUH5008 MWUH5008A UH724ST UH724STA		<b>5208-7005-001</b> MWUH5004 MWUH5004A MWUH5008 MWUH5008A UH724ST UH724STA	<b>310876001</b> MWUH5004 MWUH5004A MWUH5008 MWUH5008A UH724ST UH724STA		

QPH4A & MUH35 SERIES					
ROCKER SWITCH**	FAN BLADE		ELEMENT***		MOTOR
					
<b>S99814893A000</b> MUH35 MUH35B MUH35C MUH35D PH4A PH4AB NPH4AB NPH4ABA	<b>1210-2000-000</b> MUH35 MUH35B MUH35C MUH35D PH4 PH4A	<b>1210-2000-001</b> PH4AB NPH4AB NPH4ABA	<b>1802-0087-032</b> MUH35 MUH35B MUH35C MUH35D	<b>1802-0087-038</b> PH4 PH4A PH4AB NPH4AB NPH4ABA	<b>3900-2002-506</b> MUH35 MUH35B MUH35C MUH35D PH4 PH4A PH4AB NPH4AB NPH4ABA
FAN DELAY	MANUAL RESET			LIMIT	BUZZER
					
<b>4520-0010-000</b> MUH35C MUH35D	<b>4520-2017-000</b> MUH35B MUH35C PH4A	<b>4520-11004-000</b> PH4AB NPH4AB	<b>4520-11004-002</b> MUH35D NPH4ABA	<b>4520-0011-000</b> MUH35 PH4	<b>2714-11001-000</b> MUH35D
STAND	CONTROL COVER	GRILLE	GUARD	T'STAT KNOB	STAND KNOB**
					
<b>5210-2000-002</b> MUH35B MUH35C MUH35D PH4A PH4AB NPH4AB NPH4ABA	<b>1402-0336-000</b> MUH35 MUH35B MUH35C MUH35D PH4 PH4AB NPH4AB NPH4ABA	<b>1402-2154-001</b> MUH35B MUH35C MUH35D PH4AB NPH4AB NPH4ABA	<b>2504-0011-001</b> MUH35B MUH35C MUH35D PH4 PH4AB NPH4AB NPH4ABA	<b>3301-2012-001</b> MUH35B MUH35C MUH35D PH4AB NPH4AB NPH4ABA	<b>3301-2018-000</b> MUH35 MUH35B MUH35C MUH35D PH4AB NPH4AB NPH4ABA
LIGHT	CORD	THERMOSTAT			
					
<b>3510-2007-000</b> MUH35B MUH35C MUH35D	<b>1420-2028-000</b> PH4AB <b>1420-11012-000</b> NPH4AB NPH4ABA	<b>5813-2018-000</b> MUH35 MUH35B MUH35C MUH35D PH4A PH4AB NPH4AB NPH4ABA	<b>5813-0047-000</b> PH4		
NOTE * INDICATES QUANTITY					

WD SERIES WASHDOWN UNIT HEATER														
MOTOR			BLADE			ELEMENT								
 208-240/480V 2KW-10KW MODELS 277V 3KW-10KW MODELS 120V 2-3KW MODELS 208-240/480V 12.5KW-39KW MODELS			 10KW MODELS 12KW MODELS WITH EPOXY COATING 2-7.5KW MODELS 2-7.5KW MODELS WITH EPOXY COATING 12.5KW MODELS 12.5KW MODELS WITH EPOXY COATING 15-39KW MODELS WITH EPOXY COATING			 QUANTITY REQ 2KW (2) 3 THRU 15KW (3) 20 THRU 39KW (6)								
2-10KW 12.5-39KW 4520-11013-000 4520-11013-001			 3900-11036-000 3900-11036-001 3900-11036-002 3900-11037-000			1210-11007-000 1210-11007-002 1210-11007-001 1210-11007-003 1210-11008-000 1210-11008-001 1210-11008-002 1210-11008-003		1802-11012-001 1802-11012-002 1802-11012-003 1802-11012-004 1802-11012-005 1802-11012-006 1802-11012-007 1802-11012-008 1802-11012-011 1802-11012-012 1802-11012-009 1802-11012-008		10KW 208V 10KW 240V 10KW 277V 10KW 480V 12.5KW 208V 12.5KW 240V 15KW 208V 15KW 240V 20KW 240V 25KW 208V 30KW 240V 15 & 30KW 480V 20KW 480V 39KW 480V				
 WALL/CEILING BRK 2-10KW MODELS 12.5-39KW MODELS			 NAT BRACKET 2-10KW MODELS 12.5-39KW MODELS			1016-11218-000 1016-11218-001		5KW 480V 3PH 5KW 480V 1PH 7.5KW 208V 7.5KW 240V 7.5KW 277V 7.5KW 480V		1802-11012-008 1802-11012-008 1802-11012-011 1802-11012-012 1802-11012-009 1802-11012-008				
FAN RELAY					CONTACTOR 50A					TRANSFORMER				
 5018-11005-000					 5018-0006-000					 5018-0006-001				
QW02112 QW05712 QW02812 QW03112 QW03212 QW03232 QW03432 QW03712 QW03812 QW03832 QW05212 QW05232 QW05412 QW05432 QW05712 QW05812 QW05832 QW07212 QW07232 QW07412 QW07432 QW07712					QW025232 QW025432 QW025832 QW030232 QW030432 QW030832 QW03432 QW03712 QW03812 QW03832 QW05212 QW05232 QW05412 QW05432 QW05712 QW05812 QW05832 QW07212 QW07232 QW07412 QW07432 QW07712					QW025232 QW025432 QW025832 QW030232 QW030432 QW030832 QW03432 QW03712 QW03812 QW03832 QW05212 QW05232 QW05412 QW05432 QW05712 QW05812 QW05832 QW07212 QW07232 QW07412 QW07432 QW07712				
2504-11018-000 2504-11020-000					2504-11019-001 2504-11021-001					208/240V TO 24V 277V TO 24V 208/240V TO 120V 277V TO 120V 480V TO 120V				
 GRILLE INLET 2-10KW MODELS 12.5-39KW MODELS					 GRILLE OUTLET 2-10KW MODELS 12.5-39KW MODELS					 STRAIGHT FITTING 1213-2009-000 ALL MODELS				
 CAPACITOR					 POWER BLOCK					 SILICONE SEAL PICTURE NOT AVAILABLE 5250-2001-000 ALL MODELS				
 TERMINAL BLOCK					 TERMINAL BLOCK					 TERMINAL BLOCK				
1432-0002-001					1432-0002-002					1432-0002-004				
QW02112 QW02212 QW02812 QW03112 QW03212 QW03232 QW03432 QW03812 QW03832 QW05212 QW05412 QW05432					QW02212 QW02812 QW03112 QW03212 QW03232 QW03432 QW03812 QW03832 QW05212 QW05412 QW05432					QW02212 QW02812 QW03112 QW03212 QW03232 QW03432 QW03812 QW03832 QW05212 QW05412 QW05432				
5823-0004-002					480024002					5823-2006-000 ALL MODELS				
QW02112 QW02212 QW02812 QW03112 QW03212 QW03232 QW03432 QW03812 QW03832 QW05212 QW05412 QW05432					QW02112 QW02212 QW02812 QW03112 QW03212 QW03232 QW03432 QW03812 QW03832 QW05212 QW05412 QW05432					QW02112 QW02212 QW02812 QW03112 QW03212 QW03232 QW03432 QW03812 QW03832 QW05212 QW05412 QW05432				
PART					GASKET					KNOB				
THERMOSTAT					PILOT LIGHT					MODE SWITCH				
DISCONNECT SWITCH					MANUAL RESET					EPOXY COATING				

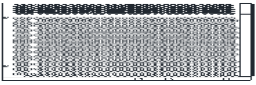
Factory Installed Accessories	
CATALOG NUMBER	DESCRIPTION
T	Thermostat
L	Pilot Light
S	Mode/Selector Switch
D	Disconnect Switch
E	Monel Element*
M	Manual Reset
P	Epoxy Coating



KCI															
ELEMENT				LINEAR LIMIT			TR. RELAY								
															
1802-11021-003 J400B	1802-2044-011 J750B	1802-2044-014 J1007B	1802-2044-228 J1503B	4520-2018-000 J400B	4520-2018-003 J1000B	4520-2018-005 J1500B	5018-11003-003 J503B	410043007 J1006B							
1802-11021-001 J404B	1802-2044-210 J753B	1802-2044-016 J1008B	1802-2044-027 J1504B	J404B	J1003B	J1503B	J753B	J1256B							
1802-11021-000 J407B	1802-2044-009 J754B	1802-2044-023 J1250B	1802-2044-229 J1506B	J407B	J1004B	J1504B	J1003B	J1506B							
1802-11021-002 J408B	1802-2044-008 J757B	1802-2044-222 J1253B	1802-2044-026 J1507B	4520-2018-001 J500B	J1006B	J1506B	J1253B	J2006B							
1802-2044-043 J500B	1802-2044-010 J758B	1802-2044-021 J1254B	1802-2044-028 J1508B	J503B	J1007B	J1507B	J1503B	J2003B							
1802-2044-202 J503B	1802-2044-017 J1000B	1802-2044-223 J1256B	1802-2044-234 J2003B	J504B	4520-2018-004 J1250B	4520-2018-006 J2003B	J1253B	J2004B							
1802-2044-041 J504B	1802-2044-216 J1003B	1802-2044-020 J1257B	1802-2044-033 J2004B	J507B	J1254B	J2006B	J1253B	J2007B							
1802-2044-040 J507B	1802-2044-015 J1004B	1802-2044-022 J1258B	1802-2044-235 J2006B	4520-2018-002 J750B	J1256B	J2007B	J2008B	J2008B							
1802-2044-042 J508B	1802-2044-217 J1006B	1802-2044-029 J1500B	1802-2044-032 J2007B	J753B	J1257B	J2008B									
			1802-2044-034 J2008B	J754B	J1258B										
				J757B											
				J758B											
SWITCH		FRONT COVER				CONTROL COVER	THERMOSTAT								
															
5216-11007-000 J400B J404B J407B J408B J500B J504B J507B J508B J750B J754B J757B J758B J1000B J1004B		5216-2053-000 J503B J1008B J1003B J1006B J1253B J1258B J1500B J1503B J1504B J1506B J2003B J2006B		1402-2192-006 J400B J404B J407B J408B 1402-2192-001 J500B J503B J504B J507B J508B 1402-2192-002 J750B J753B J754B J757B J758B		1402-2192-003 J1000B J1003B J1004B J1006B J1007B J1008B 1402-2192-004 J1250B J1253B J1254B J1256B J1257B J1258B		1402-2192-005 J1500B J1503B J1504B J1506B J1507B J1508B 1402-2192-007 J2003B J2004B J2006B J2007B J2008B		1402-11020-000 ALL MODELS			5813-0024-000 ALL MODELS		
															

**SHA & DBA SERIES**

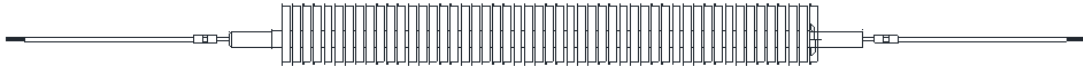

DISCRIPTION	PART NUMBERS					
	120V	208V	240V	277V	347V	600V
<b>*ELEMENT (100 WATTS/FT)</b>						
<b>28" HEATER</b>	1802-2001-047	1802-2001-048	1802-2001-049	NA	NA	NA
3'	1802-2001-053	1802-2001-054	1802-2001-055	1802-2001-056	NA	NA
4'	1802-2001-059	1802-2001-060	1802-2001-061	1802-2001-062	1802-2001-232	NA
5'	1802-2001-065	1802-2001-066	1802-2001-067	1802-2001-068	1802-2001-242	NA
6'	1802-2001-071	1802-2001-072	1802-2001-073	1802-2001-074	1802-2001-252	1802-2001-253
8'	NA	1802-2001-077	1802-2001-078	1802-2001-079	1802-2001-262	1802-2001-263
10'	NA	1802-2001-081	1802-2001-082	1802-2001-083	1802-2001-272	1802-2001-273
<b>*ELEMENT (125 WATTS/FT)</b>						
<b>28" HEATER</b>	1802-2001-085	1802-2001-086	1802-2001-048	1802-2001-049	NA	NA
3'	1802-2001-087	1802-2001-088	1802-2001-054	1802-2001-055	1802-2001-220	NA
4'	1802-2001-089	1802-2001-090	1802-2001-060	1802-2001-061	1802-2001-230	NA
5'	1802-2001-091	1802-2001-092	1802-2001-066	1802-2001-067	1802-2001-240	1802-2001-241
6'	1802-2001-093	1802-2001-094	1802-2001-072	1802-2001-073	1802-2001-250	1802-2001-251
8'	NA	1802-2001-095	1802-2001-077	1802-2001-078	1802-2001-260	1802-2001-261
10'	NA	1802-2001-096	1802-2001-081	1802-2001-082	1802-2001-270	1802-2001-271
<b>*ELEMENT (150 WATTS/FT)</b>						
<b>28" HEATER</b>	1802-2001-051	1802-2001-001	1802-2001-000	1802-2001-052	NA	NA
3'	1802-2001-057	1802-2001-007	1802-2001-006	1802-2001-058	1802-2001-218	NA
4'	1802-2001-063	1802-2001-013	1802-2001-012	1802-2001-064	1802-2001-228	NA
5'	1802-2001-069	1802-2001-019	1802-2001-018	1802-2001-070	1802-2001-238	1802-2001-239
6'	1802-2001-075	1802-2001-025	1802-2001-024	1802-2001-076	1802-2001-248	1802-2001-249
8'	NA	1802-2001-031	1802-2001-030	1802-2001-080	1802-2001-258	1802-2001-259
10'	NA	1802-2001-035	1802-2001-034	1802-2001-084	1802-2001-268	1802-2001-269
<b>*ELEMENT (188 WATTS/FT)</b>						
<b>28" HEATER</b>	1802-2001-005	1802-2001-002	1802-2001-001	1802-2001-000	NA	NA
3'	1802-2001-011	1802-2001-008	1802-2001-007	1802-2001-006	1802-2001-216	NA
4'	1802-2001-017	1802-2001-014	1802-2001-013	1802-2001-012	1802-2001-226	1802-2001-227
5'	1802-2001-023	1802-2001-020	1802-2001-019	1802-2001-018	1802-2001-236	1802-2001-237
6'	1802-2001-029	1802-2001-026	1802-2001-025	1802-2001-024	1802-2001-246	1802-2001-247
8'	NA	1802-2001-032	1802-2001-031	1802-2001-030	1802-2001-256	1802-2001-257
10'	NA	1802-2001-036	1802-2001-035	1802-2001-034	1802-2001-266	1802-2001-267
<b>*ELEMENT (250 WATTS/FT)</b>						
<b>28" HEATER</b>	1802-2001-004	1802-2001-003	1802-2001-002	1802-2001-001	1802-2001-202	NA
3'	1802-2001-010	1802-2001-009	1802-2001-008	1802-2001-007	1802-2001-214	NA
4'	1802-2001-016	1802-2001-015	1802-2001-014	1802-2001-013	1802-2001-224	1802-2001-225
5'	1802-2001-022	1802-2001-021	1802-2001-020	1802-2001-019	1802-2001-234	1802-2001-235
6'	1802-2001-028	1802-2001-027	1802-2001-026	1802-2001-025	1802-2001-244	1802-2001-245
8'	NA	1802-2001-033	1802-2001-032	1802-2001-031	1802-2001-254	1802-2001-255
10'	NA	1802-2001-037	1802-2001-036	1802-2001-035	1802-2001-264	1802-2001-265
<p>* 1, 2 OR 3 ELEMENTS MAY BE REQUIRED. VOLTAGE AND WATTAGE ARE STAMPED ON END OF ELEMENTS. DIVIDE THE WATTAGE BY THE HEATER LENGTH (FEET) TO DETERMINE WATTS/FOOT OF ELEMENT. THEN USE THIS DATA TO DETERMINE PART NUMBER OF HEATING ELEMENT.</p>						

DISCRIPTION	PART NUMBERS					
	120V	208V	240V	277V	347V	600V
<b>LINEAR LIMIT</b>						
<b>28" HEATER</b>	4520-0007-007	4520-0007-007	4520-0007-007	4520-0007-007	4520-0007-007	4520-0007-007
3'	4520-0007-008	4520-0007-008	4520-0007-008	4520-0007-008	4520-0007-008	4520-0007-008
4'	4520-0007-009	4520-0007-009	4520-0007-009	4520-0007-009	4520-0007-009	4520-0007-009
5'	4520-0007-010	4520-0007-010	4520-0007-010	4520-0007-010	4520-0007-010	4520-0007-010
6'	4520-0007-011	4520-0007-011	4520-0007-011	4520-0007-011	4520-0007-011	4520-0007-011
8'	NA	4520-0007-012	4520-0007-012	4520-0007-012	4520-0007-012	4520-0007-012
10'	NA	4520-0007-013	4520-0007-013	4520-0007-013	4520-0007-013	4520-0007-013
<b>DISCONNECT SW.</b>	<b>THERMOSTAT</b>	<b>TRANSFORMER</b>		<b>POWER RELAY</b>		
410170001	<b>2-STAGE</b> 5813-0023-000 <b>SINGLE POLE</b> 5813-0024-000	<b>120V</b> 5018-11003-000	<b>277V</b> 5018-11003-002 <b>347V</b> 5018-11003-003	<b>24V</b> 5018-2006-000 <b>120V</b> 5018-2021-001	<b>208/240V</b> 5018-2006-002 <b>277V</b> 5018-2006-003	









**SLQDB SERIES**

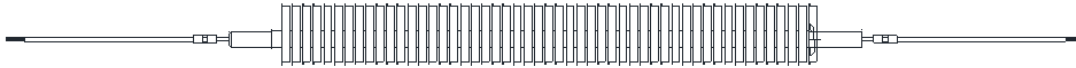

DISCRIPTION	PART NUMBERS					
	120V	208V	240V	277V	347V	600V
<b>*ELEMENT (100 WATTS/FT)</b>						
<b>28" HEATER</b>	1802-2001-047	1802-2001-048	1802-2001-049	NA	NA	NA
3'	1802-2001-053	1802-2001-054	1802-2001-055	1802-2001-056	NA	NA
4'	1802-2001-059	1802-2001-060	1802-2001-061	1802-2001-062	1802-2001-232	NA
5'	1802-2001-065	1802-2001-066	1802-2001-067	1802-2001-068	1802-2001-242	NA
6'	1802-2001-071	1802-2001-072	1802-2001-073	1802-2001-074	1802-2001-252	1802-2001-253
8'	NA	1802-2001-077	1802-2001-078	1802-2001-079	1802-2001-262	1802-2001-263
10'	NA	1802-2001-081	1802-2001-082	1802-2001-083	1802-2001-272	1802-2001-273
<b>*ELEMENT (125 WATTS/FT)</b>						
<b>28" HEATER</b>	1802-2001-085	1802-2001-086	1802-2001-048	1802-2001-049	NA	NA
3'	1802-2001-087	1802-2001-088	1802-2001-054	1802-2001-055	1802-2001-220	NA
4'	1802-2001-089	1802-2001-090	1802-2001-060	1802-2001-061	1802-2001-230	NA
5'	1802-2001-091	1802-2001-092	1802-2001-066	1802-2001-067	1802-2001-240	1802-2001-241
6'	1802-2001-093	1802-2001-094	1802-2001-072	1802-2001-073	1802-2001-250	1802-2001-251
8'	NA	1802-2001-095	1802-2001-077	1802-2001-078	1802-2001-260	1802-2001-261
10'	NA	1802-2001-096	1802-2001-081	1802-2001-082	1802-2001-270	1802-2001-271
<b>*ELEMENT (150 WATTS/FT)</b>						
<b>28" HEATER</b>	1802-2001-051	1802-2001-001	1802-2001-000	1802-2001-052	NA	NA
3'	1802-2001-057	1802-2001-007	1802-2001-006	1802-2001-058	1802-2001-218	NA
4'	1802-2001-063	1802-2001-013	1802-2001-012	1802-2001-064	1802-2001-228	NA
5'	1802-2001-069	1802-2001-019	1802-2001-018	1802-2001-070	1802-2001-238	1802-2001-239
6'	1802-2001-075	1802-2001-025	1802-2001-024	1802-2001-076	1802-2001-248	1802-2001-249
8'	NA	1802-2001-031	1802-2001-030	1802-2001-080	1802-2001-258	1802-2001-259
10'	NA	1802-2001-035	1802-2001-034	1802-2001-084	1802-2001-268	1802-2001-269
<b>*ELEMENT (188 WATTS/FT)</b>						
<b>24" HEATER</b>	1802-2001-038	1802-2001-039	1802-2001-040	1802-2001-041	1802-2001-200	NA
<b>28"</b>	1802-2001-005	1802-2001-002	1802-2001-001	1802-2001-000	NA	NA
3'	1802-2001-011	1802-2001-008	1802-2001-007	1802-2001-006	1802-2001-216	NA
4'	1802-2001-017	1802-2001-014	1802-2001-013	1802-2001-012	1802-2001-226	1802-2001-227
5'	1802-2001-023	1802-2001-020	1802-2001-019	1802-2001-018	1802-2001-236	1802-2001-237
6'	1802-2001-029	1802-2001-026	1802-2001-025	1802-2001-024	1802-2001-246	1802-2001-247
8'	NA	1802-2001-032	1802-2001-031	1802-2001-030	1802-2001-256	1802-2001-257
10'	NA	1802-2001-036	1802-2001-035	1802-2001-034	1802-2001-266	1802-2001-267
<b>LINEAR LIMIT</b>		<b>DISCONNECT SW.</b>	<b>THERMOSTAT</b>			
<b>28" HEATER</b>	4520-0007-007	410170001	<b>2-STAGE</b>	<b>SINGLE POLE</b>		
3'	4520-0007-008		5813-0023-000	410129002		
4'	4520-0007-009					
5'	4520-0007-010					
6'	4520-0007-011					
8'	4520-0007-012					
10'	4520-0007-013					

**DBSL SERIES**

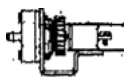

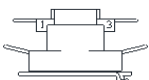
DISCRIPTION	PART NUMBERS					
	120V	208V	240V	277V	347V	600V
<b>*ELEMENT (100 WATTS/FT)</b>						
<b>28" HEATER</b>	1802-2001-047	1802-2001-048	1802-2001-049	NA	NA	NA
3'	1802-2001-053	1802-2001-054	1802-2001-055	1802-2001-056	NA	NA
4'	1802-2001-059	1802-2001-060	1802-2001-061	1802-2001-062	1802-2001-232	NA
5'	1802-2001-065	1802-2001-066	1802-2001-067	1802-2001-068	1802-2001-242	NA
6'	1802-2001-071	1802-2001-072	1802-2001-073	1802-2001-074	1802-2001-252	1802-2001-253
8'	NA	1802-2001-077	1802-2001-078	1802-2001-079	1802-2001-262	1802-2001-263
10'	NA	1802-2001-081	1802-2001-082	1802-2001-083	1802-2001-272	1802-2001-273
<b>*ELEMENT (125 WATTS/FT)</b>						
<b>28" HEATER</b>	1802-2001-085	1802-2001-086	1802-2001-048	1802-2001-049	NA	NA
3'	1802-2001-087	1802-2001-088	1802-2001-054	1802-2001-055	1802-2001-220	NA
4'	1802-2001-089	1802-2001-090	1802-2001-060	1802-2001-061	1802-2001-230	NA
5'	1802-2001-091	1802-2001-092	1802-2001-066	1802-2001-067	1802-2001-240	1802-2001-241
6'	1802-2001-093	1802-2001-094	1802-2001-072	1802-2001-073	1802-2001-250	1802-2001-251
8'	NA	1802-2001-095	1802-2001-077	1802-2001-078	1802-2001-260	1802-2001-261
10'	NA	1802-2001-096	1802-2001-081	1802-2001-082	1802-2001-270	1802-2001-271
<b>*ELEMENT (150 WATTS/FT)</b>						
<b>28" HEATER</b>	1802-2001-051	1802-2001-001	1802-2001-000	1802-2001-052	NA	NA
3'	1802-2001-057	1802-2001-007	1802-2001-006	1802-2001-058	1802-2001-218	NA
4'	1802-2001-063	1802-2001-013	1802-2001-012	1802-2001-064	1802-2001-228	NA
5'	1802-2001-069	1802-2001-019	1802-2001-018	1802-2001-070	1802-2001-238	1802-2001-239
6'	1802-2001-075	1802-2001-025	1802-2001-024	1802-2001-076	1802-2001-248	1802-2001-249
8'	NA	1802-2001-031	1802-2001-030	1802-2001-080	1802-2001-258	1802-2001-259
10'	NA	1802-2001-035	1802-2001-034	1802-2001-084	1802-2001-268	1802-2001-269
<b>*ELEMENT (188 WATTS/FT)</b>						
<b>24" HEATER</b>	1802-2001-038	1802-2001-039	1802-2001-040	1802-2001-041	1802-2001-200	NA
<b>28"</b>	1802-2001-005	1802-2001-002	1802-2001-001	1802-2001-000	NA	NA
3'	1802-2001-011	1802-2001-008	1802-2001-007	1802-2001-006	1802-2001-216	NA
4'	1802-2001-017	1802-2001-014	1802-2001-013	1802-2001-012	1802-2001-226	1802-2001-227
5'	1802-2001-023	1802-2001-020	1802-2001-019	1802-2001-018	1802-2001-236	1802-2001-237
6'	1802-2001-029	1802-2001-026	1802-2001-025	1802-2001-024	1802-2001-246	1802-2001-247
8'	NA	1802-2001-032	1802-2001-031	1802-2001-030	1802-2001-256	1802-2001-257
10'	NA	1802-2001-036	1802-2001-035	1802-2001-034	1802-2001-266	1802-2001-267
<b>*ELEMENT (250 WATTS/FT)</b>						
<b>28" HEATER</b>	1802-2001-004	1802-2001-003	1802-2001-002	1802-2001-001	1802-2001-202	NA
3'	1802-2001-010	1802-2001-009	1802-2001-008	1802-2001-007	1802-2001-214	NA
4'	1802-2001-016	1802-2001-015	1802-2001-014	1802-2001-013	1802-2001-224	1802-2001-225
5'	1802-2001-022	1802-2001-021	1802-2001-020	1802-2001-019	1802-2001-234	1802-2001-235
6'	1802-2001-028	1802-2001-027	1802-2001-026	1802-2001-025	1802-2001-244	1802-2001-245
8'	NA	1802-2001-033	1802-2001-032	1802-2001-031	1802-2001-254	1802-2001-255
10'	NA	1802-2001-037	1802-2001-036	1802-2001-035	1802-2001-264	1802-2001-265
						
<b>LINEAR LIMIT</b>	<b>DISCONNECT SW.</b>	<b>THERMOSTAT</b>	<b>P.E. SWITCH</b>			
<b>28" HEATER</b>	4520-0007-007	410170001	<b>2-STAGE</b>	410172001		
3'	4520-0007-008		5813-0023-000			
4'	4520-0007-009		<b>SINGLE POLE</b>			
5'	4520-0007-010		5813-0024-000			
6'	4520-0007-011					
8'	4520-0007-012					
10'	4520-0007-013					
						
<b>TRANSFORMER</b>	<b>POWER RELAY</b>					
120V	277V	24V	208/240V			
5018-11003-000	5018-11003-002	410171001	410171003			
<b>208/240V</b>	<b>347V</b>	<b>120V</b>				
5018-11003-001	5018-11003-003	410171002				



ST SERIES

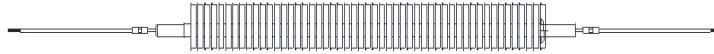

DISCRPTION	PART NUMBERS					
	120V	208V	240V	277V	347V	600V
<b>*ELEMENT (125 WATTS/FT)</b>						
<b>28" HEATER</b>	1802-2001-085	1802-2001-086	1802-2001-048	1802-2001-049	NA	NA
3'	1802-2001-087	1802-2001-088	1802-2001-054	1802-2001-055	1802-2001-220	NA
4'	1802-2001-089	1802-2001-090	1802-2001-060	1802-2001-061	1802-2001-230	NA
5'	1802-2001-091	1802-2001-092	1802-2001-066	1802-2001-067	1802-2001-240	1802-2001-241
6'	1802-2001-093	1802-2001-094	1802-2001-072	1802-2001-073	1802-2001-250	1802-2001-251
8'	NA	1802-2001-095	1802-2001-077	1802-2001-078	1802-2001-260	1802-2001-261
10'	NA	1802-2001-096	1802-2001-081	1802-2001-082	1802-2001-270	1802-2001-271
<b>*ELEMENT (188 WATTS/FT)</b>						
<b>28" HEATER</b>	1802-2001-005	1802-2001-002	1802-2001-001	1802-2001-000	NA	NA
3'	1802-2001-011	1802-2001-008	1802-2001-007	1802-2001-006	1802-2001-216	NA
4'	1802-2001-017	1802-2001-014	1802-2001-013	1802-2001-012	1802-2001-226	1802-2001-227
5'	1802-2001-023	1802-2001-020	1802-2001-019	1802-2001-018	1802-2001-236	1802-2001-237
6'	1802-2001-029	1802-2001-026	1802-2001-025	1802-2001-024	1802-2001-246	1802-2001-247
8'	NA	1802-2001-032	1802-2001-031	1802-2001-030	1802-2001-256	1802-2001-257
10'	NA	1802-2001-036	1802-2001-035	1802-2001-034	1802-2001-266	1802-2001-267
<b>*ELEMENT (250 WATTS/FT)</b>						
<b>28" HEATER</b>	1802-2001-004	1802-2001-003	1802-2001-002	1802-2001-001	1802-2001-202	NA
3'	1802-2001-010	1802-2001-009	1802-2001-008	1802-2001-007	1802-2001-214	NA
4'	1802-2001-016	1802-2001-015	1802-2001-014	1802-2001-013	1802-2001-224	1802-2001-225
5'	1802-2001-022	1802-2001-021	1802-2001-020	1802-2001-019	1802-2001-234	1802-2001-235
6'	1802-2001-028	1802-2001-027	1802-2001-026	1802-2001-025	1802-2001-244	1802-2001-245
8'	NA	1802-2001-033	1802-2001-032	1802-2001-031	1802-2001-254	1802-2001-255
10'	NA	1802-2001-037	1802-2001-036	1802-2001-035	1802-2001-264	1802-2001-265



DISCRPTION	PART NUMBERS					
	120V	208V	240V	277V	347V	600V
<b>LINEAR LIMIT</b>						
<b>28" HEATER</b>	4520-2018-001	4520-2018-001	4520-2018-001	4520-2018-001	4520-2018-001	4520-2018-001
3'	4520-2018-002	4520-2018-002	4520-2018-002	4520-2018-002	4520-2018-002	4520-2018-002
4'	4520-2018-003	4520-2018-003	4520-2018-003	4520-2018-003	4520-2018-003	4520-2018-003
5'	4520-2018-004	4520-2018-004	4520-2018-004	4520-2018-004	4520-2018-004	4520-2018-004
6'	4520-2018-005	4520-2018-005	4520-2018-005	4520-2018-005	4520-2018-005	4520-2018-005
8'	NA	4520-2018-006	4520-2018-006	4520-2018-006	4520-2018-006	4520-2018-006
10'	NA	4520-2018-007	4520-2018-007	4520-2018-007	4520-2018-007	4520-2018-007
<b>DISCONNECT SW.</b>	<b>THERMOSTAT</b>	<b>TRANSFORMER RELAY</b>		<b>J-BOX COVER</b>	<b>FRONT COVER</b>	
DS	<b>2-STAGE</b> 5813-0023-000 <b>SINGLE POLE</b> 5813-0024-000	<b>120V</b> 5018-11003-000 <b>208/240V</b> 5018-11003-001	<b>277V</b> 5018-11003-002 <b>347V</b> 5018-11003-003	<b>ALL MODELS</b> 1402-2250-000	1402-2251-000 1402-2251-001 1402-2251-002 1402-2251-003 1402-2251-004 1402-2251-005 1402-2251-006	28" 3' 4' 5' 6' 8' 10'

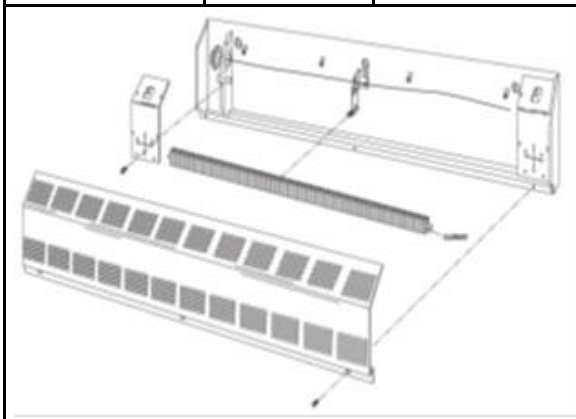



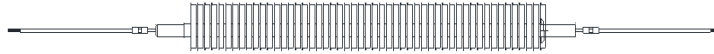

**CSH, DSH, CPH & DPH SERIES**



DISCRPTION	PART NUMBERS					
	120V	208V	240V	277V	347V	600V
<b>*ELEMENT (125 WATTS/FT)</b>						
<b>28" HEATER</b>	1802-2001-085	1802-2001-086	1802-2001-048	1802-2001-049	NA	NA
3'	1802-2001-087	1802-2001-088	1802-2001-054	1802-2001-055	1802-2001-220	NA
4'	1802-2001-089	1802-2001-090	1802-2001-060	1802-2001-061	1802-2001-230	NA
5'	1802-2001-091	1802-2001-092	1802-2001-066	1802-2001-067	1802-2001-240	1802-2001-241
6'	1802-2001-093	1802-2001-094	1802-2001-072	1802-2001-073	1802-2001-250	1802-2001-251
8'	NA	1802-2001-095	1802-2001-077	1802-2001-078	1802-2001-260	1802-2001-261
10'	NA	1802-2001-096	1802-2001-081	1802-2001-082	1802-2001-270	1802-2001-271
<b>*ELEMENT (188 WATTS/FT)</b>						
<b>28" HEATER</b>	1802-2001-005	1802-2001-002	1802-2001-001	1802-2001-000	NA	NA
3'	1802-2001-011	1802-2001-008	1802-2001-007	1802-2001-006	1802-2001-216	NA
4'	1802-2001-017	1802-2001-014	1802-2001-013	1802-2001-012	1802-2001-226	1802-2001-227
5'	1802-2001-023	1802-2001-020	1802-2001-019	1802-2001-018	1802-2001-236	1802-2001-237
6'	1802-2001-029	1802-2001-026	1802-2001-025	1802-2001-024	1802-2001-246	1802-2001-247
8'	NA	1802-2001-032	1802-2001-031	1802-2001-030	1802-2001-256	1802-2001-257
10'	NA	1802-2001-036	1802-2001-035	1802-2001-034	1802-2001-266	1802-2001-267
<b>*ELEMENT (250 WATTS/FT)</b>						
<b>28" HEATER</b>	1802-2001-004	1802-2001-003	1802-2001-002	1802-2001-001	1802-2001-202	NA
3'	1802-2001-010	1802-2001-009	1802-2001-008	1802-2001-007	1802-2001-214	NA
4'	1802-2001-016	1802-2001-015	1802-2001-014	1802-2001-013	1802-2001-224	1802-2001-225
5'	1802-2001-022	1802-2001-021	1802-2001-020	1802-2001-019	1802-2001-234	1802-2001-235
6'	1802-2001-028	1802-2001-027	1802-2001-026	1802-2001-025	1802-2001-244	1802-2001-245
8'	NA	1802-2001-033	1802-2001-032	1802-2001-031	1802-2001-254	1802-2001-255
10'	NA	1802-2001-037	1802-2001-036	1802-2001-035	1802-2001-264	1802-2001-265

\* 1, 2 OR 3 ELEMENTS MAY BE REQUIRED. VOLTAGE AND WATTAGE ARE STAMPED ON END OF ELEMENTS. DIVIDE THE WATTAGE BY THE HEATER LENGTH (FEET) TO DETERMINE WATTS/FOOT OF ELEMENT. THEN USE THIS DATA TO DETERMINE PART NUMBER OF HEATING ELEMENT.



DISCRPTION	PART NUMBERS					
	120V	208V	240V	277V	347V	600V
<b>LINEAR LIMIT</b>						
<b>28" HEATER</b>	4520-0007-007	4520-0007-007	4520-0007-007	4520-0007-007	4520-0007-007	4520-0007-007
3'	4520-0007-008	4520-0007-008	4520-0007-008	4520-0007-008	4520-0007-008	4520-0007-008
4'	4520-0007-009	4520-0007-009	4520-0007-009	4520-0007-009	4520-0007-009	4520-0007-009
5'	4520-0007-010	4520-0007-010	4520-0007-010	4520-0007-010	4520-0007-010	4520-0007-010
6'	4520-0007-011	4520-0007-011	4520-0007-011	4520-0007-011	4520-0007-011	4520-0007-011
8'	NA	4520-0007-012	4520-0007-012	4520-0007-012	4520-0007-012	4520-0007-012
10'	NA	4520-0007-013	4520-0007-013	4520-0007-013	4520-0007-013	4520-0007-013
<b>DISCONNECT SW.</b>	<b>THERMOSTAT</b>	<b>TRANSFORMER RELAY</b>		<b>24V TRANSFORMER</b>	<b>PNEUMATIC CONTROL</b>	
						
410170001	<b>2-STAGE</b> 5813-0023-000 <b>SINGLE POLE</b> 5813-0024-000	<b>120V</b> 5018-11003-000 <b>208/240V</b> 5018-11003-001	<b>277V</b> 5018-11003-002 <b>347V</b> 5018-11003-003	<b>208/240V PRIMARY</b> 490026001 <b>277V PRIMARY</b> 490026002	<b>ALL MODELS</b> 5216-7027-005	



CIRCUIT BREAKER	POWER RELAY	
	24V	277V
		
<b>2-POLE, 30A</b> 1226-7009-013 <b>2-POLE, 60A</b> 1226-7009-010 <b>3-POLE, 30A</b> 1226-7009-005 <b>3-POLE, 60A</b> 1226-7009-002	<b>24V</b> 5018-2021-001 <b>120V</b> 5018-2021-001 <b>208/240V</b> 5018-2021-002	<b>277V</b> 410171003



THX FLOOR DROP-IN CONVECTOR									
ELEMENTS									
<b>2 FOOT 188W/FT</b>		<b>2 FOOT 250W/FT</b>		<b>3 FOOT 188W/FT</b>		<b>3 FOOT 250W/FT</b>			
208V	1802-2001-039	208V	1802-2001-198	208V	1802-2001-008	208V	1802-2001-009		
240V	1802-2001-040	240V	1802-2001-099	240V	1802-2001-007	240V	1802-2001-008		
277V	1802-2001-041	277V	1802-2001-200	277V	1802-2001-006	277V	1802-2001-007		
<b>4 FOOT 188W/FT</b>		<b>4 FOOT 250W/FT</b>		<b>5 FOOT 188W/FT</b>		<b>5 FOOT 250W/FT</b>			
208V	1802-2001-014	208V	1802-2001-015	208V	1802-2001-020	208V	1802-2001-021		
240V	1802-2001-013	240V	1802-2001-014	240V	1802-2001-019	240V	1802-2001-020		
277V	1802-2001-012	277V	1802-2001-013	277V	1802-2001-018	277V	1802-2001-019		
GRILLE									
<b>2 FOOT FLUSH</b>		<b>2 FOOT SURFACE</b>		<b>3 FOOT FLUSH</b>		<b>3 FOOT SURFACE</b>			
ALUMINUM	2501-11033-001	ALUMINUM	2501-11033-005	ALUMINUM	2501-11033-002	ALUMINUM	2501-11033-006		
BLACK	2501-11033-101	BLACK	2501-11033-105	BLACK	2501-11033-102	BLACK	2501-11033-106		
WHITE	2501-11033-201	WHITE	2501-11033-205	WHITE	2501-11033-202	WHITE	2501-11033-206		
<b>4 FOOT FLUSH</b>		<b>4 FOOT SURFACE</b>		<b>5 FOOT FLUSH</b>		<b>5 FOOT SURFACE</b>			
ALUMINUM	2501-11033-003	ALUMINUM	2501-11033-007	ALUMINUM	2501-11033-004	ALUMINUM	2501-11033-008		
BLACK	2501-11033-103	BLACK	2501-11033-107	BLACK	2501-11033-104	BLACK	2501-11033-108		
WHITE	2501-11033-203	WHITE	2501-11033-207	WHITE	2501-11033-204	WHITE	2501-11033-208		
TRANSFORMER				TIME DELAY RELAY					
<b>277V</b>		<b>208/240V</b>		<b>24V CONTROL</b>		<b>120V CONTROL</b>		<b>208-277V CONTROL</b>	
5108-11003-002		5108-11003-001		410171001		410171002		410171003	
LINEAR LIMIT									
<b>2 FOOT</b>		<b>3 FOOT</b>		<b>4 FOOT</b>		<b>5 FOOT</b>		<b>POWER ON/OFF SW</b>	
4520-0007-007		4520-0007-008		4520-0007-009		4520-0007-010		ALL MODELS	
								410170001	
MANUAL RESET LIMIT									
<b>2 FOOT</b>		<b>3 FOOT</b>		<b>4 FOOT</b>		<b>5 FOOT</b>		<b>J-BOX COVER</b>	
4520-2017-000		4520-2017-000		4520-2017-001		4520-2017-001		ALL MODELS	
								1215-11125-000	

## BRM SERIES

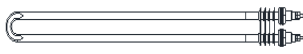
### ELEMENT

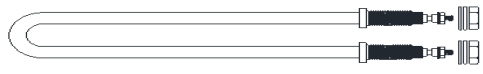
					
<b>1802-7076-002</b> M2081B M6083B	<b>1802-7076-007</b> M4581B M13583B	<b>1802-2110-007</b> M6043A	<b>HE45208</b> M4581 M13583	<b>HE20208</b> M6083	
<b>1802-7076-003</b> M2021B M6023B	<b>1802-7076-008</b> M4521B M13523B	<b>1802-2110-009</b> M4581A M13583A	<b>HE45240</b> M4521 M13523	<b>HE20240</b> M6023	
<b>1802-7076-004</b> M6071B	<b>1802-7076-009</b> M13571B	<b>1802-2110-011</b> M4521A M13523A	<b>HE45480</b> M4541 M13543	<b>HE20480</b> M6043	
<b>1802-7076-005</b> M2041B M6043B	<b>1802-7076-010</b> M4541B M13543B	<b>1802-2110-015</b> M4541A M13543A	<b>HE45600</b> M13563	<b>HE20600</b> M6063	
<b>1802-7076-006</b> M2061B M6063B	<b>1802-7076-011</b> M4561B M13563B	<b>1802-2110-016</b> M13563A			

**NOTES**







6KW AND 13.5KW UNITS TAKE THREE ELEMENTS





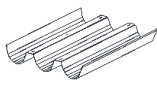

### REFLECTOR

<b>891755004</b> M6023B M6043B	<b>891755002</b> M13523B M13543B M4521B M4541B
--------------------------------------	--

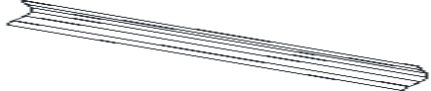
**FRP/FRS SERIES RADIANT HEATERS**

ELEMENTS					REFLECTOR			
								
PART NUMBER	TYPE	VOLTS	WATTS	USED WITH FIXTURE	5007-2003-000	5007-2003-001	5007-2003-002	
2MS08208 2MS08240 2MS08277 2MS08347 2MS08480 2MS08600	METAL SHEATH	208 240 277 347 480 600	850	RP22 RS22 RP32 RS32	RP223ASA RS223ASA	RP233ASA RS233ASA	RP243ASA RS243ASA	
2QT10208 2QT10240 2QT10277 NA	QUARTS TUBE	208 240 277 NA	1000		5007-2010-000 RP223SA RS223SA	5007-2010-001 RP233SA RS233SA	5007-2010-002 RP243SA RS243SA	
2QL16208 2QL16240 2QL16277 2QL16347 2QL16480 2QL16600	QUARTS LAMP	208 240 277 347 480 600	1600		5007-2011-000 RP226ASA RS226ASA	5007-2011-001 RP236ASA RS236ASA	5007-2011-002 RP246ASA RS246ASA	
3MS15208 3MS15240 3MS15277 3MS15347 3MS15480 3MS15600	METAL SHEATH	208 240 277 347 480 600	1500		RP23 RS23 RP33 RS33	5007-2009-000 RP226SA RP229SA RS226SA RS229SA	5007-2009-001 RP236SA RP239SA RS236SA RS239SA	5007-2009-002 RP246SA RP249SA RS246SA RS249SA
3QT15208 3QT15240 3QT15277 3QT15347 3QT15480 3QT15600	QUARTS TUBE	208 240 277 347 480 600	1500					
3QL25208 3QL25240 3QL25277 3QL25347 3QL25480 3QL25600	QUARTS LAMP	208 240 277 347 480 600	2500			5007-2008-000 RP323ASA RS323ASA	5007-2008-001 RP333ASA RS333ASA	5007-2008-002 RP343ASA RS343ASA
3QT15208 3QT15240 3QT15277 3QT15347 3QT15480 3QT15600	QUARTS TUBE	208 240 277 347 480 600	1500	5007-2017-000 RP323SA RS323SA		5007-2017-001 RP333SA RS333SA	5007-2017-002 RP343SA RS343SA	
3QL25208 3QL25240 3QL25277 3QL25347 3QL25480 3QL25600	QUARTS LAMP	208 240 277 347 480 600	2500	5007-2018-000 RP326ASA RS326ASA		5007-2018-001 RP336ASA RS336ASA	5007-2018-002 RP346ASA RS346ASA	
3QL25208 3QL25240 3QL25277 3QL25347 3QL25480 3QL25600	QUARTS LAMP	208 240 277 347 480 600	2500	5007-2016-000 RP326SA RP329SA RS326SA RS329SA		5007-2016-001 RP336SA RP339SA RS336SA RS339SA	5007-2016-002 RP346SA RP349SA RS346SA RS349SA	
4MS20208 4MS20240 4MS20277 4MS20347 4MS20480 4MS20600	METAL SHEATH	208 240 277 347 480 600	2000	RP24 RS24 RP34 RS34				
4QT20208 4QT20240 4QT20277 4QT20347 4QT20480 4QT20600	QUARTS TUBE	208 240 277 347 480 600	2000		ELEMENT TERM BUSH*		TERMINAL BLOCK*	
4QL36347 4QL36480 4QL36600	QUARTS LAMP	347 480 600	3650		ALL MODELS 1213-0070-000		ALL MODELS 1224-0049-000	
NOTES					* FOUR REQUIRED ON 2 ELEMENT AND SIX FOR 3 ELEMENT FIXTURES			
								
								

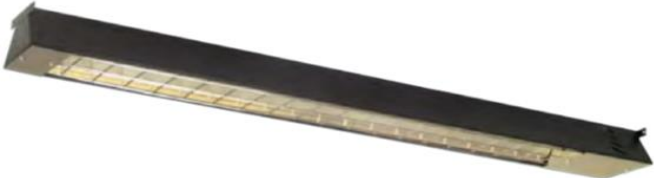
HRK SERIES			
ELEMENT		REFLECTOR	
			
1802-2113-501 RK41512A	1802-2113-515 RK53020A	5007-2013-000 RK41512A RK42020A RK42024A RK42027A RK42034A RK42048A RK42060A	5007-2013-001 RK53020A RK53024A RK53027A RK53034A RK53048A RK53060A
1802-2113-509 RK42020A	1802-2113-516 RK53024A		
1802-2113-510 RK42024A	1802-2113-517 RK53027A		
1802-2113-511 RK42027A	1802-2113-518 RK53034A		
1802-2113-512 RK42034A	1802-2113-519 RK53048A		
1802-2113-513 RK42048A	1802-2113-520 RK53060A		
1802-2113-514 RK42060A			
CHAIN 2 REQ.	"S" HOOK 4 REQ.		
			
1404-2000-001 ALL MODELS	2706-2000-000 ALL MODELS	1402-2275-000 ALL MODELS	1402-2275-001 ALL MODELS
			



# RCC COVE HEATERS (C & D SERIES)

## PARTS KIT\*

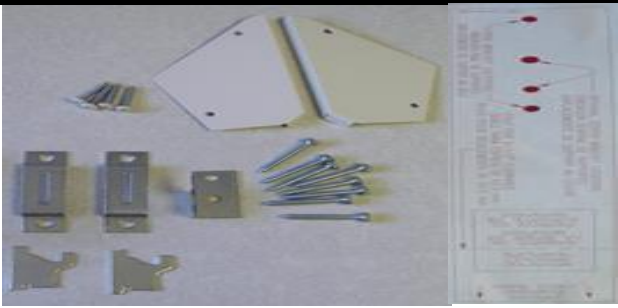

<b>WHITE</b> 3303-2032-000	<b>DOVE GRAY</b> 3303-2032-001	<b>DESERT TAN</b> 3303-2032-002
<b>CENTER SUP BRACKET**</b>	<b>THERMOSTAT</b>	<b>THERMOSTAT KNOB</b>
<b>ALL MODELS</b> 1215-2309-000	<b>ALL MODELS</b> 410129001	<b>ALL MODELS</b> 3301-2020-006













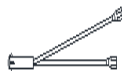

**NOTES**

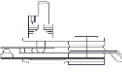

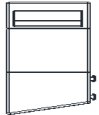

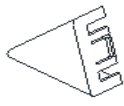





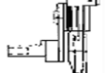

REPLACE HEATER IF FRONT COVER OR ELEMENT IS NEEDED

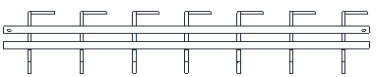
\* PARTS KIT INCLUDES MOUNTING BRACKETS, MOUNTING TEMPLATE, AND END CAPS





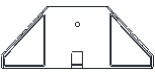

\*\* 1500 & 1800 WATT MODELS TAKE TWO CENTER SUPPORT BRACKETS

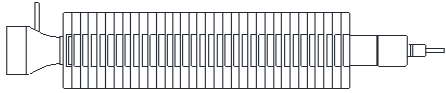

FBE SERIES					
ELEMENT		SWITCH			LIGHT
					
1802-2087-000 FBE15002C FBE15002CA		<del>5216-2007-000</del> FBE1000A FBE1200 FBE1250A	5216-2010-000 FBE15002 FBE15002A	5216-2027-000 FBE15002B FBE15002C FBE15002CA	3510-2008-001 FBE1504C
LIMIT	THERMOSTAT	KNOB		FACE PLATE	
					
4520-2011-004 FBE1500C FBE15002A FBE15002B FBE15002C FBE15002CA	5813-2058-001 FBE1200 FBE1200C FBE1500C FBE15002B FBE15002C FBE15002CA FBE1504C	3301-2017-000 FBE1000A FBE1250A FBE15002 FBE15002A	3301-2011-003 FBE1200 FBE1200C FBE1500C FBE15002B FBE15002C FBE15002CA FBE1504C	1402-2122-139 FBE1000A	1402-2122-136 FBE15002
				1402-2122-141 FBE1200	1402-2122-138 FBE15002A
				1402-2122-125 FBE1200C	1402-2122-142 FBE15002B
				1402-2122-140 FBE1250A	1402-2122-626 FBE15002CA
END CAP RIGHT	END CAP LEFT	LEG RIGHT	LEG LEFT	CORD	CONTROL COVER
					
1800-2047-001 FBE1200C FBE1500C FBE15002C FBE15002CA FBE1504C	1800-2048-001 FBE1200C FBE1500C FBE15002C FBE15002CA FBE1504C	3507-2004-001 FBE1200C FBE1500C FBE15002C FBE15002CA FBE1504C	3507-2005-001 FBE1200C FBE1500C FBE15002C FBE15002CA FBE1504C	1420-2027-001 FBE15002C 1420-11013-000 FBE15002CA	1402-2243-001 FBE15002B FBE15002C FBE15002CA
					

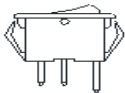
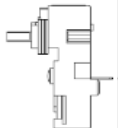
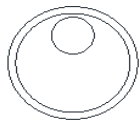

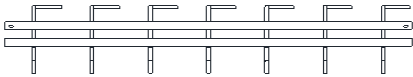
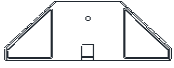

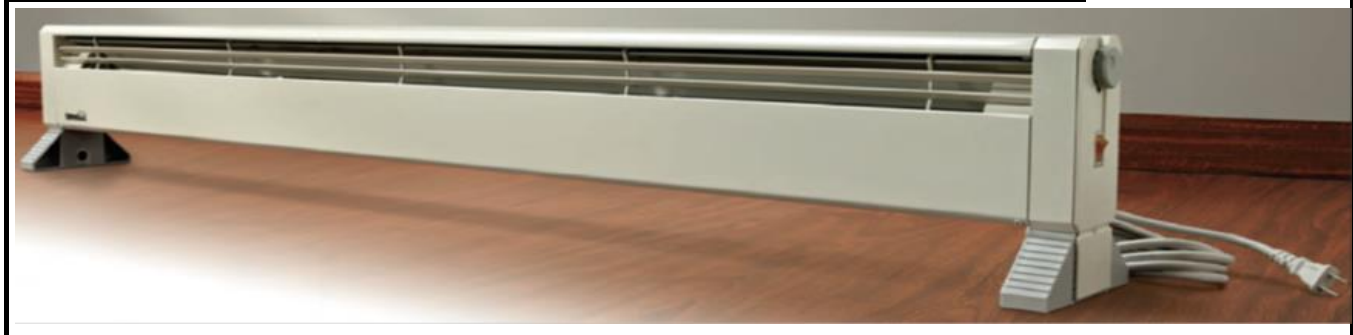

LFP SERIES (OBSOLETE)					
ELEMENT		THERMOSTAT		LIMIT	
					
1802-2067-023 LFP6152D LFP6152E LFP6152EA	1802-2067-001 LFP675D	5813-2019-000 LFP6152 LFP6152D LFP6152E LFP6152EA	5813-2001-000 LFP675 LFP675D	410163004 LFP6152 LFP6152D LFP6152E LFP6152EA	4520-2010-001 LFP675 LFP675D
GRILLE		LIGHT	DIODE BRIDGE	FRONT COVER	CORD
					
2501-2012-015 LFP6152 LFP6152D LFP6152E LFP6152EA	2501-2012-013 LFP675 LFP675D	3510-2006-000 LFP6152 LFP6152D LFP6152E LFP6152EA	DBKIT LFP6152 LFP6152D LFP6152E LFP6152EA	1402-2066-609 LFP6152EA	1420-11013-000 LFP6152D LFP6152E LFP6152EA
KNOB	LEG	SWITCH	END CAP		
					
3301-2011-001 LFP6152 LFP6152D LFP6152E LFP6152EA LFP675 LFP675D	3507-2003-000 LFP6152 LFP6152D LFP6152E LFP6152EA LFP675 LFP675D	<del>5216-2007-000</del> LFP6152 LFP6152D LFP6152E LFP6152EA LFP675 LFP675D	1800-2027-000 LFP6152 LFP6152D LFP6152E LFP6152EA LFP675 LFP675D		

## FHP SERIES







ELEMENT		LIMIT		SWITCH
				
<b>1802-2067-001</b> FHP0750KCT FHP0750KCTA FHP0750T FHP0750TA	<b>1802-2067-023</b> FHP1500KCT FHP1500KCTA FHP1500T FHP1500TA	<b>4520-0011-000</b> FHP0750KCT FHP0750KCTA FHP0750T FHP0750TA	<b>410163004</b> FHP1500KCT FHP1500KCTA FHP1500T FHP1500TA	<b>5216-11020-000</b> FHP0750KCT FHP0750KCTA FHP0750T FHP0750TA FHP1500KCT FHP1500KCTA FHP1500T FHP1500TA
THERMOSTAT	KNOB	FRONT COVER		END CAP
				
<b>5813-11012-000</b> FHP0750KCT FHP0750KCTA FHP0750T FHP0750TA FHP1500KCT FHP1500KCTA FHP1500T FHP1500TA	<b>3301-2011-005</b> FHP0750KCT FHP0750KCTA FHP0750T FHP0750TA FHP1500KCT FHP1500KCTA FHP1500T FHP1500TA	<b>1402-2066-607</b> FHP0750KCT FHP0750KCTA FHP0750T FHP0750TA	<b>1402-2066-609</b> FHP1500KCT FHP1500KCTA FHP1500T FHP1500TA	<b>1800-2027-000</b> FHP0750KCT FHP0750KCTA FHP0750T FHP0750TA FHP1500KCT FHP1500KCTA FHP1500T FHP1500TA
GRILLE		LEGS (2 REQ)	CORD	
				
<b>2501-2012-013</b> FHP0750KCT FHP0750KCTA FHP0750T FHP0750TA	<b>2501-2012-015</b> FHP1500KCT FHP1500KCTA FHP1500T FHP1500TA	<b>3507-2003-000</b> FHP0750KCT FHP0750KCTA FHP0750T FHP0750TA FHP1500KCT FHP1500KCTA FHP1500T FHP1500TA	<b>1420-11013-000</b> FHP0750KCT FHP0750KCTA FHP0750T FHP0750TA FHP1500KCT FHP1500KCTA FHP1500T FHP1500TA	

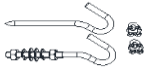

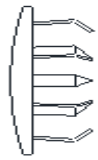
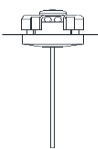

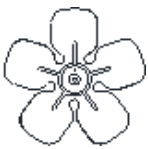

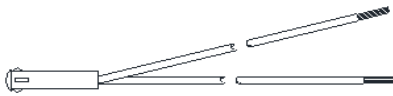
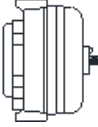
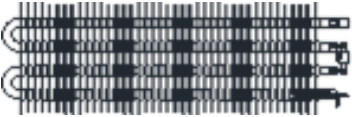





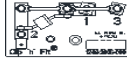

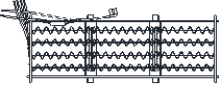
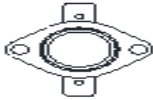

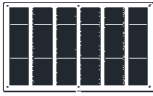

**DOE INDUSTRIAL & COMMERCIAL CEILING FANS**

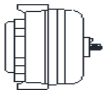
			<b>ASSEMBLY HAS SHACKLE AND RUBBER ROLLER</b>					
<b>MODEL</b>	<b>BLADES SET OF 3</b>	<b>MOTOR</b>	<b>DOWN ROD</b>	<b>SHACKLE</b>	<b>UPPER CANOPY</b>	<b>LOWER CANOPY</b>	<b>RUBBER ROLLER</b>	<b>SPEED CONTROL</b>
56001HP	9B5600-1HP	9M5600-1HP	9D24BW	9F2900-03A	9F2900-07A	9F2900-08A	9F2900-04A	12003
56001HP-BRN	9B5600-1HPB		9D24BB	9F2900-03A	9FP029	9FP030	9F2900-04A	12003
56001HPDOE-K	9B5600-1HP	9M5600-1HP	9D24BW	9F2900-03A	9F2900-07A	9F2900-08A	9F2900-04A	12003
56001HPDOEBRN-K	9B5600-1HPB		9D24BB	9F2900-03A	9FP029	9FP030	9F2900-04A	12003
56001LCCDOE	9B5600-1LCC	9M5600-1LCC	9D24BW	9F2900-03A	9F2900-07A	9F2900-08A	9F2900-04A	CTL12004RSPDDOE
56001LCCDOE-K	9B5600-1LCC	9M5600-1LCC	9D24BW	9F2900-03A	9F2900-07A	9F2900-08A	9F2900-04A	CTL12004RSPDDOE
56201CLSDOE	9B56201CLS-1	9M56201CLS-1	9D24BW	9F2900-03A	9F2900-07A	9F2900-08A	9F2900-04A	CTL12004RSPDDOE
56201CLSDOE-K	9B56201CLS-1	9M56201CLS-1	9D24BW	9F2900-03A	9F2900-07A	9F2900-08A	9F2900-04A	CTL12004RSPDDOE
56007HPDOE	9B5600-7HP	9M5600-7HP	9D24BW	9F2900-03A	9F2900-07A	9F2900-08A	9F2900-04A	27708
56007HPDOE-K	9B5600-7HP	9M5600-7HP	9D24BW	9F2900-03A	9F2900-07A	9F2900-08A	9F2900-04A	27708
60001HPDOE	9B6000-1HP	9M6000-1HP	9D24BW	9F2900-03A	9F2900-07A	9F2900-08A	9F2900-04A	12003
60001HPDOE-BRN	9B6000-1HPB		9D24BB	9F2900-03A	9FP029	9FP030	9F2900-04A	12003
60001HPDOE-K	9B6000-1HP	9M6000-1HP	9D24BW	9F2900-03A	9F2900-07A	9F2900-08A	9F2900-04A	12003
60001HPDOEBRN-K	9B6000-1HPB		9D24BB	9F2900-03A	9FP029	9FP030	9F2900-04A	12003
36201DOE	9B3620-1C	9M3620-1C	9D24BB	9F2900-03A	9F2900-07A	9F2900-08A	9F2900-04A	CTL12004RSPDDOE
36201DOE-K	9B3620-1C	9M3620-1C	9D24BB	9F2900-03A	9F2900-07A	9F2900-08A	9F2900-04A	CTL12004RSPDDOE
48201DOE	9B48201-1C	9M48201-1C	9D24BB	9F2900-03A	9F2900-07A	9F2900-08A	9F2900-04A	CTL12004RSPDDOE
48201DOE-K	9B48201-1C	9M48201-1C	9D24BB	9F2900-03A	9F2900-07A	9F2900-08A	9F2900-04A	CTL12004RSPDDOE

<b>J HOOK KIT</b>	<b>MODELS ENDING IN K COME WITH SPEED CONTROL</b>		
	<b>VARIABLE SP. CONTROL</b>	<b>VOLTS</b>	<b>AMPS</b>
	12003	120	3
	12006	120	6
	12008	120	8
	12012	120	12
	27708	277	8
<b>9F2900-01</b>			
<b>ALL MODELS</b>			
	<b>NOISELESS SP. CONTROL</b>		
	12001N	120	1
	12005N	120	5
	<b>REVERSING SP. CONTROL</b>		
	CTL12004RSPDDOE	120	4

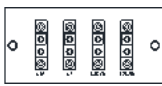

<b>MCSSAR SERIES (OBSOLETE)</b>					
<b>KNOB</b>	<b>PLUG BUTTON</b>	<b>MANUAL RESET</b>	<b>THERMAL FUSE</b>	<b>FAN BLADE</b>	<b>THERMOSTAT</b>
					
<b>3301-11013-000</b> ALL MODELS	<b>4506-2012-009</b> ALL MODELS	<b>4520-11019-000</b> ALL MODELS	<b>4520-2030-000</b> ALL MODELS	<b>490030103</b> ALL MODELS	<b>5813-2027-001</b> ALL MODELS
<b>FAN DELAY</b>			<b>LIGHT</b>		
					
<b>1414-2039-000</b> MCARWH1802 MCARWH1802AL MCARWH1802BZ MCARWH1802W	<b>410074000</b> MCARWH4804 MCARWH4804AL MCARWH4804BZ MCARWH4804W MCARWH4807 MCARWH4807AL MCARWH4807BZ MCARWH4807W		<b>3510-2017-000</b> MCARWH1802 MCARWH1802AL MCARWH1802BZ MCARWH1802W	<b>3510-2017-001</b> MCARWH4804 MCARWH4804AL MCARWH4804BZ MCARWH4804W MCARWH4807 MCARWH4807AL MCARWH4807BZ MCARWH4807W	
<b>MOTOR</b>			<b>ELEMENT</b>		<b>DISCONNECT SWITCH</b>
					
<b>3900-2010-003</b> MCARWH1802 MCARWH1802AL MCARWH1802BZ MCARWH1802W	<b>3900-2010-000</b> MCARWH4804 MCARWH4804AL MCARWH4804BZ MCARWH4804W MCARWH4808 MCARWH4808AL MCARWH4808BZ MCARWH4808W	<b>3900-2010-001</b> MCARWH4807 MCARWH4807AL MCARWH4807BZ MCARWH4807W	<b>302012828</b> MCARWH1802 MCARWH1802AL MCARWH1802BZ MCARWH1802W <b>302012811</b> MCARWH4807 MCARWH4807AL MCARWH4807BZ MCARWH4807W	<b>302012810</b> MCARWH4804 MCARWH4804AL MCARWH4804BZ MCARWH4804W <b>302012807</b> MCARWH4808 MCARWH4808AL MCARWH4808BZ MCARWH4808W	<b>410170001</b> ALL MODELS 

QFG-SERIES									
KNOB	GRILLE	BLOWER ASM				CLIP N FIT BOARD		THERMOSTAT	
									
<b>3301-2040-001</b> G1512T2M G2024T2M G1512T2MA G2024T2MA G2224T2MA G1512T2MB G2024T2MB G2224T2MB G1512T2MC G2024T2MC G2224T2MC	<b>2501-2046-000</b> ALL MODELS	<b>1225-2002-000</b> G1012IF G1512IF G1512M G1512T2M G1512IFMA G1512MA G1512T2MA G1512IFMB G1512MB G1512T2MB G1512IFMC G1512T2MC	<b>1225-2002-001</b> G1024IF G1524IF G2024IF G2024M G2024T2M G2028IF G2224IF G2024IFMA G2024MA G2024T2MA G2028IFA G2224IFMA G2224MA	G2224T2MA G2024IFMB G2224T2MB G2024MB G2024T2MB G2028IFB G2024IFMC G2224T2MC G2228IFC	<b>1249-2005-000</b> G1512M G1512T2M G2024M G2024T2M G2224M G1512MA G1512T2MA G2024IFMA G2024MA G2024T2MA G2224IFMA G2224MA G2224T2MA G1512IFMB	G1512MB G1512T2MB G2024IFMB G2024MB G2024T2MB G2224IFMB G2224T2MB G2228IFB G1512IFMC G1512T2MC G2024IFMC G2024T2MC G2224IFC G2224T2MC G2228IFC	<b>410130001</b> G1512T2M G1512T2MA G1512T2MB G2024T2M G2024T2MA G2224T2MA G2024T2MB G2224T2MB G1512T2MC G2024T2MC G2224T2MC		
<b>ELEMENT</b> 		<b>HI LIMIT</b> 				<b>LIGHT</b> 			
<b>1802-2124-005</b> G1024IF G2024IF	<b>1802-2124-000</b> G1512IF G1512IFMA	<b>4520-11012-000</b> G1512IFMC G1512T2MC	<b>4520-11012-001</b> G2024IFMC G2024T2MC G2224IFC G2224T2MC G2228IFC	<b>4520-2059-000</b> G1012IF G1512IF G1512M G1512T2M G1512IFMA G1512MA G1512T2MA G1512IFMB G1512MB G1512T2MB G1024IF G1524IF G2024IF G2024M G2024T2M G2224IFMB G2224T2MB		<b>3510-2017-000</b> G1012IF G1512IF G1512M G1512T2M G1512IFMA G1512MA G1512T2MA G1512IFMB G1512MB G1512T2MB G1512IFMC G1512T2MC	<b>3510-2017-001</b> G1024IF G1524IF G2024IF G2024M G2024T2M G2028IF G2224IF G2224M G2024IFMA G2024MA G2024T2MA G2028IFA G2224IFMA G2224T2MA G2224IFC G2224T2MC G2228IFC		
<del>1802-2124-001</del> G2028IFB	<b>1802-2125-001</b> G2224IFMB G2224T2MB G2224IFC G2224T2MC			G2028IF G2224IF G2224M G2024IFMA G2024MA G2024T2MA G2028IFA G2224IFMA G2224T2MA G2024IFMB G2024MA G2024T2MB G2028IFB G2224IFC G2224T2MC G2228IFC		G2024IFMB G2024MB G2024T2MB G2028IFB G2224IFMB G2024IFMC G2024T2MC G2224IFC G2224T2MC G2228IFC			

EFQ-SERIES					
GRILLE	ELEMENTS (2 REQ)			MOTOR (2 REQ)	
					
2501-2027-000 ALL MODELS	302012819 Q6003	302012821 Q8003	302012809 Q6004 Q8007	3900-2010-000 Q6003 Q6004 Q60048 Q6006 Q6008 Q8003 Q8004 Q80048 Q8006 Q8008	3900-2010-001 Q6007 Q8007
	302012820 Q6006 Q8006	302012826 Q80048	302012806 Q6007		
	302012825 Q60048	302012808 Q6008 Q8004	302012807 Q8008		
THERMOSTAT	FAN BLADE (2 REQ)	DISCONNECT SW.	TERMINAL BOARD		
					
410168002 (2REQ.) Q6003 Q60048 Q6006 Q8003 Q80048 Q8006	5813-0023-000 Q6004 Q6007 Q6008 Q8004 Q8007 Q8008	490030103 ALL MODELS	5216-2025-000 ALL MODELS	5823-2002-000 ALL MODELS	
TRANSFORMER			FAN DELAY (2 REQ)	MANUAL LIMIT (2 REQ)	
					
490015017 Q6003 Q8003	490015022 Q60048 Q80048	490015013 Q6006 Q8006	410074000 ALL MODELS	4520-2027-000 ALL MODELS	



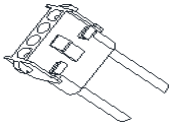
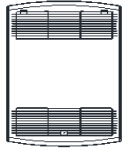
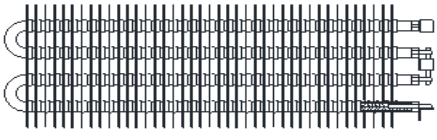
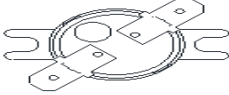









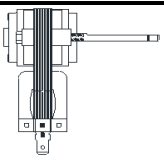
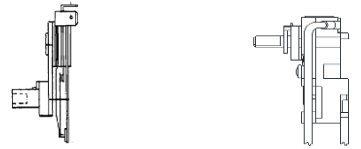



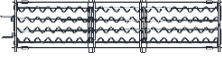

**ECP SERIES (OBSOLETE)**

PLUG ASSY FEMALE	GRILLE	ELEMENT		LIMIT
				
<p><b>1016-0114-000</b> ALL MODELS</p>	<p><b>2501-2082-000</b> ALL MODELS</p>	<p><b>302012808</b> ECP1024</p>	<p><b>302012803</b> ECP1524</p>	<p><b>4520-2025-001</b> ALL MODELS</p>
				









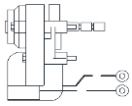
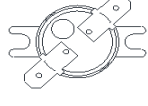

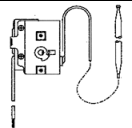

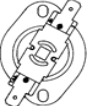

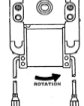

**AFA SERIES (OBS)**

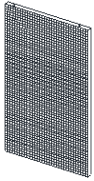

ELEMENTS					LIMIT			
								
<b>1802-2021-000</b>		<b>1802-2021-003</b>		<b>1802-2021-004</b>		<b>4520-2023-000</b>		
A1000IF	A1500IF	A1504IF	A1004IF	A2004T2B	A1000IF	A1500IFBNW	A2004IFB	
A1000IFA	A1500IFA	A1504IFA	A1004IFA	A2004T2BNW	A1000IFB	A1500T	A2004IFBNW	
A1000IFB	A1500IFB	A1504IFB	A1004IFB	A2404IF	A1000IFBNW	A1500T2B	A2004T	
A1000IFBNW	A1500IFBNW	A1504IFBNW	A1004IFBNW	A2404IFA	A1000T	A1500T2BNW	A2004T2B	
A1000T	A1500T	A1504T	A2004IF	A2404IFB	A1000T2B	A1504IF	A2004T2BNW	
A1000TA	A1500TA	A1504TA	A2004IFA	A2404IFBNW	A1000T2BNW	A1504IFB	A2404IF	
A1000T2	A1500T2	A1504T2	A2004IFB	A2404T	A1004IF	A1504IFBNW	A2404IFB	
A1000T2B	A1500T2B	A1504T2B	A2004IFBNW	A2404TA	A1004IFB	A1504T	A2404IFBNW	
A1000T2BNW	A1500T2BNW	A1504T2BNW	A2004T	A2404T2	A1004IFBNW	A1504T2B	A2404T	
			A2004TA	A2404T2B	A1500IF	A1504T2BNW	A2404T2B	
			A2004T2	A2404T2BNW	A1500IFB	A2004IF	A2404T2BNW	
MOTOR					THERMOSTAT			
								
<b>3900-2017-000</b>		<b>3900-2017-001</b>			<b>5813-2001-000</b>		<b>5813-2015-000</b>	
A0500IFA	A1000T2	A0504IFA	A1504IF	A2004TA	A0504TA	A0504T2	A1500T2BNW	
A0500IFB	A1000T2B	A0504IFB	A1504IFA	A2004T2	A1000T	A0504T2B	A1504T2B	
A0500IFBNW	A1000T2BNW	A0504IFBNW	A1504IFB	A2004T2B	A1000TA	A0504T2BNW	A1504T2BNW	
A0750IFA	A1500IF	A0504TA	A1504IFBNW	A2004T2BNW	A1500T	A1000T2	A2004T2	
A0750IFB	A1500IFA	A0504T2	A1504T	A2404IF	A1500TA	A1000T2B	A2004T2B	
A0750IFBNW	A1500IFB	A0504T2B	A1504TA	A2404IFA	A1504T	A1000T2BNW	A2004T2BNW	
A1000IF	A1500IFBNW	A0504T2BNW	A1504T2	A2404IFB	A1504TA	A1500T2	A2404T2B	
A1000IFA	A1500T	A0754IFA	A1504T2B	A2404IFBNW	A1504T2	A1500T2B	A2404T2BNW	
A1000IFB	A1500TA	A0754IFB	A1504T2BNW	A2404T	A2004T			
A1000IFBNW	A1500T2	A0754IFBNW	A2004IF	A2404TA	A2004TA			
A1000T	A1500T2B	A1004IF	A2004IFA	A2404T2	A2404T			
A1000TA	A1500T2BNW	A1004IFA	A2004IFB	A2404T2B	A2404TA			
		A1004IFB	A2004IFBNW	A2404T2BNW	A2404T2			
		A1004IFBNW	A2004T		A2404T2			

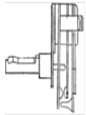
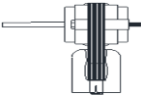





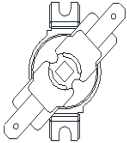
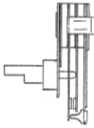
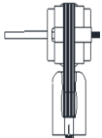



CRA SERIES									
KNOB		GRILLE	LIGHT				ELEMENT		
									
<b>3301-2039-002</b>		<b>2501-2065-000</b>	<b>3510-2017-000</b>	<b>3510-2017-001</b>	<b>3510-2017-002</b>	<b>3510-2017-003</b>	<b>1802-2124-005</b>	<b>1802-2124-000</b>	<b>1802-2124-003</b>
C1012T2	C1012T2AA	C1512FB	C1012IF	C1024IF	C1512IFAB	C1024IFAB	C1024IF	C1512IF	C1012IFA
C1024T2	C1512T2AA	C1512T2B	C1012T2	C1024T2	C1512T2AB	C1024T2AB	C1024T2	C1512T2	C1012T2A
C1512T2	C1012T2AB	C2024IFB	C1512IF	C1524IF	C1512IFB	C1524IFAB	C2024IF	C1512IFA	<del>1802-2124-001</del>
C1524T2	C1024T2AB	C2024T2B	C1512T2	C1524T2	C1512T2B	C1524T2AB	C2024T2	C1512T2A	C2028IFA
C2024T2	C1512T2AB	C2028IFB	C1012IFA	C2024IF	C1512IFC	C2024IFAB	C1024IFA	<b>1802-2124-002</b>	C2028T2A
C2028T2	C1524T2AB	C2224IFB	C1012T2A	C2024T2	C1512T2C	C2024T2AB	C1024T2A	C2224IFA	<b>1802-2127-000</b>
C2224T2	C2024T2AB	C2224T2B	C1512IFA	C2028IF	C2028T2	C2028IFAB	C2024IFA	C2224T2A	C1512IFB
C1012T2A	C2224T2AB	C1512IFC	C1512T2A	C2028T2	C1512IFC	C2224IFAB	C2024T2A	<b>1802-2127-005</b>	C1512T2B
C1024T2A	C1512T2B	C1512T2C	C1012IFAA	C2224IF	C2224T2C	C2224T2AB	<b>1802-2127-002</b>	C2024IFB	C1512IFC
C1512T2A	C2024T2B	C2024IFC	C1012T2AA	C2224T2	C1024T2A	C2024IFB	C2224IFB	C2024T2B	C1512T2C
C1524T2A	C2224T2B	C2024T2C	C1512IFAA	C1024IFA	C1524IFA	C1512T2A	C2024T2B	C2024IFC	<b>1802-2127-001</b>
C2024T2A	C1512T2C	C2028IFC	C1512T2AA	C1024T2A	C1524IFA	C2028IFB	C2224IFC	C2024T2C	C2028IFB
C2028T2A	C2024T2C	C2224IFC	C1012IFAB	C1524IFA	C2224IFB	C2224IFB	C2224T2C		C2028IFC
C2224T2A	C2224T2C	C2224T2C	C1012T2AB	C1524T2A	C2224T2B	C2024IFC	<b>MODELS NOT LISTED ARE OBSOLETE</b>		
				C2024IFA	C2024T2A	C2024T2C			
				C2028IFA	C2028T2A	C2224IFA			
				C2224T2A					
<b>FAN BLADE</b>	<b>MOTOR</b>		<b>HI LIMIT</b>			<b>CLIP N FIT BOARD</b>			
									
<b>1210-2008-000</b>	<b>3900-2017-000</b>	<b>3900-2017-001</b>	<b>3900-2035-000</b>	<b>4520-11007-000</b>	<b>4520-11007-001</b>	<b>4520-2059-000</b>	<b>1249-2005-000</b>		
ALL MODELS	C1012IF	C1024IF	C2028IF	C1512IFC	C2024IFC	C1012IF	C2024IF	C2224IFA	C1512IFB
	C1012T2	C1024T2	C2028T2	C1512T2C	C2024T2C	C1012T2	C2024T2	C2224T2A	C1512T2B
	C1512IF	C1524IF	C2224IF		C2028IFC	C1512IF	C1024IFA	C2028IFAB	C2024IFB
	C1512T2	C1524T2	C2224T2		C2224IFC	C1512T2	C1024T2A	C2224IFAB	C2024T2B
	C1012IFA	C2024IF	C2028IFA		C2224T2C	C1012IFA	C1524IFA	C2224T2AB	C2028IFB
	C1012T2A	C2024T2	C2028T2A			C1012T2A	C1524T2A	C2028IFB	C2224IFB
	C1512IFA	C1024IFA	C2224IFA			C1512IFA	C2024IFA	C2224IFB	C2224T2B
	C1512T2A	C1024T2A	C2224T2A			C1512T2A	C2024T2A	C2224T2B	C1512IFC
	C1012IFAA	C1524IFA	C2028IFAB			C1012IFAA	C1024IFAB		C1512T2C
	C1012T2AA	C1524T2A	C2224IFAB			C1012T2AA	C1024T2AB		C2024IFC
	C1512IFAA	C2024IFA	C2224T2AB			C1512IFAA	C1524IFAB		C2024T2C
	C1512T2AA	C2024T2A	C2028IFB			C1512T2AA	C1524T2AB		C2028IFB
	C1012IFAB	C1024IFAB	C2224IFB			C1012IFAB	C2024IFAB		C2224IFC
	C1012T2AB	C1024T2AB	C2224T2B			C1012T2AB	C2024T2AB		C2224T2C
	C1512IFAB	C1524IFAB	C2028IFC			C1512IFAB	C2024IFB		
	C1512T2AB	C1524T2AB	C2224IFC			C1512T2AB	C2024T2B		
	C1512IFB	C2024IFAB	C2224T2C			C1512IFB	C2028IF		
	C1512T2B	C2024T2AB				C1512T2B	C2028T2		
	C1512IFC	C2024IFB				C1024IF	C2224IF		
	C1512T2C	C2024T2B				C1024T2	C2224T2		
		C2024IFC				C1524IF	C2028IFA		
		C2024T2C				C1524T2	C2028T2A		
<b>THERMOSTAT</b>		<b>THERMAL FUSE</b>							
									
<b>410130001</b>	<b>5813-2090-000</b>	<b>4520-2030-000</b>							
C1012T2	C1012T2AB	C1012IFAA	C1512IFB						
C1512T2	C1512T2AB	C1012T2AA	C1512T2B						
C1012T2A	C1512T2B	C1512IFAA	C2024IFB						
C1512T2A	C1512T2C	C1512T2AA	C2024T2B						
C1012T2AA	C1024T2AB	C1012IFAB	C2028IFB						
C1512T2AA	C1524T2AB	C1012T2AB	C2224IFB						
C1024T2	C2024T2AB	C1512IFAB	C2224T2B						
C1524T2	C2024T2B	C1512T2AB	C1512IFC						
C2024T2	C2024T2C	C1024IFAB	C1512T2C						
C1024T2A	C2224T2AB	C1024T2AB	C2024IFC						
C1524T2A	C2224T2B	C1524IFAB	C2024T2C						
C2024T2A	C2224T2C	C1524T2AB	C2028IFC						
C2028T2		C2024IFAB	C2224IFC						
C2224T2		C2024T2AB	C2224T2C						
C2028T2A		C2024IFB							
C2224T2A		C2024T2B							
		C2028IFAB							
		C2224IFAB							
		C2224T2AB							

QVP					
MOTOR				LIMIT	
					
<b>42528-052-01</b>		<b>42528-052-02</b>		<b>4520-2025-000</b>	
VP1222	VP1222I	VP2022	VP2022I	VP1222C	VP2022IC
VP1222A	VP1222IB	VP2022A	VP2022IB	VP1222CNW	VP2022ICNW
VP1222AI	VP1222IBP	VP2022AI	VP2022IBP	VP1222IC	VP2422C
VP1222B	VP1222IC	VP2022B	VP2022IC	VP1222ICNW	VP2422CNW
VP1222C	VP1222ICNW	VP2022C	VP2022ICNW	VP2022C	VP2422IC
VP1222CNW		VP2022CNW		VP2022CNW	VP2422ICNW









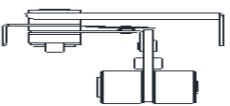

A2500					
THERMOSTAT	ELEMENT	LIMIT	THERMAL FUSE	GRILLE	MOTOR
				PICTURE NOT AVAILABLE	
<b>4230-8232</b>	<b>6101-8752</b>	<b>8541-8056</b>	<b>8671-8037</b>	<b>8683-8272</b>	<b>8767-8036</b>
A2515T	A2530T	A2515T	A2515T	A2515T	A2515T
A2520T		A2520T	A2520T	A2520T	A2520T
A2530T		A2530T	A2530T	A2530T	A2530T
A2540T		A2540T	A2540T	A2540T	A2540T
A2548T		A2548T	A2548T	A2548T	A2548T

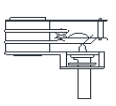
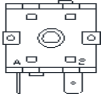
1235 & 2435 SERIES (OBS)					
SCREEN		KNOB	FACE PLATE	LIMIT	
					
<b>1235-0037</b> 1235 2435	<b>8850-8046</b> 1235P 2435P	<b>3301-2047-000</b> ALL MODELS	<b>4503-2094-000</b> ALL MODELS	<b>8541-8054</b> ALL MODELS	
THERMOSTAT	MOTOR	FAN BLADE	ELEMENT	THERMAL FUSE	
					
<b>1230-8194</b> ALL MODELS	<b>1235-0007</b> ALL MODELS	<b>1235-0008</b> ALL MODELS	<b>6101-8741</b> ALL MODELS	<b>8671-8036</b> 2435 2435P	

B2400 SERIES (OBS)			
ELEMENT		LIMIT	THERMOSTAT
			
<b>6101-8741</b> B2451	<b>6101-8742</b> B2452	<b>8541-8055</b> ALL MODELS	<b>1230-8206</b> ALL MODELS
MOTOR		FAN BLADE	THERMAL FUSE
			
<b>8767-8035</b> B2451	<b>8767-8036</b> B2452	<b>991-313</b> ALL MODELS	<b>8671-8037</b> B2452

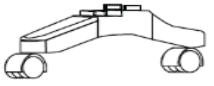

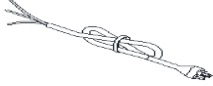









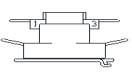

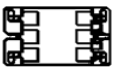

CWH2000								
ELEMENT							BLADE	
								
<b>302023801</b> CWH2101 CWH2101A CWH2101B CWH2101BWW CWH2101DS CWH2101DSB CWH2101DSBWW CWH2101DF	<b>302023802</b> CWH2151 CWH2151A CWH2151B CWH2151BWW CWH2151DS CWH2151DSB CWH2151DSBWW CWH2151DF	<b>302023803</b> CWH2157 CWH2157A CWH2157B CWH2157BWW CWH2157DSBWW CWH2157F	<b>302023804</b> CWH2208 CWH2208A CWH2208B CWH2208BWW CWH2208SBNW CWH2208F	<b>302023805</b> CWH2202 CWH2202A CWH2202B CWH2202BWW CWH2202DS CWH2202DSB CWH2202DSBWW CWH2202F	<b>302023806</b> CWH2207 CWH2207A CWH2207B CWH2207BWW CWH2207DS CWH2207DSB CWH2207DSBWW CWH2207F	<b>302023808</b> CWH2201 CWH2201A CWH2201B CWH2201BLT CWH2201BWW CWH2201DS CWH2201DSB CWH2201DSBWW CWH2201F	<b>490061001</b> ALL MODELS	
MOTOR				THERMOSTAT			KNOB	
								
<b>490062001</b> CWH2101 CWH2101A CWH2101B CWH2101BWW CWH2101DS CWH2101DSB CWH2101DSBWW CWH2101F CWH2151 CWH2151A CWH2151B CWH2151BWW CWH2151DS	CWH2151DSB CWH2151DSBWW CWH2151F CWH2201 CWH2201A CWH2201B CWH2201BLT CWH2201BWW CWH2201DS CWH2201DSB CWH2201DSBWW CWH2201F	<b>490062002</b> CWH2208 CWH2208A CWH2208B CWH2208BWW CWH2208SBNW CWH2208F	<b>490062003</b> CWH2202 CWH2202A CWH2202B CWH2202BWW CWH2202DS CWH2202DSB CWH2202DSBWW CWH2202F	<b>490062004</b> CWH22157 CWH22157A CWH22157B CWH22157BWW CWH22157F CWH2207 CWH2207A CWH2207B CWH2207BWW CWH2207DS CWH2207DSB CWH2207DSBWW CWH2207F	<b>5813-2001-000</b> CWH2101 CWH2101A CWH2101B CWH2101BWW CWH2101DS CWH2101DSB CWH2101DSBWW CWH2101F CWH2151 CWH2151A CWH2151B CWH2151BWW CWH2151DS CWH2151DSB CWH2151DSBWW CWH2151F CWH2157 CWH2157A CWH2157B CWH2157BWW CWH2157DSBWW CWH2157F		<b>5813-2022-000</b> CWH2201 CWH2201A CWH2201B CWH2201BWW CWH2201DS CWH2201DSB CWH2201DSBWW CWH2201F	<b>3301-2001-000</b> MODELS W/THERMOSTAT
FAN DELAY		LIMIT		MANUAL RESET	LIGHT		DISCONNECT SW	
								
<b>410074000</b> CWH2101 CWH2101B CWH2101BWW CWH2101DS CWH2101DSB CWH2101DSBWW CWH2101F CWH2151 CWH2151B CWH2151BWW CWH2151DS CWH2151DSB CWH2151DSBWW CWH2151F CWH2157 CWH2157B CWH2157BWW CWH2157DSBWW CWH2157F CWH2201 CWH2201B CWH2201BLT CWH2201BWW	CWH2201DSB CWH2201DSBWW CWH2201F CWH2202 CWH2202B CWH2202BWW CWH2202DSB CWH2202DSBWW CWH2202F CWH2207 CWH2207B CWH2207BWW CWH2207DSB CWH2207DSBWW CWH2207F	<b>1414-2009-000</b> CWH2101A CWH2101DS CWH2151A CWH2151DS CWH2157A CWH2201A CWH2201DS CWH2202A CWH2202DS CWH2207A CWH2207DS CWH208A	<b>410143000</b> CWH2101 CWH2101B CWH2101BWW CWH2101DSB CWH2101DSBWW CWH2101F CWH2151 CWH2151B CWH2151BWW CWH2151DSB CWH2151DSBWW CWH2151F CWH2157 CWH2157B CWH2157BWW CWH2157DSBWW CWH2201 CWH2201B CWH2201BLT CWH2201BWW	<b>4520-11016-000</b> CWH2101A CWH2101DS CWH2151A CWH2157A CWH2201A CWH2201DS CWH2202A CWH2202DS CWH2207A CWH2207DS CWH208A	<b>3510-2008-002</b> CWH2157B CWH2157BWW CWH2202B CWH2202BWW CWH2202DSB CWH2202DSBWW CWH2207B CWH2207BWW CWH2207DSB CWH2207DSBWW CWH2208B CWH2208BWW CWH2208DSBWW	<b>3510-2008-003</b> CWH2101B CWH2101BWW CWH2101DSB CWH2101DSBWW CWH2151B CWH2151BWW CWH2151DSB CWH2151DSBWW CWH2201B CWH2201BLT CWH2201BWW CWH2201DSB CWH2201DSBWW	<b>410170001</b> CWH2101DS CWH2101DSB CWH2101DSBWW CWH2151DS CWH2151DSB CWH2151DSBWW CWH2151F CWH2201DS CWH2201DSB CWH2201DSBWW CWH2202DS CWH2202DSB CWH2202DSBWW CWH2207DS CWH2207DSB CWH2207DSBWW CWH2208DSBWW	

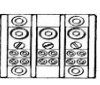
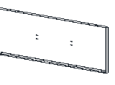
### WPC SERIES (OBS)

ELEMENT	TIP OVER SW.	LIMIT	THERMOSTAT
			
<b>1802-10822-000</b> WPC1500A <b>1802-11017-000 (500W)</b> <b>1802-11017-001 (1000W)</b> WPC1500B WPC1500C	<b>5216-11004-000</b> WPC1500A	<b>410122002</b> WPC1500A <b>4520-11004-003</b> WPC1500B WPC1500C	<b>5813-2092-001</b> WPC1500A WPC1500B WPC1500C
4 POSITION SW.	PORT SWITCH	LIGHT RED	PILOT LIGHT AMBER
			
<b>5216-2071-000</b> WPC1500A WPC1500B WPC1500C	<b>5216-2073-000</b> WPC1500A WPC1500B WPC1500C	<b>3510-2021-002</b> WPC1500A <b>3510-2021-004</b> WPC1500B WPC1500C	<b>3510-11518-000</b> WPC1500A WPC1500B WPC1500C
WHEEL KIT (2 REQ)	HOLE PLUG (2 REQ)	CORD	KNOB (2 REQ)
			
<b>1205-10305-000</b> WPC1500A WPC1500B WPC1500C	<b>4506-2022-000</b> WPC1500A WPC1500B WPC1500C	<b>1420-2029-009</b> WPC1500A WPC1500B WPC1500C	<b>3301-2058-000</b> WPC1500A WPC1500B WPC1500C

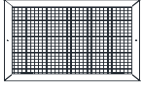

**TBX SERIES (OBS)**

ELEMENT	MOTOR	TIME DELAY RELAY	CONTACTOR 30AMP	CONTACTOR 50AMP	THERMOSTAT
					
302006814 TBX754	490059004 ALL MODELS	410171003 ALL MODELS	5018-0003-002 ALL MODELS	5018-0006-002 ALL MODELS	5813-2059-000 ALL MODELS
302006813 TBX104					
BLADE	HI LIMIT	TERMINAL BLOCK	TOOL BOX COVER	CORD	KNOB
					
490011001 ALL MODELS	410169001 ALL MODELS	480100001 ALL MODELS	<del>3016-0193-800</del> ALL MODELS	1016-10593-000 ALL MODELS	3301-2053-000 ALL MODELS
AXLE	GRILLE	COLLAPSABLE HANDLE	HANDLE	WHEEL (2 REQ)	AXLE CAP (2 REQ)
					
<del>3017-0004-000</del> ALL MODELS	<del>2501-10513-800</del> ALL MODELS	<del>2710-10586-000</del> ALL MODELS	2710-2012-800 ALL MODELS	6406-0002-000 ALL MODELS	<del>3408-10584-000</del> ALL MODELS



CU-A & CU-B OBSOLETE								
MODEL CU-B		PART NUMBER						
CABINET SERIES	FINTUBE HEATING ELEMENT (RETANGULAR ALUMINUM FIN)						FILTERS A & B MODELS	
	QTY.	208V	240V	277V & 480V 4-WIRE	480V 3-WIRE	THROWAWAY	REUSABLE	
1200	2							
1300	3							
1400	4	1802-0103-001	1802-0103-002	1802-0103-003	1802-0103-004	2010-7008-001	2010-7009-001	
1500	5							
1600	6							
2200	2							
2300	3							
2400	4	1802-0103-005	1802-0103-006	1802-0103-007	1802-0103-008	2010-7008-002	2010-7009-002	
2500	5							
2600	6							
3200	2							
3300	3							
3400	4	1802-0103-009	-	1802-0103-011	1802-0103-012	2010-7008-003	2010-7009-003	
3500	5							
3600	6							
4200	2							
4300	3							
4400	4	-	1802-0103-014	-	1802-0103-016	2010-7008-004	2010-7009-004	
4500	5							
4600	6							
5200	2							
5300	3							
5400	4	-	-	-	-	2010-7008-005	2010-7009-005	
5500	5							
5600	6							

MODELS CU-A & CU-B							
CABINET SERIES	PART NUMBER						
	BLOWER WHEEL	SHAFT	BEARINGS (2 EA)	COUPLING	FAN MOTOR	HIGH LIMIT	
						ALL EXCEPT CUI	CUI MODELS ONLY
1200-1600	6406-7001-001	-	-	-	3900-0558-000	4520-0011-007	-
2200-2600	6406-7001-001	-	-	-	3900-0559-000	4520-0011-007	-
3200-3600	6406-7001-002	5217-7007-001	2011-7017-000	1410-7003-001	3900-0563-000	-	4520-0011-009
4200-4600	6406-7001-002	5217-7007-002	2011-7017-000	1410-7003-001	3900-0563-000	-	4520-0011-009
5200-5600	6406-7001-002	5217-7007-003	2011-7017-000	1410-7003-001	3900-0563-000	-	4520-0011-009

PARTS COMMON TO ALL MODELS			CIRCUIT BREAKERS			
DESCRIPTION	PART NUMBER	VOLTAGE RATING	NUMBER OF POLES	AMPS	PART NUMBERS	
FAN RELAY:				15	4520-7009-014	
24V	CUBFDRK24			20	4520-7009-015	
120V	CUBFDRK120			25	4520-7009-016	
240V	CUBFDRK240			30	4520-7009-017	
SELECTOR SWITCH	5216-0302-000		2	35	4520-7009-018	
THERMOSTAT	-			40	4520-7009-019	
STEP-DOWN TRANSFORMER	5814-7013-003			45	4520-7009-020	
BUCK-BOOST TRANSFORMER	490015007			50	4520-7009-021	
SUMMER FAN SWITCH	5216-0302-000			60	4520-7009-022	
*CONTACTORS, CU-B		240V		15	4520-7009-008	
2 POLE/30 AMP, 24V HOLDING COIL	5018-0003-000			20	4520-7009-004	
2 POLE/30 AMP, 120V HOLDING COIL	5018-0003-001			25	4520-7009-010	
2 POLE/30 AMP, 208V/240V HOLDING COIL	5018-0003-002			30	4520-7009-005	
3 POLE/ 35 AMP, 24V HOLDING COIL	5018-0005-004		3	35	4520-7009-011	
3 POLE/ 35 AMP, 120V HOLDING COIL	5018-0005-005			40	4520-7009-006	
3 POLE/ 35 AMP, 208V/240V HOLDING COIL	5018-0005-006			45	4520-7009-012	
*CONTACTORS, CU-A				50	4520-7009-001	
2 POLE/30 AMP, 24V HOLDING COIL	5018-0004-100			60	4520-7009-007	
2 POLE/30 AMP, 120V HOLDING COIL	5018-0004-101			15	4520-7008-013	
2 POLE/30 AMP, 208V/240V HOLDING COIL	5018-0004-102			20	4520-7008-014	
3 POLE/ 50 AMP, 24V HOLDING COIL	5018-0006-000		2	25	4520-7008-015	
3 POLE/ 50 AMP, 120V HOLDING COIL	5018-0006-001			30	4520-7008-016	
3 POLE/ 50 AMP, 208V/240V HOLDING COIL	5018-0006-002			35	4520-7008-017	
* SEE INSTALLATION INSTRUCTIONS FOR SELECTION CHART OR CONSULT FACTORY		480V		40	4520-7008-018	
				50	4520-7008-020	
				60	4520-7008-021	
				15	4520-7008-005	
				20	4520-7008-006	
			3	25	4520-7008-008	
				30	4520-7008-001	
				35	4520-7008-009	
				40	4520-7008-007	

## Reference Data

### HOW TO ORDER

#### RATING SERIES PRODUCT NUMBERS

The last group of four numbers describe the Unit Size, Heating Capacity Voltage Rating and Type of Control:

Number of Fans and Cabinet Series are indicated by the first number.

- 1 - One Fan Series 1000 Cabinet
- 2 - Two Fans Series 2000 Cabinet
- 3 - Three Fans Series 3000 Cabinet
- 4 - Four Fans Series 4000 Cabinet
- 5 - Five Fans Series 5000 Cabinet

Number of Fintube Heating Elements and the corresponding Unit Heating Capacity are indicated by the second number.

	Cabinet Series			
	1000	2000	3000	4000
2 Element	2.0kW	4.0kW	5.3kW	6.7kW
3 Element	3.0kW	6.0kW	8.0kW	10.0kW
4 Element	4.0kW	8.0kW	10.7kW	13.3kW
5 Element	5.0kW	10.0kW	13.3kW	16.0kW*
6 Element	6.0kW	12.0kW	16.0kW	20.0kW*

Not available in all voltages. See table on page 2.

Electric Power Supply for the heating circuit is indicated by the third number as follows:

- 1 - 208V Single Phase
- 2 - 208V Three Phase
- 3 - 240V Single Phase
- 4 - 240V Three Phase
- 5 - 277V Single Phase
- 6 - 480V Three Phase 4 Wire
- 7 - 480V Three Phase 3 Wire
- 8 - 347V Single Phase
- 9 - 600V Three Phase

Control Supply and Circuit are defined by the fourth number.

NOTE: A thermostat either integral or remote, must be used for proper operation of heater.

Thermostat	Voltage	Supply	For Use Only With Models
0-	Integral	120	External CUC, CUF, CUW
1-	Integral	24	External CUC, CUF, CUW
2-	Integral	208/240*	Internal CUC, CUF, CUW
3-	Remote	120	External All Models
4-	Remote	24	External All Models
5-	Remote	208/240*	Internal All Models
6-	Remote	24	Internal All Models
7-	Remote	120	Internal All Models
8-	Integral	24	Internal CUC, CUF, CUW
9-	Integral	120	Internal CUC, CUF, CUW

\*Control Voltage is 208 VAC on units with 208 VAC Heating Circuit.

### MODEL LETTER



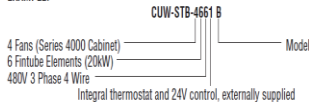

The letter "B" at the end of the catalog number designates the unit as a "B" model.

### EXAMPLE:





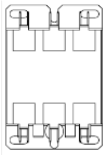
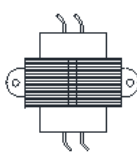

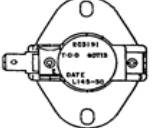
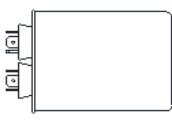





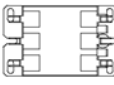
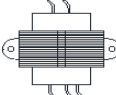





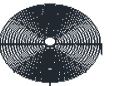
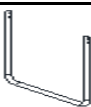





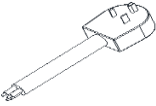

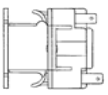
**DUH & DUH-A**

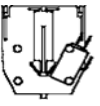
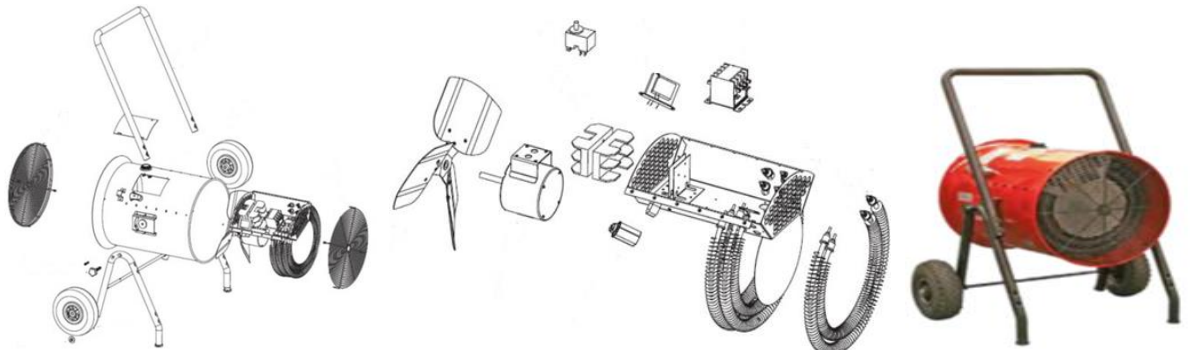
DUH & DUH-A				
BLADE	RELAY		TRANSFORMER	
				
<b>490020000</b>	<b>5018-0005-006</b>		<b>5018-0006-002</b>	<b>490015018</b>
H2520	H1020A	H1048A	H2520	H1034A
H2524	H1024A	H1555A	H2524	H1534A
H2548	H1027A	H1560A	H2548	<b>490015019</b>
H2555	H1034A	H2020	H2555	H2034
H2560	H1048A	H2024	H3020	<b>490015021</b>
H3020	H1055A	H2027	H3024	H1060A
H3024	H1060A	H2034	H3048	H1560A
H3048	H1520A	H2048	H3055	<b>490015005</b>
H3055	H1524A	H2055	H4020	H2027
H3060	H1527A	H2060	H4024	<b>490015008</b>
H4020	H1534A		H4048	H5048
H4024			H4055	H5055
H4048			H5020	<b>490015012</b>
H4055			H5024	H2060
H4060			H5060	H2560
				H3060
				H4060
				<b>490015015</b>
				H5060
LIMIT	FAN DELAY	CAPACITOR		
				
<b>410029000</b>	<b>410126000</b>	<b>1432-0002-003</b>		
ALL MODELS	ALL MODELS	ALL MODELS		

**MEDH SERIES**

ELEMENT SMALL		ELEMENT LARGE		MOTOR		CONTACTOR		TRANSFORMER			
											
<b>1802-11001-000</b> DH1583A DH1583B DH1583C		<b>1802-11001-001</b> DH1583A DH1583B DH1583C		<b>3900-11002-000</b> DH1021A DH1021CKA DH1021CKB DH1021CKC		<b>5018-0006-000</b> DH1543A DH1543B DH1543C DH3043A DH3043B DH3043C		<b>5018-0006-004</b> DH1021A DH1021CKA DH1021CKB DH1521A DH1521B DH1521C DH1523A DH1523B DH1523C DH1583A DH1583B DH1583C		<b>5814-0003-002</b> DH1543A DH1543B DH1543C DH3043A DH3043B DH3043C	
<b>1802-11001-002</b> DH1021A DH1021CKA DH1021CKB DH1021CKC DH1521A DH1521B DH1521C DH1523A DH1523B DH1523C DH1543A DH1543B DH1543C DH3043A DH3043B DH3043C		<b>1802-11001-003</b> DH1021A DH1021CKA DH1021CKB DH1021CKC DH1521A DH1521B DH1521C DH1523A DH1523B DH1523C DH1543A DH1543B DH1543C DH3043A DH3043B DH3043C		DH1521A DH1521B DH1521C DH1523A DH1523B DH1523C DH1583A DH1583B DH1583C DH1543C		<b>5018-0006-002</b> DH1021CKC					
<b>FAN BLADE</b>		<b>HI LIMIT</b>		<b>THERMOSTAT</b>		<b>CAPACITOR</b>		<b>GUARD REAR</b>		<b>GUARD FRONT</b>	
											
<b>1210-0098-001</b> ALL MODELS		<b>410029000</b> ALL MODELS		<b>5813-2059-000</b> ALL MODELS		<b>1432-0002-003</b> ALL MODELS		<b>2504-11004-000</b> ALL MODELS		<b>2504-11005-000</b> ALL MODELS	
<b>HANDLE</b>		<b>CART KNOB</b>		<b>THERMOSTAT KNOB</b>		<b>WHEEL</b>		<b>SHAFT CAP</b>		<b>AXEL SHAFT</b>	
											
<b>2710-11001-000</b> ALL MODELS		<b>3301-11003-000</b> ALL MODELS		<b>3301-11018-002</b> ALL MODELS		<b>6406-11001-000</b> ALL MODELS		<b>1408-11002-000</b> ALL MODELS		<b>5217-11001-000</b> ALL MODELS	
<b>CORD</b>		<b>FUSE</b>		<b>FUSE BLOCK</b>		<b>FAN RELAY</b>		<b>FAN DELAY</b>		<b>AUXILIARY SWITCH</b>	
											
<b>1016-10593-000</b> DH1021CKA DH1021CKB <b>SCS10063</b> DH1021CKC		<b>2019-7008-077</b> DH1521A DH1521B DH1521C		<b>480030007</b> DH1521A DH1521B DH1521C		<b>5018-0007-000</b> DH1543A DH1543B DH1543C DH3043A DH3043B DH3043C		<b>1414-2039-000</b> DH3043C		<b>5216-10564-000</b> DH1521C DH1543A DH1543B DH1543C DH3043A DH3043B DH3043C	
											

KD/KS			
UNIT SIZE	PART NUMBER		
	208V	240V	277V
ELEMENTS (AFTER 1993) (250 WATTS/FT. - SEE NOTE 1)			
24" CABINET	1802-2016-001	1802-2016-003	1802-2016-003
36" CABINET	1802-2016-009	1802-2016-010	1802-2016-011
48" CABINET	-	1802-2016-024	1802-2016-024
REPAIR PARTS (AFTER 1993)			
DISCRIPTION		PART NUMBER	
SPOT HIGH LIMIT		410027000	
OPT. THERMOSTAT, 1-POLE		410112000	
OPT. THERMOSTAT, 2-POLE		410113000	
OPTIONAL RELAY ( PRIOR TO 1993) (SEE NOTE 2)			
IDENTIFICATION NUMBER ON RELAY		PART NUMBER	
134-60103-301 (24V)		<del>5018-2006-000</del>	
134-60203-301 (120V)		5018-2021-001	
134-60303-301 (208V/240V)		5018-2006-002	
134-62303-301 (277V)		5018-2006-003	
NOTE 1: 500W/FT. UNITS REQUIRE 2 ELEMENTS. 750W/FT. UNITS REQUIRE 3 ELEMENTS. 1000W/FT. UNITS REQUIRE 4 ELEMENTS.			
NOTE 2: WITH SUFFIX "R" ADDED TO CATALOG NUMBER.			

QDB SERIES				
				
DISCRIPTION	PART NUMBERS			
	120V	208V	240V	277V
*ELEMENT (100 WATTS/FT)				
38"	1802-2016-014	1802-2016-006	1802-2016-007	1802-2016-015
50"	1802-2016-016	1802-2016-017	1802-2016-018	1802-2016-019
62"	1802-2016-026	1802-2016-027	1802-2016-028	1802-2016-029
*ELEMENT (188 WATTS/FT)				
38"	1802-2016-012	1802-2016-010	1802-2016-011	1802-2016-013
50"	1802-2016-020	1802-2016-024	1802-2016-025	1802-2016-021
62"	1802-2016-030	1802-2016-034	1802-2016-035	1802-2016-031
				
LINEAR LIMIT	TERMINAL BOX COVER		ELEMENT HANGER CLIP	
38"	410122003	<del>310527001</del>	402020000	
50"	410122004			
62"	410122005			

ADB, APH, & ASH SERIES



DISCRPTION	PART NUMBERS					
	120V	208V	240V	277V	347V	600V
<b>*ELEMENT (125 WATTS/FT)</b>						
<b>28" HEATER</b>						
3'	1802-2001-085	1802-2001-086	1802-2001-048	1802-2001-049	NA	NA
4'	1802-2001-087	1802-2001-088	1802-2001-054	1802-2001-055	1802-2001-220	NA
5'	1802-2001-089	1802-2001-090	1802-2001-060	1802-2001-061	1802-2001-230	NA
6'	1802-2001-091	1802-2001-092	1802-2001-066	1802-2001-067	1802-2001-240	1802-2001-241
8'	1802-2001-093	1802-2001-094	1802-2001-072	1802-2001-073	1802-2001-250	1802-2001-251
10'	NA	1802-2001-095	1802-2001-077	1802-2001-078	1802-2001-260	1802-2001-261
		1802-2001-096	1802-2001-081	1802-2001-082	1802-2001-270	1802-2001-271
<b>*ELEMENT (188 WATTS/FT)</b>						
<b>28" HEATER</b>						
3'	1802-2001-005	1802-2001-002	1802-2001-001	1802-2001-000	NA	NA
4'	1802-2001-011	1802-2001-008	1802-2001-007	1802-2001-006	1802-2001-216	NA
5'	1802-2001-017	1802-2001-014	1802-2001-013	1802-2001-012	1802-2001-226	1802-2001-227
6'	1802-2001-023	1802-2001-020	1802-2001-019	1802-2001-018	1802-2001-236	1802-2001-237
8'	1802-2001-029	1802-2001-026	1802-2001-025	1802-2001-024	1802-2001-246	1802-2001-247
10'	NA	1802-2001-032	1802-2001-031	1802-2001-030	1802-2001-256	1802-2001-257
	NA	1802-2001-036	1802-2001-035	1802-2001-034	1802-2001-266	1802-2001-267
<b>*ELEMENT (250 WATTS/FT)</b>						
<b>28" HEATER</b>						
3'	1802-2001-004	1802-2001-003	1802-2001-002	1802-2001-001	1802-2001-202	NA
4'	1802-2001-010	1802-2001-009	1802-2001-008	1802-2001-007	1802-2001-214	NA
5'	1802-2001-016	1802-2001-015	1802-2001-014	1802-2001-013	1802-2001-224	1802-2001-225
6'	1802-2001-022	1802-2001-021	1802-2001-020	1802-2001-019	1802-2001-234	1802-2001-235
8'	1802-2001-028	1802-2001-027	1802-2001-026	1802-2001-025	1802-2001-244	1802-2001-245
10'	NA	1802-2001-033	1802-2001-032	1802-2001-031	1802-2001-254	1802-2001-255
	NA	1802-2001-037	1802-2001-036	1802-2001-035	1802-2001-264	1802-2001-265

\* 1.2 OR 3 ELEMENTS MAY BE REQUIRED. VOLTAGE AND WATTAGE ARE STAMPED ON END OF ELEMENTS. DIVIDE THE WATTAGE BY THE HEATER LENGTH (FEET) TO DETERMINE WATTS/FOOT OF ELEMENT. THEN USE THIS DATA TO DETERMINE PART NUMBER OF HEATING ELEMENT.



DISCRPTION	PART NUMBERS					
	120V	208V	240V	277V	347V	600V
<b>LINEAR LIMIT</b>						
<b>28" HEATER</b>						
3'	4520-0007-007	4520-0007-007	4520-0007-007	4520-0007-007	4520-0007-007	4520-0007-007
4'	4520-0007-008	4520-0007-008	4520-0007-008	4520-0007-008	4520-0007-008	4520-0007-008
5'	4520-0007-009	4520-0007-009	4520-0007-009	4520-0007-009	4520-0007-009	4520-0007-009
6'	4520-0007-010	4520-0007-010	4520-0007-010	4520-0007-010	4520-0007-010	4520-0007-010
8'	4520-0007-011	4520-0007-011	4520-0007-011	4520-0007-011	4520-0007-011	4520-0007-011
10'	NA	4520-0007-012	4520-0007-012	4520-0007-012	4520-0007-012	4520-0007-012
	NA	4520-0007-013	4520-0007-013	4520-0007-013	4520-0007-013	4520-0007-013

DISCONNECT SW.	THERMOSTAT	TRANSFORMER RELAY	24V TRANSFORMER	PNEUMATIC CONTROL
410170001	<b>2-STAGE</b> 5813-0023-000 <b>SINGLE POLE</b> 5813-0024-000	<b>120V</b> 5018-11003-000 <b>208/240V</b> 5018-11003-001	<b>277V</b> 5018-11003-002 <b>347V</b> 5018-11003-003	<b>208/240V PRIMARY</b> 490026001 <b>277V PRIMARY</b> 490026002
				<b>ALL MODELS</b> 5216-7027-005

CIRCUIT BREAKER	POWER RELAY	
<b>2-POLE, 30A</b> 1226-7009-013 <b>2-POLE, 60A</b> 1226-7009-010 <b>3-POLE, 30A</b> 1226-7009-005 <b>3-POLE, 60A</b> 1226-7009-002	<b>24V</b> 5018-2017-001 <b>120V</b> 5018-2021-001 <b>208/240V</b> 5018-2021-002	<b>277V</b> 410171003



## ARL SERIES (OBS)

### ELEMENT

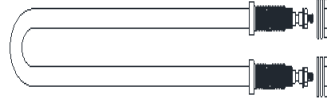

**1802-7076-001**  
L1511B

**1802-7076-008**  
L4521B

**HE45240**  
L4521

**1802-7076-003**  
L2021B

**1802-7076-010**  
L4541B

**HE45480**  
L4541

**1802-7076-005**  
L2041B

**1802-7076-011**  
L4561B

**HE20240**  
L6023

**1802-7076-006**  
L2061B

**1802-7076-009**  
L4571B

**HE20480**  
L6043

**1802-7076-004**  
L2071B

**1802-7076-007**  
L4581B

**HE45480**  
L13543

**1802-7076-002**  
L2081B

### RELECTOR

**891755004**  
L1511B

**891755002**  
L4581B  
L4541B  
L4521B



1.5KW Portable



4.5KW Portable















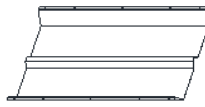

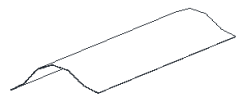
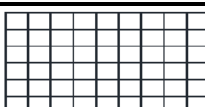
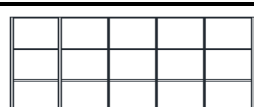

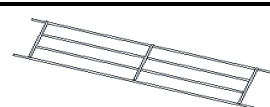

## CRN SERIES (OBS)

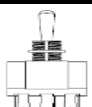
### ELEMENT



<b>1802-2115-001</b> N1011A	<b>1802-2115-013</b> N2001A	<b>1802-7077-001</b> N1011B	<b>1802-7077-009</b> N2001B
<b>1802-2115-004</b> N1021A	<b>1802-2115-015</b> N2021A	<b>1802-7077-003</b> N1021B	<b>1802-7077-010</b> N2021B
<b>1802-2115-006</b> N1031A	<b>1802-2115-017</b> N2031A	<b>1802-7077-002</b> N1081B	<b>1802-7077-012</b> N2031B
<b>1802-2115-005</b> N1071A	<b>1802-2115-016</b> N2071A	<b>1802-7077-004</b> N1511B	<b>1802-7077-011</b> N2071B
<b>1802-2115-008</b> N1501A	<b>1802-2115-018</b> N2501A	<b>1802-7077-006</b> N1521B	<b>1802-7077-013</b> N2501B
<b>1802-2115-007</b> N1511A	<b>1802-2115-020</b> N2521A	<b>1802-7077-008</b> N1531B	<b>1802-7077-014</b> N2521B
<b>1802-2115-010</b> N1521A	<b>1802-2115-022</b> N2531A	<b>1802-7077-007</b> N1571B	<b>1802-7077-016</b> N2531B
<b>1802-2115-012</b> N1531A	<b>1802-2115-021</b> N2571A	<b>1802-7077-005</b> N1581B	<b>1802-7077-015</b> N2571B
<b>1802-2115-011</b> N1571A			





<b>FRR &amp; CMRR SERIES (OBS)</b>			
<b>ELEMENT</b>			
			
1802-0070-509 RR22012A	1802-2113-501 RR41512A	1802-2119-500 RR10512A RR11012A	1802-2151-001 RR26164
1802-0070-550 RR35724A	1802-2113-516 RR53024A		1802-2151-000 RR26168
<b>REFLECTOR</b>			
			
5007-2013-000 RR41512A 5007-2013-001 RR53024A	5007-2020-000 RR22012A 5007-2020-001 RR35724A	5007-2021-000 RR10512A RR11012A	5007-2027-000 RR26164 RR26168
<b>WIRE GUARD</b>			
			
2504-2014-000 RR35724A	2504-2015-000 RR22012A	2504-2016-000 RR41512A 2504-2016-001 RR53024A 2504-2016-002 RR26164 RR26168	2504-2017-000 RR10512A RR11012A
<b>CERAMIC BLOCK</b>		<b>SWITCH</b>	
			
1224-0049-000 RR22012A RR26164 RR26168 RR35724A	1224-2006-000 RR10512A RR11012A	410024000 RR11012A	5216-11009-000 RR22012A RR35724A
<b>ELEMENT BUSHING</b>	<b>CORD</b>	<b>CHAIN 4"</b>	<b>"S" HOOKS</b>
			
1213-0070-000 RR22012A RR26164 RR26168 RR35724A	1420-2016-000 RR10512A RR41512A	1404-2000-001 RR10512A RR11012A RR22012A RR35724A RR41512A RR53024A	2706-2000-000 RR10512A RR11012A RR22012A RR35724A RR41512A RR53024A
	1420-2016-008 RR11012A		
	1420-2016-002 RR22012A		
	1420-2031-000 RR35724A		
	1420-2016-001 RR53024A		
			

RDO SERIES				
KEY NUMBER	DESCRIPTION	PART NUMBER		
		RDO26	RDO35	RDO48
1	REFLECTOR: 60/90 SYM	-	-	-
	30 DEGREES SYM	-	-	-
	60/90 ASYM	-	-	-
	30 DEGREES ASYM	-	-	-
2	INSULATOR	-	-	-
3	TERMINAL BLOCK (4 REQ)	1224-0049-000	1224-0049-000	1224-0049-000
4	ELEMENT TERM. BUSH. (4 REQ)	1213-0070-000	1213-0070-000	1213-0070-000
SOME ELEMENTS AVAILABLE-SEE FACTORY				
QRH SERIES				
ELEMENTS	RH16-91S-208	2QL16208		
	RH16-91S-240	2QL16240		
	RH16-91S-277	2QL16277		



**INDUSTRIAL CEILING FANS (FANS ARE PHASED OUT SOME PARTS MAY NOT BE AVAILABLE)**



**BLADE (SET)**

					
<b>9B3620-1</b> 36201	<b>9B4820-3</b> 48203	<b>9B5600-1</b> 56001	<b>9B6000-1</b> 60001	<b>9B5630-1R</b> 56301RDP	
<b>9B4820-1</b> 48201 48207	<b>9B5600-1LC</b> 56001LC 56101	56002 56003 56007	<b>9B6001-1</b> 60011		
<b>9B4820-1B</b> 48201B	56111	<b>9B5601-1</b> 56011	<del>9B6011-1</del> 60101 60111		
		<b>9B5600-1B</b> 56001B	<b>9B5620-1</b> 56201		

**DOWNROD 24"**

**DOWNROD 8"**

**MOTOR**

					
<b>9D24BW</b> 36201 48201 56001LC 56001 56002 56003 56007 56301RDP 48203 48207 60001 56201	<b>9D248BLK</b> 48201B 56001B <b>9D24BB</b> 56011 60011 <b>9D12TW</b> 56101 56111 60101 60111	<b>9D08</b> 36201 48201 56001LC 56003 48203 <b>9D08BBLK</b> 48201B	<b>9M3620-1-A</b> 36201 <del>9M4820-1-A</del> 48201 <b>9M4820-1B-A</b> 48201B <b>9M4820-3-A</b> 48203 <b>9M5600-7-A</b> 48207 <del>6011-1U</del> 60101 60111	<b>9M5600-1LC-A</b> 56001LC <del>9M5600-1-A</del> 56001 <b>9M5600-1B-A</b> 56001B <del>9M5600-4-A</del> 56002 <del>9M5600-3-A</del> 56003 <del>9M5600-7-A</del> 56007	<b>9M5601-1-A</b> 56011 <del>5611-1U</del> 56101 56111 <del>9M5630-1R-A</del> 56301RDP <del>9M6000-1-A</del> 60001 <b>9M6001-1-A</b> 60011 <del>9M5620-1-A</del> 56201

**RUBBER ROLLER**





**J HOOK KIT**

**BLADE SCREWS (6 REQ)**

**BLADE PADS (3 REQ)**

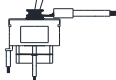

**REVERSIBLE TOGGLE**

**REVERSING SW. PLATE**

					
<b>9F2900-04A</b> ALL MODELS	<b>9F2900-01</b> ALL MODELS	<b>9F2900-20A</b> ALL MODELS	<b>9F2900-19A</b> ALL MODELS	<b>9F2GX54-73</b> 56301RDP	<b>9FP005</b> 56301RDP

**CANOPY UPPER**



**CANOPY LOWER**

					
<b>9F2900-07A</b> 36201 48201 56001LC 56001 56002 56003 56007 56301RDP 48203 48207 60001 56201	<b>9F2900-07AB</b> 48201B 56001B <b>9FP029</b> 56011 60011 <b>3100039A</b> 56101 56111 60101 60111	<b>9F2900-08A</b> 36201 48201 56001LC 56001 56002 56003 56007		<b>9F2900-08AB</b> 48201B 56001B <b>9FP030</b> 56011 60011	

**3-SPEED PULL CHAIN SW.**

**PULL CHAIN STRING**

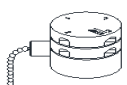
**OUTDOOR KIT**

		<b>PICTURE NOT AVAILABLE</b>
<b>9F2900-26</b> 48203 56003	<b>3378</b> 48203 56003	<b>99992</b> 56101 60101

