

This catalog contains part numbers for the most common replacement parts for Berko heaters shown in the Table of Contents. Additional parts for these heaters may be available - consult factory for availability. Parts for Berko heaters not listed in the Table of Contents may be available - consult factory for availability.

## TABLE OF CONTENTS

<b>BASEBOARD</b>	<b>UNIT HEATERS</b>	<b>RADIANT</b>
(2500 Series & BKOC)..... 2	CUH900 ..... 19	XRM ..... 38
Baseboard Accessories ..... 4	PHFP25 ..... 21	VRP & VRS ..... 39
HBB ..... 5	HUH ..... 22	JRK ..... 40
<b>WALL HEATERS</b>	BDH MODEL D..... 23	RCC ..... 41
SSARWH ..... 6	BSDH ..... 24	<b>PORTABLE</b>
SSHOWH ..... 7	BPH ..... 25	QPH4A ..... 29
HT ..... 8	HUHA AFC..... 26	FBE ..... 42
FRC (WH-FC) ..... 9	HUH524TA & HUH724ST ..... 28	LFP ..... 42
FRA (WHB3000) ..... 10	PH5 ..... 29	FHP ..... 43
SRA (WHB1000) ..... 11	BWD ..... 30	<b>INDUSTRIAL PRODUCTS</b>
SRA ARCHITECTURAL SERIES ..... 12	<b>CONNECTORS</b>	DOE CEILING FANS ..... 44
VFK ..... 13	UCJ ..... 31	
GFR ..... 14	ASL ..... 32	
SED ..... 15	BDBSL ..... 33	
COS-E ..... 16	ICST ..... 34	
<b>SPECIALTY HEATERS</b>	CSL ..... 35	
QTS ..... 17	CPL ..... 35	
FDI ..... 17	ASLC ..... 36	
WHT ..... 17	THX ..... 37	
<b>CEILING HEATERS</b>		
QCH ..... 18		
QFF ..... 18		
FFCH ..... 18		

## OBsolete PRODUCTS

SOME PARTS MAY NO LONGER BE AVAILABLE FOR OBSOLETE PRODUCTS

<b>WALL HEATERS</b>	<b>CEILING HEATERS</b>	<b>RADIANT</b>
MCSSAR ..... 45	SCH ..... 51	WRL ..... 65
QFG ..... 46	<b>UNIT HEATERS</b>	YRN ..... 66
MFQ ..... 47	TBX ..... 58	FFR ..... 67
ECP ..... 48	CUH ..... 59	PMRR ..... 67
MFA ..... 49	VUH ..... 59	RH ..... 68
CRA ..... 50	VUH-A ..... 59	<b>INDUSTRIAL PRODUCTS</b>
BVP ..... 51	HUHAA ..... 60	COMMERCIAL CEILING FANS ..... 69
A2500 ..... 51	BDH ..... 62	
1235 & 2435 ..... 52	<b>CONNECTORS</b>	
B2400 ..... 51	CC & DCC ..... 63	
SR ..... 53	DB ..... 63	
SRA ..... 54	<b>SPECIALTY HEATERS</b>	
FR ..... 55	CFWF ..... 17	
FRA ..... 56	<b>BASEBOARD</b>	
FRC ..... 57	OBD ..... 5	
	<b>PORTABLE</b>	
	WPC ..... 64	

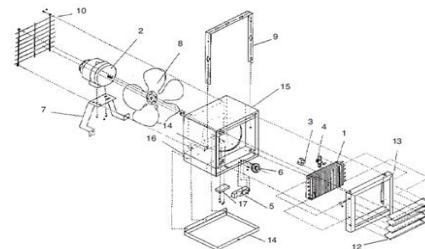

FOR SERVICE PARTS CONTACT CARROLL PARTS 800-654-3545

C2500 & 2500 SERIES

ELEMENTS



<b>1802-11021-008</b>	<b>1802-11021-009</b>	<b>1802-11021-010</b>	<b>1802-11021-011</b>	<b>1802-2044-014</b>	<b>1802-2044-015</b>
2573WCA	2543WCA	2503WCA	2513WCA	2574WCA	2544WCA
2573NWCA	2543NWCA	2503NWCA	2513NWCA	2574NWCA	2544NWCA
C2573WCA	C2543WCA	C2503WCA	C2513WCA	C2574WCA	C2544WCA
C2573NWCA	C2543NWCA	C2503NWCA	C2513NWCA	C2574NWCA	C2544NWCA
<b>1802-2044-026</b>	<b>1802-2094-017</b>	<b>1802-2044-028</b>	<b>1802-2094-015</b>	<b>1802-2044-016</b>	<b>1802-2044-017</b>
2576WCA	2546WCSA	2506WCA	2516WCSA	2504WCA	2514WCA
2576NWCA	2546NWCSA	2506NWCA	2516NWCSA	2504NWCA	2514NWCA
C2576WCA	C2546WCSA	C2506WCA	C2516WCSA	C2504WCA	C2514WCA
C2576NWCA	C2546NWCSA	C2506NWCA	C2516NWCSA	C2504NWCA	C2514NWCA
<b>1802-2044-020</b>	<b>1802-2044-021</b>	<b>1802-2044-022</b>	<b>1802-2044-023</b>	<b>1802-2094-000</b>	<b>1802-2094-001</b>
2575WCA	2545WCA	2505WCA	2515WCA	2508WCSA	2548WCSA
2575NWCA	2545NWCA	2505NWCA	2515NWCA	2508NWCSA	2548NWCSA
C2575WCA	C2545WCA	C2505WCA	C2515WCA	C2508WCSA	C2548WCSA
C2575NWCA	C2545NWCA	C2505NWCA	C2515NWCA	C2508NWCSA	C2548NWCSA
<b>1802-11021-000</b>	<b>1802-11021-001</b>	<b>1802-11021-002</b>	<b>1802-11021-003</b>	<b>1802-2094-002</b>	<b>1802-2094-003</b>
2572WCA	2542WCA	2502WCA	2512WCA	2578WCSA	25008WCSA
2572NWCA	2542NWCA	2502NWCA	2512NWCA	2578NWCSA	25008NWCSA
C2572WCA	C2542WCA	C2502WCA	C2512WCA	C2578WCSA	C25008WCSA
C2572NWCA	C2542NWCA	C2502NWCA	C2512NWCA	C2578NWCSA	C25008NWCSA
<b>1802-11021-004</b>	<b>1802-11021-005</b>	<b>1802-11021-006</b>	<b>1802-11021-007</b>	<b>1802-2094-004</b>	<b>1802-2094-005</b>
25726WCA	25426WCA	25026WCA	25126WCA	25408WCSA	25708WCSA
25726NWCA	25426NWCA	25026NWCA	25126NWCA	25408NWCSA	25708NWCSA
C25726WCA	C25426WCA	C25026WCA	C25126WCA	C25408WCSA	C25708WCSA
C25726NWCA	C25426NWCA	C25026NWCA	C25126NWCA	C25408NWCSA	C25708NWCSA

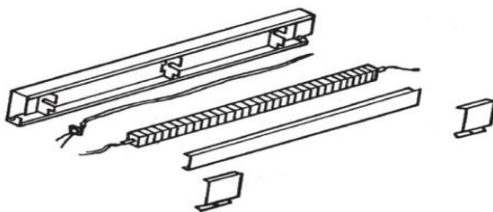



**C2500 & 2500 SERIES CONTINUED**

**FACE PLATE**



COLOR	FEET	GA.	PART NUMBER	COLOR	FEET	GA.	PART NUMBER
NAVAJO	2.5	18	1402-2122-040	NORTHERN WHITE	2.5	18	1402-2122-061
NAVAJO	3	18	1402-2122-041	NORTHERN WHITE	3	18	1402-2122-062
NAVAJO	4	18	1402-2122-042	NORTHERN WHITE	4	18	1402-2122-063
NAVAJO	5	18	1402-2122-043	NORTHERN WHITE	5	18	1402-2122-064
NAVAJO	6	18	1402-2122-044	NORTHERN WHITE	6	18	1402-2122-065
NAVAJO	8	18	1402-2122-045	NORTHERN WHITE	8	18	1402-2122-066
NAVAJO	2	22	1402-2122-635	NORTHERN WHITE	2	22	1402-2122-623
NAVAJO	2.5	22	1402-2122-628	NORTHERN WHITE	2.5	22	1402-2122-616
NAVAJO	3	22	1402-2122-629	NORTHERN WHITE	3	22	1402-2122-617
NAVAJO	4	22	1402-2122-630	NORTHERN WHITE	4	22	1402-2122-618
NAVAJO	5	22	1402-2122-631	NORTHERN WHITE	5	22	1402-2122-619
NAVAJO	6	22	1402-2122-632	NORTHERN WHITE	6	22	1402-2122-620
NAVAJO	8	22	1402-2122-633	NORTHERN WHITE	8	22	1402-2122-621

NOTE: 18GA IS FOR COMERCIAL MODELS

**CONTROL BOX COVER**











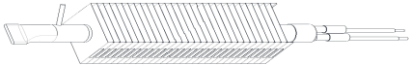

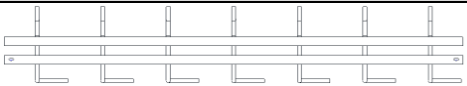
COLOR	GA.	PART NUMBER	COLOR	GA.	PART NUMBER
NAVAJO	24	1402-2261-601	NORTHERN WHITE	24	1402-2261-600
NAVAJO	20	1402-2261-603	NORTHERN WHITE	20	1402-2261-604









NOTE: 20 GA IS FOR COMERCIAL MODELS

**ACCESSORIES**

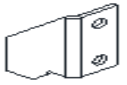
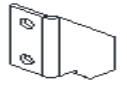

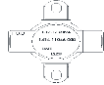
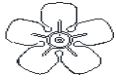
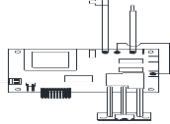

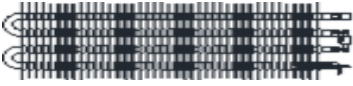
MODEL	KNOBS	THERMOSTATS
T1	3301-2011-000	5813-2014-000
T2	3301-2011-000	5813-2015-000
T1A	3301-2014-006	410127001
T2A	3301-2020-004	410128001
T4		410129001
T4A	3301-2014-006	410129001
T5A	3301-2020-004	410130001
TA1AW	42521-032-10	5813-2009-000
TA2AW	42521-032-08	5813-2010-000
TA1ANW	42521-032-11	5813-2009-000
TA2ANW	42521-032-09	5813-2010-000
TA1AWCA	42521-032-10	5813-2009-000
TA2AWCA	42521-032-08	5813-2010-000
TA1ANWCA	42521-032-11	5813-2009-000
TA2ANWCA	42521-032-09	5813-2010-000

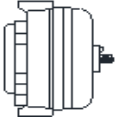
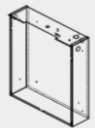
HBB SERIES BASEBOARD											
ELEMENT						LIMIT					
											
1802-2068-000	1802-2068-001	1802-2068-002	1802-2068-003	1802-2068-004	1802-2068-016	410122002	410122003	410122004	410122005	410122006	410122008
500D	7500D	1000D	1250D	1500D	2004D	500D	7500D	1000D	1250D	1500D	2004D
500DA	7500DA	1000DA	1250DA	1500DA	2004DA	500DA	7500DA	1000DA	1250DA	1500DA	2004DA
500DB	7500DB	1000DB	1250DB	1500DB	2004DB	500DB	7500DB	1000DB	1250DB	1500DB	2004DB
1802-2068-011	1802-2068-012	1802-2068-013	1802-2068-014	1802-2068-015	1802-2067-010	504D	7504D	1004D	1254D	1504D	2007D
504D	7504D	1004D	1254D	1504D	2008D	504DA	7504DA	1004DA	1254DA	1504DA	2007DA
504DA	7504DA	1004DA	1254DA	1504DA	2008DA	504DB	7504DB	1004DB	1254DB	1504DB	2007DB
504DB	7504DB	1004DB	1254DB	1504DB		508D	7507D	1007D	1257D	1507D	2008DB
1802-2068-005	1802-2068-006	1802-2068-007	1802-2068-008	1802-2068-009		508DA	7508D	1008D	1258D	1508D	
508D	7508D	1008D	1258D	1508D		508DA	7508DA	1008DA	1258DA	1508DA	
508DA	7508DA	1008DA	1258DA	1508DA		508DB	7508DB	1008DB	1258DB	1508DB	
508DB	7508DB	1008DB	1258DB	1508DB							
FRONT COVER						GRILLE					
											
1402-2066-000	1402-2066-001	1402-2066-002	1402-2066-003	1402-2066-004	1402-2066-005	2501-2012-012	2501-2012-013	2501-2012-014	2501-2012-015	2501-2012-010	2501-2012-011
500D	7500D	1000D	1250D	1500D	2004D	500D	7500D	1000D	1250D	1500D	2004D
500DA	7500DA	1000DA	1250DA	1500DA	2004DA	500DA	7500DA	1000DA	1250DA	1500DA	2004DA
500DB	7500DB	1000DB	1250DB	1500DB	2004DB	500DB	7500DB	1000DB	1250DB	1500DB	2004DB
504D	7504D	1004D	1254D	1504D	2007D	504D	7504D	1004D	1254D	1504D	2007D
504DA	7504DA	1004DA	1254DA	1504DA	2008D	504DA	7504DA	1004DA	1254DA	1504DA	2008D
504DB	7504DB	1004DB	1254DB	1504DB	2008DA	504DB	7504DB	1004DB	1254DB	1504DB	2008DA
508D	7507D	1007D	1257D	1507D	2008DB	508D	7507D	1007D	1257D	1507D	2008DB
508DA	7508D	1008D	1258D	1508D		508DA	7508D	1008D	1258D	1508D	
508DB	7508DA	1008DA	1258DA	1508DA		508DB	7508DA	1008DA	1258DA	1508DB	
508DB	7508DB	1008DB	1258DB	1508DB							
JUNCTION BOX COVER ALL MODELS 1800-2022-000											
											
OBD SERIES BASEBOARD (OBSOLETE)											
ELEMENT						LIMIT					
											
1802-2056-007	1802-2056-011	1802-2063-017	1802-2063-023	1802-2094-015	1802-2063-033	4520-2018-001	4520-2018-002	4520-2018-003	4520-2018-004	4520-2018-005	4520-2018-006
D500	D750	D1000	D1250	D1500	D2004	D500	D750	D1000	D1250	D1500	D2004
D500A	D750A	D1000A	D1250A	D1500A	D2004A	D500A	D750A	D1000A	D1250A	D1500A	D2004A
1802-2056-005	1802-2056-009	1802-2063-015	1802-2063-021	1802-2063-027	1802-2063-032	D504	D754	D1004	D1254	D1504	D2007
D504	D754	D1004	D1254	D1504	D2007	D504A	D754A	D1004A	D1254A	D1504A	D2007A
D504A	D754A	D1004A	D1254A	D1504A	D2007A	D507	D757	D1007	D1256	D1507	D2008
1802-2056-004	1802-2056-008	1802-2063-014	1802-2063-047	1802-2063-026	1802-2063-034	D507A	D757A	D1007A	D1256A	D1507A	D2008A
D507	D757	D1007	D1256	D1507	D2008	D507A	D757A	D1007A	D1256A	D1507A	D2008A
D507A	D757A	D1007A	D1256A	D1507A	D2008A	D508	D758	D1008	D1257	D1508	
1802-2056-006	1802-2056-010	1802-2063-016	1802-2063-020	1802-2063-028		D508A	D758A	D1008A	D1257A	D1508A	
D508	D758	D1008	D1257	D1508		D508A	D758A	D1008A	D1257A	D1508A	
D508A	D758A	D1008A	D1257A	D1508A							
			1802-2063-022								
			D1258								
			D1258A								
FRONT COVER						GRILLE					
											
1402-2066-010	1402-2066-011	1402-2066-012	1402-2066-013	1402-2066-014	1402-2066-015	2501-2012-012	2501-2012-013	2501-2012-014	2501-2012-015	2501-2012-010	2501-2012-011
D500	D750	D1000	D1250	D1500	D2004	D500	D750	D1000	D1250	D1500	D2004
D500A	D750A	D1000A	D1250A	D1500A	D2004A	D500A	D750A	D1000A	D1250A	D1500A	D2004A
D504	D754	D1004	D1254	D1504	D2007	D504	D754	D1004	D1254	D1504	D2007
D504A	D754A	D1004A	D1254A	D1504A	D2007A	D504A	D754A	D1004A	D1254A	D1504A	D2007A
D507	D757	D1007	D1256	D1507	D2008	D507A	D757A	D1007A	D1256A	D1507A	D2008A
D507A	D757A	D1007A	D1256A	D1507A	D2008A	D508	D758	D1008	D1257	D1508	
D508	D758	D1008	D1257	D1508		D508A	D758A	D1008A	D1257A	D1508A	
D508A	D758A	D1008A	D1257A	D1508A							
			D1258								
			D1258A								
JUNCTION BOX COVER ALL MODELS 1800-2022-000											
											
SEE ACCESSORIES ON 2500 SERIES PAGE FOR T1 & T2 THERMOSTAT PARTS											

**ARWH SERIES**

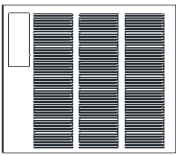
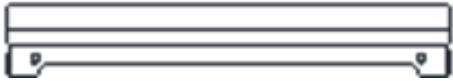

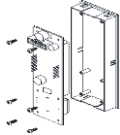
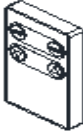
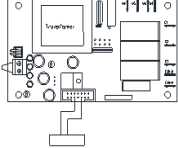
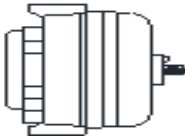

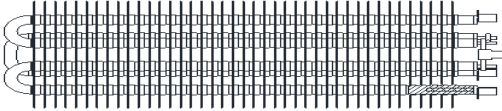
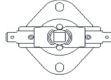
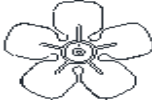
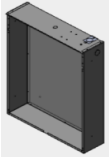

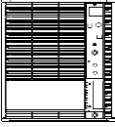

RIGHT BEZEL	LEFT BEZEL	DISPLAY ASSM.	BOTTOM BRACKET LT.	BOTTOM BRACKET RT.	REMOTE	EOL LIMIT	FAN BLADE
							
<b>1219-11009-001</b> ALL MODELS	<b>1219-11009-000</b> ALL MODELS	<b>1016-11188-000</b> ALL MODELS	<b>1215-11070-000</b> ALL MODELS	<b>1215-11070-001</b> ALL MODELS	<b>1414-11037-001</b> ALL MODELS	<b>1414-11046-000</b> ALL MODELS	<b>490030103</b> ALL MODELS
PWR CONTROL BOARD			DISCONNECT SWITCH	ELEMENT			
							
<b>1414-11033-002</b> ARWH1802 ARWH1802AL ARWH1802BZ ARWH1802W	<b>1414-11033-001</b> ARWH4807 ARWH4807AL ARWH4807BZ ARWH4807W	<b>1414-11033-000</b> ARWH4808 ARWH4804 ARWH4808AL ARWH4804AL ARWH4808BZ ARWH4804BZ ARWH4808W ARWH4804W	<b>410170001</b> ARWH1802 ARWH1802AL ARWH1802BZ ARWH1802W ARWH4804 ARWH4804AL ARWH4804BZ ARWH4804W ARWH4807 ARWH4807AL ARWH4807BZ ARWH4807W	<b>302012828</b> ARWH1802 ARWH1802AL ARWH1802BZ ARWH1802W	<b>1802-2075-801</b> ARWH4808 ARWH4808AL ARWH4808BZ ARWH4808W	<b>302012810</b> ARWH4804 ARWH4804AL ARWH4804BZ ARWH4804W	<b>302012811</b> ARWH4807 ARWH4807AL ARWH4807BZ ARWH4807W
MOTOR			BACK BOX	PARTS KIT			
							
<b>3900-11026-002</b> ARWH1802 ARWH1802AL ARWH1802BZ ARWH1802W	<b>3900-11026-001</b> ARWH4807 ARWH4807AL ARWH4807BZ ARWH4807W	<b>3900-11026-000</b> ARWH4808 ARWH4804 ARWH4808AL ARWH4804AL ARWH4808BZ ARWH4804BZ ARWH4808W ARWH4804W	<b>1203-11011-000</b> ALL MODELS	<b>1205-11023-000</b> ALL MODELS			

**SSHO SERIES**

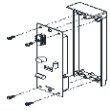
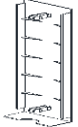

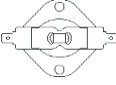
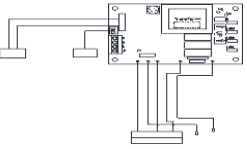
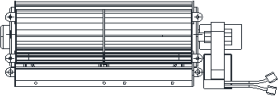



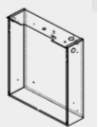







GRILLE			GRILLE TABS (2 REQ)			LIGHT
						
<b>2501-11022-000</b> HOSS4004 HOSS4007 HOSS4008	<b>2501-11022-001</b> HOSS4004SB HOSS4007SB HOSS4008SB	<b>2501-11022-002</b> HOSS4004NV HOSS4007NV HOSS408NV	<b>1402-2120-002</b> HOSS4004 HOSS4007 HOSS4008	<b>1402-2120-001</b> HOSS4004SB HOSS4007SB HOSS4008SB	<b>1402-2120-000</b> HOSS4004NV HOSS4007NV HOSS408NV	<b>3510-2017-005</b> ALL MODELS
DISPLAY ASSM.	REMOTE	CTRL PWR BOARD		MOTOR		DISCONNECT SWITCH
						
<b>1016-11199-000</b> ALL MODELS	<b>1414-11037-001</b> ALL MODELS	<b>1414-11043-000</b> HOSS4004 HOSS4004NV HOSS4004SB HOSS4008 HOSS408NV HOSS4008SB	<b>1414-11043-001</b> HOSS4007 HOSS4007NV HOSS4007SB	<b>3900-2002-522</b> HOSS4004 HOSS4004NV HOSS4004SB HOSS4008 HOSS408NV HOSS4008SB	<b>3900-2002-523</b> HOSS4007 HOSS4007NV HOSS4007SB	<b>410170001</b> ALL MODELS
ELEMENT			MANUAL LIMIT	FAN BLADE	BACK BOX	PARTS KIT
						
<b>1802-11005-000</b> HOSS4008 HOSS408NV HOSS4008SB	<b>1802-11005-001</b> HOSS4004 HOSS4004NV HOSS4004SB	<b>1802-11005-002</b> HOSS4007 HOSS4007NV HOSS4007SB	<b>4520-2027-000</b> ALL MODELS	<b>490030103</b> ALL MODELS	<b>1016-11242-000</b> ALL MODELS	<b>1205-2020-002</b> ALL MODELS





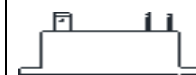





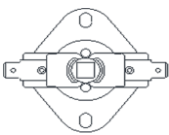

**HT SMART SERIES**

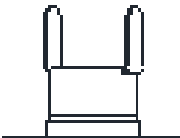
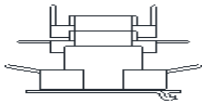
GRILLE PANEL		GRILLE ASSY INSERT		DISPLAY BEZEL	BOTTOM BEZEL	REMOTE	MANUAL LIMIT
							
2501-11003-003 HT1502SS HT2024SS	2501-11003-004 HT1502SSNW HT2024SSNW	1016-11063-000 HT1502SS HT2024SS	1016-11063-001 HT1502SSNW HT2024SSNW	1016-11035-003 HT1502SS HT2024SS HT1502SSNW HT2024SSNW	1219-11004-000 ALL MODELS	1414-11017-001 ALL MODELS	4520-11005-000 ALL MODELS
CNTRL PWR BOARD		BLOWER MOTOR		ELEMENT		LIGHT	
							
1414-11007-002 HT1502SS HT1502SSNW	1414-11007-003 HT2024SS HT2024SSNW	1225-11001-000 HT1502SS HT1502SSNW	1225-11001-001 HT2024SS HT2024SSNW	302023802 HT1502SS HT1502SSNW	302023805 HT2024SS HT2024SSNW	3510-2010-000 HT1502SS HT1502SSNW	3510-2010-001 HT2024SS HT2024SSNW
BACK BOX	PARTS KIT						
							
1016-11032-000 ALL MODELS	1205-11010-000 ALL MODELS						





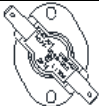

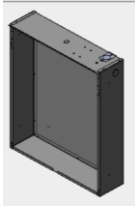



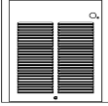

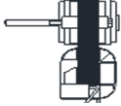

WH-FC SERIES (FRC)											
GRILLE			ELEMENTS				DISCONNECT SWITCH				
											
<b>1016-11225-000</b> WH3150FC WH44083FC WH3180FC WH4503FC WH4303FC WH4504FC WH4306FC WH45043FC WH4307FC WH4506FC WH4404FC WH4507FC WH44043FC WH4508FC WH4407FC WH45083FC WH4408FC		<b>1016-11225-001</b> WH3150FCNW WH44083FCNW WH3180FCNW WH4503FCNW WH4303FCNW WH4504FCNW WH4306FCNW WH45043FCNW WH4307FCNW WH4506FCNW WH4404FCNW WH4507FCNW WH44043FCNW WH4508FCNW WH4407FCNW WH45083FCNW WH4408FCNW		<b>302012806</b> WH4307FC WH4307FCNW <b>302012824</b> WH4506FC WH4506FCNW <b>302012808</b> WH4404FC WH4404FCNW <b>302012827</b> WH3150FC WH3150FCNW	<b>302012809</b> WH4407FC WH4407FCNW <b>302012829</b> WH3180FCNW <b>302012807</b> WH4408FC WH4408FCNW <b>302012820</b> WH4306FC WH4306FCNW	<b>302012810</b> WH4504FC WH4504FCNW <b>302012811</b> WH4507FC WH4507FCNW <b>302012819</b> WH4303FC WH4303FCNW <b>302012823</b> WH4503FC WH4503FCNW	<b>1802-2075-802</b> WH44043FC WH44043FCNW WH44083FC WH44083FCNW <b>1802-2075-803</b> WH45043FC WH45043FCNW <b>1802-2075-801</b> WH4508FC WH4508FCNW WH45083FC WH45083FCNW	<b>410170001</b> WH3150FC WH4407FC WH3150FCNW WH4407FCNW WH3180FC WH4408FC WH3180FCNW WH4408FCNW WH4307FC WH4504FC WH4307FCNW WH4504FCNW WH4404FC WH4507FC WH4404FCNW WH4507FCNW		<b>5216-2019-000</b> WH4303FC WH4503FCNW WH4303FCNW WH45043FC WH306FC WH45043FCNW WH4306FCNW WH4506FC WH44043FC WH4506FCNW WH44043FCNW WH4508FC WH44083FC WH4508FCNW WH4503FC WH45083FCNW	
MOTOR			FAN DELAY				RELAY			TRANSFORMER	
											
<b>3900-2010-000</b> WH4303FC WH4408FCNW WH4303FCNW WH4503FC WH4306FC WH4503FCNW WH4306FCNW WH4504FC WH4404FC WH4504FCNW WH4404FCNW WH4506FC WH4408FC WH4506FCNW		<b>3900-2010-001</b> WH4507NW WH4307FC WH4407FC WH4407FCNW WH4507FC WH4507FCNW	<b>3900-2010-003</b> WH3150FC WH3150FCNW WH3180FC WH3180FCNW	<b>3900-2002-518</b> WH44043FC WH44043FCNW WH44083FC WH44083FCNW WH45043FC WH45043FCNW WH4508FC WH4508FCNW WH45083FC WH45083FCNW	<b>410074000</b> WH3150FC WH4407FC WH3150FCNW WH4407FCNW WH3180FC WH4408FC WH3180FCNW WH4408FCNW WH4303FC WH4503FC WH4303FCNW WH4503FCNW WH4306FC WH4504FC WH4306FCNW WH4504FCNW WH4307FC WH4506FC WH4307FCNW WH4506FCNW WH4404FC WH4507FC WH4404FCNW WH4507FCNW	<b>4520-2024-000</b> WH44043FC WH44043FCNW WH44083FC WH44083FCNW WH45043FC WH45043FCNW WH45043FC WH45043FCNW WH4508FC WH4508FCNW WH45083FC WH45083FCNW	<b>410101002</b> WH44043FC WH44083FC WH44043FCNW WH44083FCNW WH45043FC WH4508FC WH45043FCNW WH4508FCNW WH45083FC WH45083FCNW		<b>490015017</b> WH4303FC WH4303FCNW WH4503FC WH4503FCNW	<b>490015013</b> WH4306FC WH4306FCNW WH4506FC WH4506FCNW	
THERMOSTAT	MANUAL LIMIT	FAN BLADE	RELAY FOR MODELS OLDER THAN MARCH 2020				AUTO LIMIT	BACK BOX			
											
<b>410168002</b> 1 PHASE MODELS	<b>4520-2027-000</b> ALL MODELS	<b>490030103</b> ALL MODELS	<b>5018-2017-000</b> WH44043FC WH44043FCNW WH45043FC WH45043FCNW				<b>5018-2017-004</b> WH44083FC WH44083FCNW WH4508FC WH4508FCNW WH45083FC WH45083FCNW	<b>4520-2048-000</b> WH44043FC WH44043FCNW WH44083FC WH44083FCNW WH45043FC WH45043FCNW WH4508FC WH4508FCNW	<b>1016-11243-500</b> ALL MODELS		
<b>THERMOSTAT</b> <b>5813-2027-001</b> 3 PHASE MODELS											





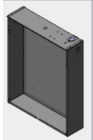







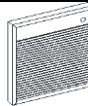

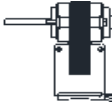
**WHB (FRA-F)**





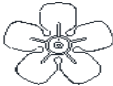













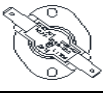

WHB (FRA-F)					
GRILLE	MANUAL LIMIT	FAN BLADE	THERMOSTAT	FAN DELAY	RELAY
					
<b>1016-11226-000</b> WHB3150FC WHB3180C WHB3307FC WHB3404FC WHB34043FC WHB3407FC WHB3408FC WHB34083FC WHB3504FC WHB35043FC WHB3507FC WHB3508FC WHB35083FC	<b>4520-2027-000</b> WHB3150FC WHB3180C WHB3307FC WHB3404FC WHB34043FC WHB3407FC WHB3408FC WHB34083FC WHB3504FC WHB35043FC WHB3507FC WHB3508FC WHB35083FC	<b>490030103</b> WHB3150FC WHB3180C WHB3307FC WHB3404FC WHB34043FC WHB3407FC WHB3408FC WHB34083FC WHB3504FC WHB35043FC WHB3507FC WHB3508FC WHB35083FC	<b>5813-2059-000</b> WHB3150FC WHB3180C WHB3307FC WHB3404FC WHB34043FC WHB3407FC WHB3408FC WHB34083FC WHB3504FC WHB35043FC WHB3507FC WHB3508FC WHB35083FC	<b>410074000</b> WHB3150FC WHB3180C WHB3307FC WHB3404FC WHB34043FC WHB3407FC WHB3408FC WHB34083FC WHB3504FC WHB35043FC WHB3507FC WHB3508FC WHB35083FC	<b>410101002</b> WHB34043FC WHB35043FC WHB34083FC WHB3508FC WHB35083FC
DISCONNECT SWITCH		ELEMENT		MOTOR	
					
<b>410170001</b> WHB3150FC WHB3180C WHB3307FC WHB3404FC WHB3407FC WHB3408FC WHB3504FC WHB3507FC	<b>5216-2019-000</b> WHB34043FC WHB34083FC WHB35043FC WHB3508FC WHB35083FC	<b>302012827</b> WHB3150FC <b>302012807</b> WHB3408FC <b>302012828</b> WHB3180C <b>302012806</b> WHB3307FC <b>302012808</b> WHB3404FC <b>302012809</b> WHB3407FC <b>302012810</b> WHB3504FC	<b>302012811</b> WHB3507FC <b>1802-2075-800</b> WHB34083FC <b>1802-2075-801</b> WHB3508FC WHB35083FC <b>1802-2075-802</b> WHB34043FC <b>1802-2075-803</b> WHB35043FC	<b>3900-2010-003</b> WHB3150FC WHB3180C <b>3900-2010-001</b> WHB3307FC WHB3507FC WHB3407FC <b>3900-2010-000</b> WHB3404FC WHB3408FC WHB3504FC	<b>3900-2002-518</b> WHB34043FC WHB34083FC WHB35043FC WHB3508FC WHB35083FC 
AUTO LIMIT	RELAY MODELS BEFORE 2020		BACK BOX		
					
<b>4520-2048-000</b> WHB34043FC WHB35043FC WHB34083FC WHB3508FC WHB35083FC	<b>5018-2017-000</b> WHB34043FC WHB35043FC	<b>5018-2017-004</b> WHB34083FC WHB3508FC WHB35083FC	<b>1016-11243-500</b> ALL MODELS		
PARTS KIT P/N 1205-11031-001 (KNOB, GRILLE SCREWS, AND PLUG BUTTONS)					





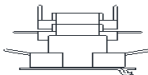





**WHB SERIES (SRA)**

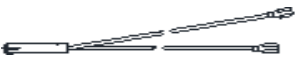

GRILLE		KNOB		ELEMENT		MOTOR	
							
<b>1016-11228-000</b> WHB1101FC WHB1151FC WHB1157FC WHB1201FC WHB1202FC WHB1207FC WHB1208FC		<b>3301-11015-001</b> WHB1101FC WHB1151FC WHB1157FC WHB1201FC WHB1202FC WHB1207FC WHB1208FC		<b>302023801</b> WHB1101FC	<b>302023805</b> WHB1202FC	<b>490062001</b> WHB1101FC WHB1151FC WHB1201FC	<b>490062004</b> WHB1157FC WHB1207FC
				<b>302023802</b> WHB1151FC	<b>302023806</b> WHB1207FC	<b>490062003</b> WHB1208FC WHB1202FC	
				<b>302023803</b> WHB1157FC	<b>302023808</b> WHB1201FC		
				<b>302023804</b> WHB1208FC			
LIGHT		THERMAL FUSE		MANUAL LIMIT		THERMOSTAT	
							
<b>3510-2017-007</b> WHB1101FC WHB1151FC WHB1201FC		<b>3510-2017-006</b> WHB1157FC WHB1202FC WHB1207FC WHB1208FC		<b>4520-2030-000</b> WHB1101FC WHB1151FC WHB1157FC WHB1201FC WHB1202FC WHB1207FC WHB1208FC		<b>5813-2001-000</b> WHB1101FC WHB1151FC WHB1157FC WHB1202FC WHB1207FC WHB1208FC	
				<b>4520-11016-000</b> WHB1101FC WHB1151FC WHB1157FC WHB1201FC WHB1202FC WHB1207FC WHB1208FC		<b>5813-2022-000</b> WHB1201FC	
DISCONNECT SWITCH		FAN BLADE		FAN DELAY		BACK BOX	
							
<b>410170001</b> ALL MODELS		<b>490061001</b> ALL MODELS		<b>410074000</b> ALL MODELS		<b>1217-2027-507</b> ALL MODELS	
<b>PARTS KIT</b> <b>1205-11032-000</b> ALL MODELS							

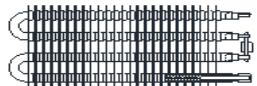
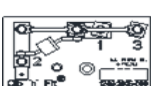
**SRA ARCHITECTURAL SERIES (SWH)**

KNOB		GRILLE		ELEMENT		
						
<b>3301-11015-003</b> SWH1012FC SWH1512FC SWH1527FC SWH1812FC SWH2020FC SWH2024FC SWH2027FC	<b>3301-2052-002</b> SWH1012AG SWH1512AG SWH1527AG SWH1812AG SWH2020AG SWH2024AG SWH2027AG SWH1012AGA SWH1512AGA SWH1527AGA SWH1812AGA SWH2020AGA SWH2024AGA SWH2027AGA	<b>1016-11227-000</b> SWH1012FC SWH1512FC SWH1527FC SWH1812FC SWH2020FC SWH2024FC SWH2027FC	<b>2501-2075-000</b> SWH1012AG SWH1512AG SWH1527AG SWH1812AG SWH2020AG SWH2024AG SWH2027AG SWH1012AGA SWH1512AGA SWH1527AGA SWH1812AGA SWH2020AGA SWH2024AGA SWH2027AGA	<b>302023801</b> SWH1012AG SWH1012AGA SWH1012FC <b>302023804</b> SWH2020AG SWH2020AGA SWH2020FC <b>302023808</b> SWH1812AG SWH1812AGA SWH1812FC	<b>302023802</b> SWH1512AG SWH1512AGA SWH1512FC <b>302023805</b> SWH2024AG SWH2024AGA SWH2024FC	<b>302023803</b> SWH1527AG SWH1527AGA SWH1527FC <b>302023806</b> SWH2027AG SWH2027AGA SWH2027FC
LIGHT				MOTOR		DISCONNECT SWITCH
						
<b>3510-2008-002</b> SWH1527AG	<b>3510-2008-003</b> SWH1012AG SWH1512AG SWH1812AG SWH2020AG SWH2024AG SWH2027AG	<b>3510-2017-007</b> SWH1012AGA SWH1512AGA SWH1812AGA SWH1012FC SWH1512FC SWH1812FC	<b>3510-2017-006</b> SWH1527AGA SWH2020AGA SWH2024AGA SWH2027AGA SWH1527FC SWH2020FC SWH2024FC SWH2027FC	<b>490062001</b> SWH1012AG SWH1512AG SWH1812AG SWH1012AGA SWH1512AGA SWH1812AGA SWH1012FC SWH1512FC SWH1812FC <b>490062002</b> SWH2020AG SWH2020AGA SWH2020FC	<b>490062003</b> SWH2024AG SWH2024AGA SWH2024FC <b>490062004</b> SWH1527AG SWH2027AG SWH1527AGA SWH2027AGA SWH1527FC SWH2027FC	<b>410170001</b> ALL MODELS <b>BACK BOX</b>  <b>1217-2027-507</b> ALL MODELS <b>PARTS KIT</b> <b>1205-11032-001</b> ALL MODELS
FAN DELAY	HI LIMIT	MANUAL LIMIT	FAN BLADE	THERMAL FUSE	THERMOSTAT	
						
<b>410074000</b> ALL MODELS	<b>410143000</b> SWH1012AG SWH1512AG SWH1527AG SWH1812AG SWH2020AG SWH2024AG SWH2027AG	<b>4520-11016-000</b> SWH1012AGA SWH1512AGA SWH1527AGA SWH1812AGA SWH2020AGA SWH2024AGA SWH2027AGA SWH1012FC SWH1512FC SWH1527FC SWH1812FC SWH2020FC SWH2024FC SWH2027FC	<b>490061001</b> ALL MODELS	<b>4520-2030-000</b> SWH1012AGA SWH1512AGA SWH1527AGA SWH1812AGA SWH2020AGA SWH2024AGA SWH2027AGA SWH1012FC SWH1512FC SWH1527FC SWH1812FC SWH2020FC SWH2024FC SWH2027FC	<b>5813-2022-000</b> SWH1812AG SWH1812AGA SWH1812FC	<b>5813-2001-000</b> SWH1012AG SWH1512AG SWH1527AG SWH2020AG SWH2024AG SWH2027AG SWH1012AGA SWH1512AGA SWH1527AGA SWH2020AGA SWH2024AGA SWH2027AGA SWH1012FC SWH1512FC SWH1527FC SWH2020FC SWH2024FC SWH2027FC
						



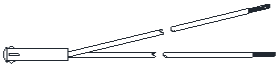
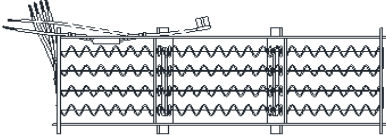
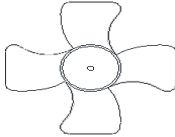
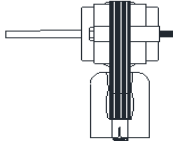
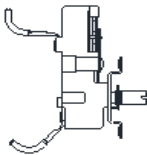
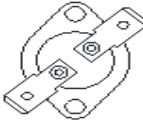
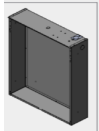

VFK-SERIES												
GRILLE			KNOB		FAN DELAY		MANUAL LIMIT					
												
<b>1402-2239-000</b> K151 K157A K204A K207A K208A K303A K304A K306A K307A K403A K404A K404A K4043A K406A K407A K408A K4083A K483A K484A K4843A K486A K487A K488A K4883A	<b>1402-2152-000</b> K204 K207 K208 K303 K304 K306 K307 K403 K404 K4043 K406 K408 K4083 K483 K484 K486 K487 K488 K4883	<b>2501-11028-000</b> K151FC K204FC K303FC K304FC K306FC K403FC K404FC K406FC K408FC K4083FC K483FC K484FC K486FC K487FC K488FC K4883FC	<b>3301-2030-001</b> K151 K204 K207A K208 K208A K303 K304 K306 K307 K403 K404 K4043 K406 K407A K408 K4083 K483 K484 K484A K486 K487 K488 K4883 K157A		<b>3301-11014-001</b> K151FC K204FC K207A K208A K303A K304A K306A K307A K403A K404A K4043A K406A K407A K408A K4083A K483A K484A K484A K486A K487A K488A K4883A		<b>4520-2024-000</b> K4043 K4043A K4083 K4083A K4083FC K4843 K4843A K488 K4883 K4883A K4883FC K4883FC		<b>410074000</b> K204 K204A K204FC K208 K208A K303 K303A K303FC K304 K304A K304FC K306 K306A K306FC K403 K403A K403FC K404 K404A K404FC K406 K406A K406FC K407A		<b>410074000</b> K406FC K408 K408A K408FC K483 K483A K483FC K484 K484A K484A K484FC K486 K486A K486FC K207 K207A K307 K307A K307A K487 K487A K487A K487FC K157A K157A K407A	<b>4520-2027-000</b> ALL MODELS  <b>AUTO LIMIT</b>  K4043 K4043A K4843 K4843A K4083 K4083A K4083FC K488 K4883 K488A K4883A K488FC K4883FC
<b>ELEMENTS</b> 				<b>MOTOR</b> 				<b>FAN BLADE</b> 				
<b>302012827</b> K151 K151FC	<b>302015802</b> K204 K204A K204FC	<b>302015803</b> K207 K207A	<b>302015801</b> K208 K208A	<b>3900-2010-003</b> K151 K151FC	<b>3900-2010-000</b> K204 K204A K204FC K208 K208A K303 K303A K303FC K304 K304A K304FC K306 K306A K306FC K403 K403A K403FC K404		<b>3900-2010-001</b> K207 K207A K307 K307A K487 K487A K487FC K157A K407A	<b>3900-2002-518</b> K4043 K4043A K4083 K4083A K4083FC K4843 K4843A K488 K4883 K488A K4883A K488FC K4883FC	<b>490030103</b> ALL MODELS <b>BACK BOX</b>  <b>1016-11243-500</b> ALL MODELS <b>PARTS KIT</b>  <b>1205-11031-002</b> ALL MODELS			
<b>302012819</b> K303 K303A K303FC	<b>302012820</b> K304 K306 K306A K306FC	<b>302012809</b> K304 K304A K304A K407A	<b>302012806</b> K307 K307A  <b>302012808</b> K404 K404A K404A K404FC  <b>302012807</b> K408 K408A K408A K408FC  <b>1802-2075-803</b> K4843 K4843A	<b>302012821</b> K403 K403A K403FC	<b>1802-2075-802</b> K4043 K4043A	<b>1802-2075-800</b> K4083 K4083A K4083A K4083FC	<b>302012822</b> K406 K406A K406FC	<b>302012823</b> K483 K483A K483A K483FC	<b>302012811</b> K487 K487A K487A K487FC	<b>1802-2075-801</b> K488 K4883 K488A K4883A K488FC K4883FC		
<b>302012824</b> K486 K486A K486FC	<b>302015806</b> K157A			<b>3900-2010-003</b> K151 K151FC	<b>3900-2010-000</b> K204 K204A K204FC K208 K208A K303 K303A K303FC K304 K304A K304FC K306 K306A K306FC K403 K403A K403FC K404		<b>3900-2010-001</b> K207 K207A K307 K307A K487 K487A K487FC K157A K407A	<b>3900-2002-518</b> K4043 K4043A K4083 K4083A K4083FC K4843 K4843A K488 K4883 K488A K4883A K488FC K4883FC	<b>490030103</b> ALL MODELS <b>BACK BOX</b>  <b>1016-11243-500</b> ALL MODELS <b>PARTS KIT</b>  <b>1205-11031-002</b> ALL MODELS			
<b>THERMOSTAT</b> 			<b>TRANSFORMER</b> 		<b>RELAY</b> 		<b>RELAY MODELS BEFORE 2020</b> 					
<b>410168002</b> K4043 K4043A K4843 K4843A	<b>5813-2027-000</b> K204 K204A K204FC K208 K208A K303 K303A K303FC K304 K304A K304A K304FC K306 K306A K306A K306FC K403 K403A K403FC K404 K404A		<b>490015017</b> K303 K403 K483 K303A K403A K483A K303FC K403FC K483FC	<b>490015013</b> K306 K406 K486 K306A K406A K486A K306FC K406FC K486FC	<b>410101002</b> K4043 K4043A K4843 K4843A  <b>VFK-F</b> 		<b>410101002</b> K4083 K4083A K4083FC K488 K4883 K488A K4883A K488FC K4883FC	<b>5018-2017-000</b> K4043 K4043A K4843 K4843A	<b>5018-2017-004</b> K4083 K4083A K4083FC K488 K4883 K488A K4883A K488FC K4883FC	<b>VFK</b> 		

GFR SERIES								
KNOB		GRILLE			LIGHT			
								
<b>3301-2014-004</b> R1500T2 R2004T2 R2404T2 R1500T2A R2004T2A R2404T2A R1500T2B R2004T2B R2404T2B	<b>3301-11015-002</b> R1500T2FC R2004T2FC R2404T2FC	<b>2501-11031-000</b> R1500FC R1500T2FC R2004FC R2004IFFC R2004T2FC R2404FC R2404IFFC R2404T2FC	<b>2501-2026-000</b> R1500 R1500T2 R2004 R2004IF R2004T2 R2404 R2404IF R2404T2 R1500A R1500T2A R2004A R2004IFA		R2004T2A R2404A R2404IFA R2404T2A R1500B R1500T2B R2004B R2004IFB R2004T2B R2404B R2404IFB R2404T2B	<b>3510-2010-000</b> R1500 R1500T2 R1500A R1500T2A R1500B R1500T2B R1500FC R1500T2FC	<b>3510-2010-001</b> R2004 R2004IF R2004T2 R2004A R2004IFA R2004T2A R2004B R2004IFB R2004T2B R2004FC R2004IFFC R2004T2FC	R2404 R2404IF R2404T2 R2404A R2404IFA R2404T2A R2404B R2404IFB R2404T2B R2404FC R2404IFFC R2404T2FC
<b>BLOWER ASM.</b> 				<b>ELEMENT</b> 			<b>CLIP N FIT BOARD</b> 	
<b>1225-2002-000</b> R1500 R1500T2 R1500A R1500T2A R1500B R1500T2B R1500FC R1500T2FC	R2404A R2404IFA R2404T2A R2404B R2404IFB R2404T2B R2404FC R2404IFFC R2404T2FC	<b>1225-2002-001</b> R2004 R2004IF R2004T2 R2404 R2404IF R2404T2 R2004A R2004IFA R2004T2A	R2004B R2004IFB R2004T2B R2004FC R2004IFFC R2004T2FC	<b>302023802</b> R1500 R1500T2 R1500A R1500T2A R1500B R1500T2B R1500FC R1500T2FC	<b>302023805</b> R2004 R2004IF R2004T2 R2004A R2004IFA R2004T2A R2004B R2004IFB R2004T2B R2004FC R2004IFFC R2004T2FC	<b>302023814</b> R2404 R2404IF R2404T2 R2404A R2404IFA R2404T2A R2404B R2404IFB R2404T2B R2404FC R2404IFFC R2404T2FC	<b>1249-2005-000</b> ALL MODELS <b>BACK BOX</b>  <b>1217-2044-000</b> ALL MODELS <b>PARTS KIT</b> <b>1205-11033-000</b> ALL MODELS	
<b>THERMOSTAT</b> 	<b>TEMPERATURE REGULATOR</b> 			<b>HI-LIMIT</b> 				
<b>410130001</b> R1500T2 R2004T2 R2404T2 R1500T2A R2004T2A R2404T2A R1500T2B R2004T2B R2404T2B R1500T2FC R2004T2FC R2404T2FC	<b>410143000</b> R1500 R1500T2 R2004 R2004IF R2004T2 R1500A R1500T2A R2004A R2004IFA R2004T2A	R1500B R1500T2B R1500FC R1500T2FC R2004B R2004IFB R2004T2B R2004FC R2004IFFC R2004T2FC	<b>4520-2029-000</b> R2404 R2404IF R2404T2 R2404A R2404IFA R2404T2A R2404B R2404IFB R2404T2B R2404FC R2404IFFC R2404T2FC	<b>4520-2025-000</b> R1500 R1500T2 R2004 R2004IF R2004T2 R1500A R1500T2A R2004A R2004IFA R2004T2A	<b>4520-2025-001</b> R2404 R2404IF R2404T2 R2404A R2404IFA R2404T2A	<b>4520-11010-000</b> R1500B R1500T2B R1500FC R1500T2FC	<b>4520-11010-001</b> R2004B R2004IFB R2004T2B R2004FC R2004IFFC R2004T2FC R2404B R2404IFB R2404T2B R2404FC R2404IFFC R2404T2FC	



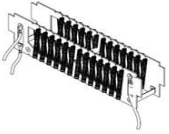
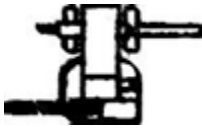

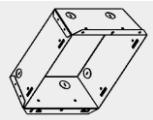

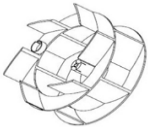



SED SERIES					
KNOB		GRILLE		LIGHT	
					
<b>3301-2044-001</b> D1012C D1024C D1012CA D1024CA	<b>3301-2039-002</b> D1012W D1512 D2024 D1012WA D1024WA D1512A D2024A	<b>2501-2054-001</b> D1012C D1024C D1512CR D1012CA D1024CA D1512CRA	<b>2501-2054-000</b> D1012W D1512 D2024 D1012WA D1024WA D1512A D2024A	<b>3510-2017-002</b> D1012C D1012W D1512 D1512CR D1012CA D1012WA D1512A D1512CRA	<b>3510-2017-003</b> D1024C D2024 D1024CA D1024WA D2024A
ELEMENT			FAN BLADE	MOTOR	
					
<b>1802-2124-003</b> D1012C D1012W D1012CA D1012WA	<b>1802-2124-005</b> D1024C D2024 D1024CA D1024WA D2024A	<b>1802-2124-000</b> D1512 D1512CR D1512A D1512CRA	<b>1210-2008-000</b> ALL MODELS	<b>3900-2037-000</b> D1012C D1012W D1512 D1512CR D1012CA D1012WA D1512A D1512CRA	<b>3900-2037-001</b> D1024C D2024 D1024CA D1024WA D2024A
THERMOSTAT		LIMIT			BACK BOX
					
<b>410130001</b> D1012C D1012W D1512 D1012CA D1012WA D1512A D1024C D2024		<b>4520-11009-000</b> D1012C D1012W D1512 D1512CR D1024C D2024		<b>4520-11009-001</b> D1012CA D1012WA D1512A D1512CRA D1024CA D1024WA D2024A	<b>1217-2062-000</b> ALL MODELS <b>PARTS KIT</b> <b>1205-2049-501</b> ALL MODELS





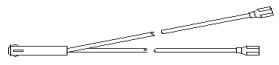
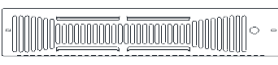
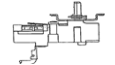





## COZ-E WALL HEATER

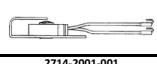
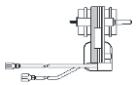
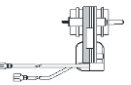









ELEMENT (INCLUDES LIMIT & ONE SHOT FUSE)		MOTOR		GRILLE
				
<b>1802-11014-011</b> CZ1012TB	<b>1802-11014-010</b> CZ1512TB	<b>3900-11032-000</b> CZ1012IF CZ1012T CZ1512IF CZ1512T	<b>3900-11032-001</b> CZ1048IF CZ1048T CZ1548IF CZ1548T CZ2048IF CZ2048T	<b>2501-11024-000</b> ALL MODELS
				<b>BACK BOX</b>
				
				<b>1217-11030-000</b> ALL MODELS
THERMOSTAT	FAN IMPELLER	PARTS KIT		
		PICTURE NOT AVAILABLE		
<b>5813-2090-000</b> CZ1012T CZ1048T CZ1512T CZ1548T CZ2048T	<b>2002-11004-000</b> ALL MODELS	<b>1205-11028-500</b> CZ1012T CZ1048T CZ1512T CZ1548T CZ2048T		

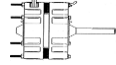





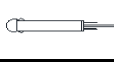















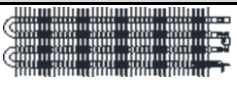
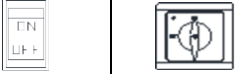

QTS SERIES							
ELEMENTS		MOTOR ASSEMBLY		HI-LIMIT	SELF HOLD LIMIT	FAN DELAY	
							
<b>302023811</b> S1100 S1100A S1100B S1100C S1100CNW	<b>302023803</b> S1104 S1104A S1104B S1104C S1104CNW	<b>1225-2002-000</b> S1100 S1100A S1100B S1100C S1100CNW	<b>1225-2002-001</b> S1104 S1104A S1104B S1104C S1104CNW	<b>4520-2031-000</b> S1100 S1100A S1100B S1104 S1104A S1104B S1500 S1500A S1500B S1500C S1500T S1500TA S1500TB S1500TC S1500TCNW	<b>4520-11011-000</b> S1100C S1100CNW S1500C S1500TC S1500TCNW	<b>1414-2020-000</b> S1100 S1100A S1104 S1104A S1500 S1500A S1500T S1500TA S1504 S1504A S1504TA	<b>410074000</b> S1100B S1100C S1100CNW S1104B S1104C S1104CNW S1500B S1500C S1500TB S1500TC S1500TCNW S1504B S1504C S1504TB S1504TCNW
<b>302023802</b> S1500 S1500A S1500B S1500C S1500T S1500TA S1500TB S1500TC S1500TCNW		<b>302023806</b> S1504 S1504A S1504B S1504C S1504T S1504TA S1504TB S1504TC S1504TCNW		S1500 S1500A S1500B S1500C S1500T S1500TA S1500TB S1500TC S1500TCNW	S1504 S1504A S1504B S1504C S1504T S1504TA S1504TB S1504TC S1504TCNW	<b>4520-11011-001</b> S1104C S1104CNW S1504C S1504TC S1504TCNW	S1500A S1500T S1500TA S1504 S1504A S1504TA
PILOT LIGHT		GRILLE			THERMOSTAT	KNOB	THERMAL CUTOFF
							
<b>3510-2010-000</b> S1100A S1100B S1100C S1100CNW S1500A S1500B S1500C S1500TA S1500TB S1500TC S1500TCNW	<b>3510-2010-001</b> S1104 S1104A S1104B S1104C S1104CNW S1504 S1504A S1504B S1504C S1504T S1504TA S1504TB S1504TC S1504TCNW	<b>2501-2039-000</b> S1100 S1100A S1100B S1100C S1104 S1104A S1104B S1104C S1500 S1500A S1500B S1500C S1500TA S1500TB		<b>2501-2039-001</b> S1500TC S1504 S1504A S1504B S1504C S1504T S1504TA S1504TB S1504TC	<b>410129001</b> S1500T S1500TA S1500TB S1500TC S1500TCNW S1504T S1504TA S1504TB S1504TC S1504TCNW	<b>3301-2020-006</b> S1500T S1500TA S1500TB S1500TC S1500TCNW S1504T S1504TA S1504TB S1504TC S1504TCNW	<b>4520-2030-000</b> ALL MODELS 

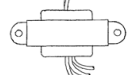





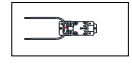



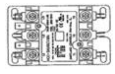

FDI SERIES				
BLADE	ELEMENT		GRILLE	BUZZER
				
<b>1210-0046-000</b> I1500 I1504	<b>1802-5032-000</b> I1500	<b>1802-5032-004</b> I1504	<b>2501-5016-001</b> I1500 I1504	<b>2714-2001-001</b> I1500 I1504
MOTOR		ONE SHOT FUSE BLUE DOT	HI LIMIT WHITE DOT	
				
<b>3900-2025-000</b> I1500	<b>3900-2025-001</b> I1504	<b>4520-2041-000</b> I1500 I1504	<b>4520-5015-001</b> I1500 I1504	

HT SERIES PUMP HOUSE HEATER		
ELEMENT	KNOB	THERMOSTAT
		
<b>1802-2091-000</b>	<b>3301-2020-006</b>	<b>5813-2062-000</b>
		
* Neutral grey finish.		

CFWF (OBSOLETE)					
TOP FRONT PANEL	BOTTOM FRONT PANEL	TOP TRIM PANEL	MOTOR	RELAY	TRANSFORMER
					
<b>1402-2312-000</b> CFWF920 CFWF920A	<b>1402-2313-000</b> CFWF920 CFWF920A	<b>5806-2004-000</b> CFWF920 CFWF920A	<b>3900-2036-000</b> CFWF920 CFWF920A	<b>5018-2017-001</b> CFWF920 CFWF920A	<b>5814-0003-000</b> CFWF920 CFWF920A
HI-LIMIT	MANUAL RESET LIMIT	ELEMENT	FAN BLADE	PILOT LIGHT	CERAMIC LIMITS
					
<b>4520-2053-000</b> CFWF920	<b>4520-2027-000</b> CFWF920A	<b>1802-2117-101</b> CFWF920 CFWF920A	<b>1210-2009-001</b> CFWF920 CFWF920A	<b>3510-2018-000</b> CFWF920 CFWF920A	<b>4520-2052-000</b> CFWF920 CFWF920A
					

QCH (U SERIES)						
GRILLE		PLASTIC COVER (2 REQ)	ELEMENTS		MOTOR	
						
1402-2121-000 U1000 U1000A U1500 U1500A U1507 U1800 U2004 U2004A U2007 U2007A U2008	1016-11228-002 U1000FA U1500FA U2004FA U2007FA	1402-2119-000 U1000 U1000A U1500 U1500A U1507 U1800 U2004 U2004A U2007 U2007A U2008	302023812 U1000 U1000A U1000FA	302023803 U1507 <del>302023808</del> U1800	490062001 U1000 U1000A U1000FA U1500 U1500A U1500FA U1800	490062003 U2004 U2004A U2004FA
			302023802 U1500 U1500A U1500FA	302023806 U2007 U2007A U2007FA	490062004 U1500 U1500A U1800	490062004 U2007 U2007A U2007FA
			302023805 U2004 U2004A U2004FA	302023804 U2008	490062004 U1507	490062002 U2008
LIGHT		FAND DELAY	HI-LIMIT	FAND BLADE	DISCONNECT SW	SOCKET ASSEMBLY
						
3510-2008-003 U1000A U1000FA U1500A U1500FA	3510-2008-002 U2004A U2004FA U2007A U2007FA	410074000 ALL MODELS	410143000 ALL MODELS	490061001 ALL MODELS	410170001 ALL MODELS	480108903 ALL MODELS

QFF (F SERIES)						
MOTOR		ELEMENT			DISCONNECT	
						
3900-2002-520 F1500	3900-2002-500 F2004 F2008	302012827 F1500	302012821 F4003	302012811 F4807	410170001 F1500 F1507	5216-2019-000 F3003 F3006
3900-2002-501 F1507 F2007 F3007 F4007 F4807	F3003 F3006 F4003 F4004 F4006 F4008	302015806 F1507	302012808 F4004	1802-2075-802 F40043	F2004 F2007 F2008 F3007 F4004 F4007 F4008 F4804 F4807	F4003 F40043 F4006 F40083 F4803 F48043 F4806 F4808 F48083 F48483 F48483LV
3900-2002-518 F40043 F40083 F48043 F4808 F48083	F4008 F4803 F4804 F4806	302015803 F2007	302012822 F4006	1802-2075-800 F40083		
		302015801 F2008	302012809 F4007	1802-2075-803 F48043		
		302012819 F3003	302012807 F4008	1802-2075-801 F4808 F48083		
	3900-2010-000 F48483 F48483LV	302012810 F3006	302012823 F4803	1802-2075-804 F48483 F48483LV		
		302012820 F3007	302012810 F4804			
		302012806 F3007	302012824 F4806			
POWER TR.	SECONDARY TR.	RELAY MODELS BEFORE 2020	RELAY	AUTO LIMIT	HI-LIMIT	FAN DELAY
						
490015017 F3003 F4003 F4803	490065002 F48483LV UNIT MOUNTED T'STAT	5018-2017-000 F40043 F48043 F48483	410101002 F40043 F48043 F48483 F4808 F48083	4520-2048-000 F40043 F48043 F48483 F4808 F48083	410169001 ALL MODELS	410074000 ALL MODELS
490015013 F3006 F4006 F4806		5018-2017-004 F40083 F4808 F48083	410101001 F48483LV			
490015022 F48483 F48483LV	FT1 ASSEMBLY 5813-2028-000 FFT2 ASSEMBLY 5813-2029-000	5018-2017-001 F48483LV			1402-2139-001 ALL MODELS	490030103 ALL MODELS

FFCH (500 SERIES)						
ELEMENT	MOTOR	RELAY	OUTLET GRILLE (2 REQ'D)	LOUVER GUIDES NAV W.	LOUVER GUIDES NOR W.	
						
302012802 542	302012813 552	5018-11006-000 542	2501-2020-001 NAVAJO WHITE	1215-2059-000 REA (2 REQ'D)	1215-2059-002 REA (2 REQ'D)	
302012803 547	302012814 557	5018-11006-000 548	2501-2020-002 NORTHERN WHITE	1215-2059-001 SEA (2 REQ'D)	1215-2059-003 SEA (2 REQ'D)	
302012801 548	302012812 558	5018-11006-001 547	GRILLE PANEL	GRILLE PANEL	THERMOSTAT	
		3900-2011-001 547				
		3900-2011-001 557	NAVAJO SEB 2016-11147-000 NORTHERN SEBNW 4513-11057-001	NAVAJO REB 4513-11057-001 NORTHERN REBNW 4513-11057-000		
FAN DELAY	FAN BLADE	HI-LIMIT	POWER BLOCK			
						
1414-2039-000 ALL MODELS	1210-2000-000 ALL MODELS	4520-0011-000 ALL MODELS	5823-0004-000 MODELS NOT ENDING IN A		500T ALL MODELS	

\* MODELS ENDING IN (A) USE SAME PARTS BUT DO NOT HAVE POWER BLOCKS

**CUH900 SERIES**



**ELEMENTS**













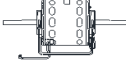









MODEL	NO. REQ.	208V	NO. REQ.	240V	NO. REQ.	277V	NO. REQ.	347V	NO. REQ.	380V	NO. REQ.	480V	NO. REQ.	600V
<b>935</b>														
2KW	1	1802-2083-100	1	1802-2083-101	1	1802-2083-114	1	1802-2083-103	1	1802-2083-101	1	1802-2083-114	1	1802-2083-103
3KW	1	1802-2083-107	1	1802-2083-108	1	1802-2083-116	1	1802-2083-105	1	1802-2083-108	1	1802-2083-116	1	1802-2083-105
4KW	1	1802-2083-106	1	1802-2083-107	1	1802-2083-108	1	1802-2083-109	1	1802-2083-107	1	1802-2083-118	1	1802-2083-109
5KW	1	1802-2083-110	1	1802-2083-111	1	1802-2083-120	1	1802-2083-113	1	1802-2083-111	1	1802-2083-120	1	1802-2083-113
6KW	2	1802-2083-107	2	1802-2083-108	2	1802-2083-116	2	1802-2083-105	2	1802-2083-108	2	1802-2083-116	2	1802-2083-105
7KW	1	1802-2083-106	1	1802-2083-107	1	1802-2083-116	1	1802-2083-109	1	1802-2083-107	1	1802-2083-116	1	1802-2083-109
	1	1802-2083-107	1	1802-2083-108	1	1802-2083-118	1	1802-2083-109	1	1802-2083-108	1	1802-2083-118	1	1802-2083-109
8KW	1	1802-2083-107	1	1802-2083-108	1	1802-2083-116	1	1802-2083-105	1	1802-2083-108	1	1802-2083-116	1	1802-2083-105
	1	1802-2083-110	1	1802-2083-111	1	1802-2083-120	1	1802-2083-113	1	1802-2083-111	1	1802-2083-120	1	1802-2083-113
<b>945</b>														
4KW	2	1802-2083-100	2	1802-2083-101	2	1802-2083-114	2	1802-2083-103	2	1802-2083-101	2	1802-2083-114	2	1802-2083-103
6KW	2	1802-2083-107	2	1802-2083-108	2	1802-2083-116	2	1802-2083-105	2	1802-2083-108	2	1802-2083-116	2	1802-2083-105
8KW	2	1802-2083-106	2	1802-2083-107	2	1802-2083-108	2	1802-2083-109	2	1802-2083-107	2	1802-2083-118	2	1802-2083-109
10KW	2	1802-2083-110	2	1802-2083-111	2	1802-2083-120	2	1802-2083-113	2	1802-2083-111	2	1802-2083-120	2	1802-2083-113
12KW	4	1802-2083-107	4	1802-2083-108	4	1802-2083-116	4	1802-2083-105	4	1802-2083-108	4	1802-2083-116	4	1802-2083-105
14KW	2	1802-2083-106	2	1802-2083-107	2	1802-2083-116	2	1802-2083-105	2	1802-2083-107	2	1802-2083-116	2	1802-2083-105
	2	1802-2083-107	2	1802-2083-108	2	1802-2083-118	2	1802-2083-109	2	1802-2083-108	2	1802-2083-118	2	1802-2083-109
16KW	2	1802-2083-107	2	1802-2083-108	2	1802-2083-116	2	1802-2083-105	2	1802-2083-108	2	1802-2083-116	2	1802-2083-105
	2	1802-2083-110	2	1802-2083-111	2	1802-2083-120	2	1802-2083-113	2	1802-2083-111	2	1802-2083-120	2	1802-2083-113
<b>58" AND LARGER HEATERS CONTACT FACTORY WITH CFID# ON UNIT'S NAMEPLATE</b>														





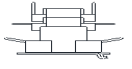
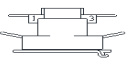
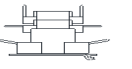
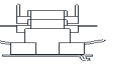
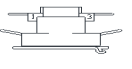
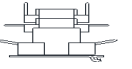
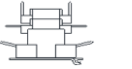
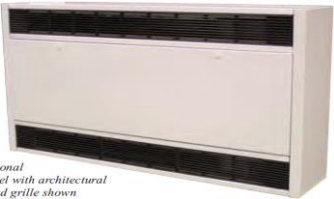

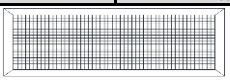
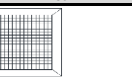

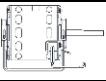
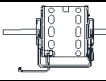
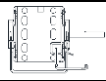
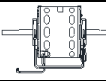
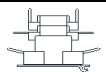
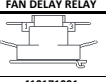
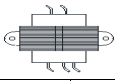
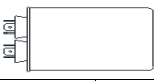
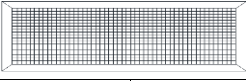
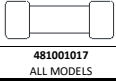

**LOUVERED PANELS**

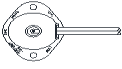
<b>DESERT TAN</b>	35"	4513-2114-T35	<b>NAVAJO WHITE</b>	35"	4513-2114-P35	<b>NORTHERN WHITE</b>	35"	4513-2114-W35	<b>STAT BRONZE</b>	35"	4513-2114-S35	
	45"	4513-2114-T45		45"	4513-2114-P45		45"	4513-2114-W45		45"	4513-2114-S45	
	58"	4513-2114-T58		58"	4513-2114-P58		58"	4513-2114-W58		58"	4513-2114-S58	
	78"	4513-2114-T78		78"	4513-2114-P78		78"	4513-2114-W78		78"	4513-2114-S78	
<b>ALUMINUM</b>	35"	4513-2114-A35	<b>BLACK</b>	35"	4513-2114-B35	<b>CHARCOL GREY</b>	35"	4513-2114-G35	<b>NEUTRAL GREY</b>	35"	4513-2114-N35	
	45"	4513-2114-A45		45"	4513-2114-B45		<b>AR. NEUTRAL GREY</b>	45"		4513-2114-NA45	45"	4513-2114-N45
	58"	4513-2114-A58		58"	4513-2114-B58					58"	4513-2114-N58	
			78"	4513-2114-B78			78"	4513-2114-N78				

**PANEL GRILLES NEW MODELS**







<b>NORTHERN WHITE</b>	35"	2501-11040-000W	<b>BEIGE</b>	35"	2501-11040-000N	<b>BLACK</b>	35"	2501-11040-000B	<b>ALUMINUM</b>	35"	2501-11040-000A
	45"	2501-11040-001W		45"	2501-11040-001N		45"	2501-11040-001B		45"	2501-11040-001A
	58"	2501-11040-003W		58"	2501-11040-003N		58"	2501-11040-003B		58"	2501-11040-003A
	78"	2501-11040-004W		78"	2501-11040-004N		78"	2501-11040-004B		78"	2501-11040-004A
<b>STAT BRONZE</b>	35"	2501-11040-000S									
	45"	2501-11040-001S									
	58"	2501-11040-003S									
	78"	2501-11040-004S									

CUH900 CONTINUED						
PRIMARY TRANSFORMER		SEC. TRANSFORMER		MOTORS		BLOWER WHEEL
						
CONTACT FACTORY WITH CFID# ON UNIT'S NAMEPLATE OR TRANSFORMER LABEL, PART NUMBERS ARE GENERALLY ON THE PARTS LABEL		490026910 MODELS WITH 24V CONTR.		2408/240V 3900-2032-000 277V 3900-2032-001 480V 3900-2032-002 SEE MOTOR LABEL SINGLE SHAFT	2408/240V 3900-2033-000 277V 3900-2033-001 480V 3900-2033-002 SEE MOTOR LABEL DOUBLE SHAFT	490047001 ALL MODELS
DAMPER MOTOR	DAMPER RHEOSTAT	DAMPER RHEOSTAT KNOB	THERMOSTAT SPST	THERMOSTAT 2STG	THERMOSTAT KNOB	PLUG BUTTON
						
3900-2023-000 MODELS WITH AIR DAMPER	410104001 MODELS WITH AIR DAMPER	482084001 MODELS WITH AIR DAMPER	410127001 SINGLE STAGE MODELS	5813-2008-000 TWO STAGE MODELS	3301-2020-001 ALL MODELS	4506-2012-000 ALL MODELS
DAMPER ROCKER SW	FAN AUTO/ON SW	ON/OFF SW	HIGH/LOW SW	DOOR SAFETY SW	AUTO HIGH LIMIT	MANUAL LIMIT
						
410131001 MODELS WITH AIR DAMPER	5216-2029-001 ALL MODELS	5216-2029-001 ALL MODELS	5216-2029-000 SINGLE STAGE MODELS	5216-2028-000 ALL MODELS	4520-2048-000 ALL MODELS	4520-2017-000 ALL MODELS
FAN AUTO RELAY (120V)	FAN DELAY RELAY(120V)	POWER RELAY (120)	FAN AUTO RELAY (24V)	FAN DELAY RELAY (24V)	POWER RELAY (24)	NIGHT SETBACK RELAY
						
410101003 MODELS WITH 120V CONTROL	410171002 MODELS WITH 120V CONTROL	410101003 MODELS WITH 120V CONTROL	410101001 MODELS WITH 24V CONTROL	410171001 MODELS WITH 24V CONTROL	410101001 MODELS WITH 24V CONTROL	410101001 MODELS WITH N.S. RELAY
FUSE	FILTER	FILTER REUSABLE	DISCONNECT SW		<b>NOTES:</b> * TAKES TWO MOTORS ** TAKES ONE OF EACH TYPE MOTOR  <i>Optional model with architectural styled grille shown</i>	
						
481001017 ALL MODELS	2010-7008-006 CU935	2010-7009-006 CU935	30 AMP	5216-2033-000		
<b>FUSE HOLDER</b> 	2010-7008-007 CU945	2010-7009-007 CU945	60 AMP	5216-2033-001		
	2010-7008-008 CU958	2010-7009-008 CU958	100 AMP	5216-2033-002		
480087001 ALL MODELS	2010-7008-009 CU968	2010-7009-009 CU968				
	2010-7008-010 CU978	2010-7009-010 CU978				

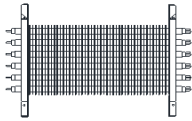
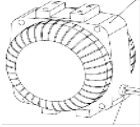
CUH 900 SERIES STOCK MODELS						
ELEMENT		MOTOR				TIME DELAY RELAY
						
1802-2083-110 S93505203FFB S94510203FFB	1802-2083-120 S93505483FFB S94510483FFB	3900-2032-000 S93505203FFB S93505243FFB S93505483FFB S93505603FFB	3900-2033-000 S94510203FFB S94510243FFB S94510483FFB S94510603FFB	3900-2032-001 S93505271FFNC	3900-2033-001 S94510271FFNC	410101001 ALL MODELS
1802-2083-111 S93505243FFB S94510243FFB	S93505271FFNC S93505483FFB S94510271FFNC	S93505483FFB S93505603FFB	S94510483FFB S94510603FFB	3900-2032-001 S93505483FFNC	3900-2033-002 S94510483FFNC	FAN DELAY RELAY 
1802-2083-121 S93505603FFB S94510603FFB	S94510483FFNC					410171001 ALL MODELS
PRI. TRANSFORMER	CAPACITOR		FILTER		FUSE	
						
490015025 S93505483FFB S94510483FFB	490015026 S93505603FFB S94510603FFB	1432-0002-003 S93505203FFB S93505243FFB S93505483FFB S93505603FFB S94510243FFB S94510483FFB S94510603FFB	1432-0002-001 S94510203FFB	2010-7008-006 S93505203FFB S93505243FFB S93505483FFB S93505603FFB	2010-7008-007 S94510203FFB S94510243FFB S94510483FFB S94510603FFB	481001017 ALL MODELS
490026002 S93505271FFNC S94510271FFNC	5814-0003-002 S93505483FFNC S94510483FFNC					FUSE HOLDER 
						480087001 ALL MODELS
SEC. TR (240/24V)	MANUAL RESET	LIMIT	HIGH/LOW SW.	DOOR SW.	FAN AUTO/ON SW.	BLOWER WHEEL
						
490026910 ALL MODELS	4520-2017-000 ALL MODELS	4520-2048-000 ALL MODELS	5216-2029-000 ALL MODELS	5216-2028-000 ALL MODELS	5216-2029-001 ALL MODELS	490047001 ALL MODELS
THERMOSTAT	T'STAT KNOB	PLUG BUTTON				
						
410127001 ALL MODELS	3301-2020-001 ALL MODELS	4506-2012-000 ALL MODELS				

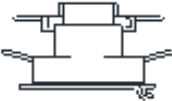



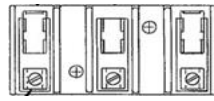
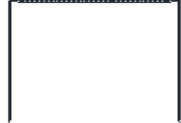

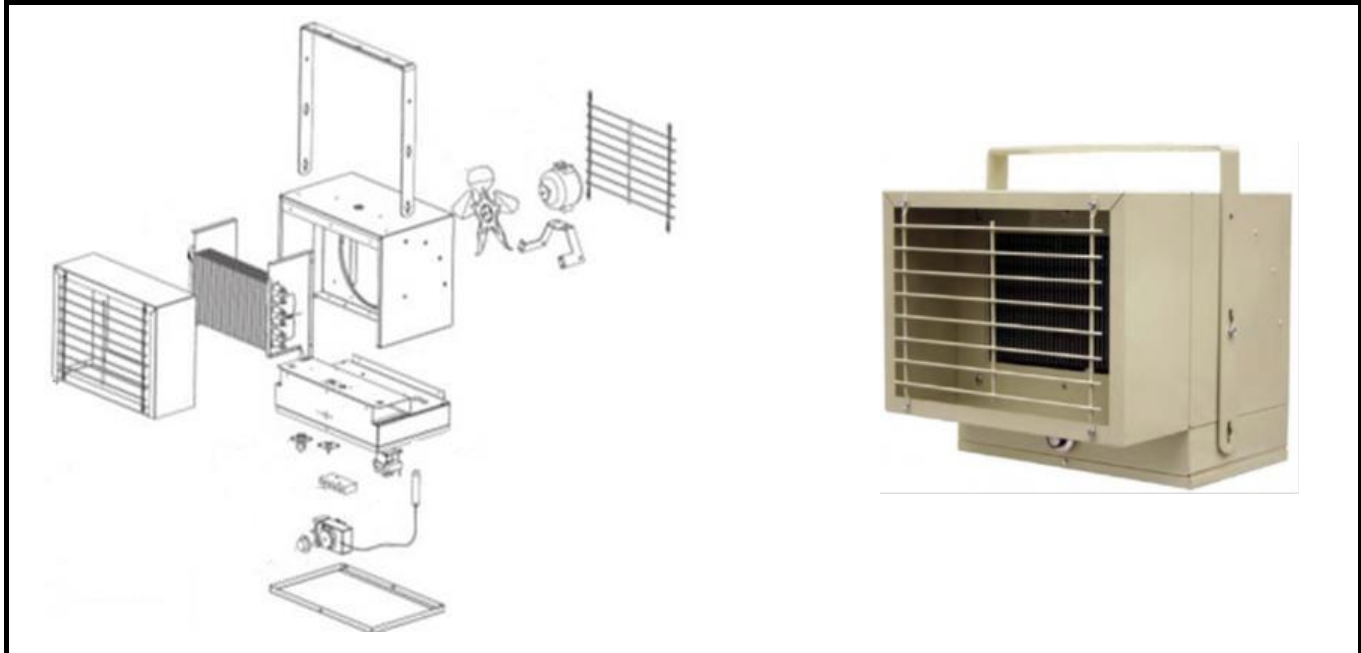





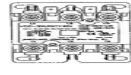



**COMPACT FREEZE PROTECTION HEATERS PHFP25**





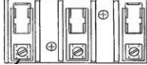





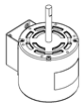
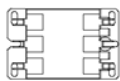
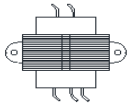

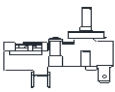
ELEMENT	MOTOR	FAN BLADE	FAN RELAY	RELAY
				
<b>1802-11002-000</b> PHFP25	<b>3900-11007-001</b> PHFP25	<b>1210-2017-000</b> PHFP25	<b>410171003</b> PHFP25	<b>1414-2038-000</b> PHFP25
THERMOSTAT	KNOB	HI LIMIT	POWER BLOCK	MT. BRACKET
				
<b>5813-2091-000</b> PHFP25	<b>3301-2053-000</b> PHFP25	<b>1414-2037-000</b> PHFP25	<b>5823-0004-005</b> PHFP25	<b>310876001</b> PHFP25

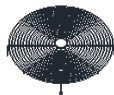
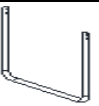
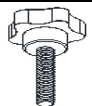

HUH SERIES

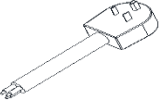
ELEMENT			FAN BLADE		MOTOR		RELAY			
										
302006804 UH520 UH520A	302006811 UH727 UH727A	302006842 UH1534 UH1560	1210-2017-000 UH520 UH520A UH524 UH524A	490011001 UH1020 UH1024 UH1027 UH1034 UH1048 UH1060 UH1520 UH1524 UH1527 UH1534 UH1548 UH1560A UH1560	3900-2008-000 UH520 UH520A UH524 UH534 UH534A UH538 UH538A UH548 UH548A UH560 UH560A	490059004 UH1020 UH1024 UH1027 UH1034 UH1048 UH1060 UH1520 UH1524 UH1527 UH1534 UH1548 UH1560 UH1560A	5018-0004-102 UH520A UH524A UH538 UH538A UH548 UH548A UH560 UH560A UH720 UH724 UH748 UH748A UH760 UH760A UH1034	5018-0003-002 UH534 UH534A UH734 UH734A UH1534	5018-0005-006 UH1020 UH1024 UH1027 UH1048 UH1060 UH1520 UH1524 UH1527 UH1548 UH1560 UH2034 UH2048 UH2060 UH2548 UH2560 UH3048 UH3060	
302006807 UH524 UH524A UH548 UH548A	302006840 UH734 UH734A UH760 UH760A	302006829 UH2548 302006843 UH2560 302006822 UH3048 302006844 UH3060	UH534 UH534A UH538 UH538A UH548 UH548A UH560 UH560A UH720 UH720A UH724 UH724A UH727 UH727A UH734 UH734A UH748 UH748A UH760 UH760A	UH1020 UH1024 UH1027 UH1034 UH1048 UH1060 UH1520 UH1524 UH1527 UH1534 UH1548 UH1560 UH1560A UH1560	UH520 UH520A UH524 UH534 UH534A UH538 UH538A UH548 UH548A UH560 UH560A UH720 UH720A UH724 UH724A UH727 UH727A UH734 UH734A UH748 UH748A UH760 UH760A	UH1020 UH1024 UH1027 UH1034 UH1048 UH1060 UH1520 UH1524 UH1527 UH1534 UH1548 UH1560 UH1560A UH720 UH724 UH748 UH748A UH760 UH760A UH2548 UH2560 UH3048 UH3060	UH520A UH524A UH538 UH538A UH548 UH548A UH560 UH560A UH720 UH724 UH748 UH748A UH760 UH760A UH1034	UH534 UH534A UH734 UH734A UH1534	UH1020 UH1024 UH1027 UH1048 UH1060 UH1520 UH1524 UH1527 UH1548 UH1560 UH2034 UH2048 UH2060 UH2548 UH2560 UH3048 UH3060	
302006839 UH534 UH534A UH560 UH560A	302006812 UH1020 UH1527 302006813 UH1024 UH1048 UH1520 UH2048	UH1020 UH1527 UH3060	UH538 UH538A UH548 UH548A UH560 UH560A UH720 UH720A UH724 UH724A UH727 UH727A UH734 UH734A UH748 UH748A UH760 UH760A	UH1020 UH1024 UH1027 UH1034 UH1048 UH1060 UH1520 UH1524 UH1527 UH1534 UH1548 UH1560 UH1560A UH720 UH724 UH748 UH748A UH760 UH760A	UH520 UH520A UH524 UH534 UH534A UH538 UH538A UH548 UH548A UH560 UH560A UH720 UH720A UH724 UH724A UH727 UH727A UH734 UH734A UH748 UH748A UH760 UH760A	UH1020 UH1024 UH1027 UH1034 UH1048 UH1060 UH1520 UH1524 UH1527 UH1534 UH1548 UH1560 UH1560A UH720 UH724 UH748 UH748A UH760 UH760A UH2548 UH2560 UH3048 UH3060	UH520A UH524A UH538 UH538A UH548 UH548A UH560 UH560A UH720 UH724 UH748 UH748A UH760 UH760A UH1034	UH534 UH534A UH734 UH734A UH1534	UH1020 UH1024 UH1027 UH1048 UH1060 UH1520 UH1524 UH1527 UH1548 UH1560 UH2034 UH2048 UH2060 UH2548 UH2560 UH3048 UH3060	
302006848 UH538 UH538A	UH1048 UH1520 UH2048	UH1020 UH1527 UH3060	UH538 UH538A UH548 UH548A UH560 UH560A UH720 UH720A UH724 UH724A UH727 UH727A UH734 UH734A UH748 UH748A UH760 UH760A	UH1020 UH1024 UH1027 UH1034 UH1048 UH1060 UH1520 UH1524 UH1527 UH1534 UH1548 UH1560 UH1560A UH720 UH724 UH748 UH748A UH760 UH760A	UH520 UH520A UH524 UH534 UH534A UH538 UH538A UH548 UH548A UH560 UH560A UH720 UH720A UH724 UH724A UH727 UH727A UH734 UH734A UH748 UH748A UH760 UH760A	UH1020 UH1024 UH1027 UH1034 UH1048 UH1060 UH1520 UH1524 UH1527 UH1534 UH1548 UH1560 UH1560A UH720 UH724 UH748 UH748A UH760 UH760A UH2548 UH2560 UH3048 UH3060	UH520A UH524A UH538 UH538A UH548 UH548A UH560 UH560A UH720 UH724 UH748 UH748A UH760 UH760A UH1034	UH534 UH534A UH734 UH734A UH1534	UH1020 UH1024 UH1027 UH1048 UH1060 UH1520 UH1524 UH1527 UH1548 UH1560 UH2034 UH2048 UH2060 UH2548 UH2560 UH3048 UH3060	
302006809 UH720 UH720A	302006814 UH1027 UH1524 UH1548	UH1020 UH1527 UH3060	UH538 UH538A UH548 UH548A UH560 UH560A UH720 UH720A UH724 UH724A UH727 UH727A UH734 UH734A UH748 UH748A UH760 UH760A	UH1020 UH1024 UH1027 UH1034 UH1048 UH1060 UH1520 UH1524 UH1527 UH1534 UH1548 UH1560 UH1560A UH720 UH724 UH748 UH748A UH760 UH760A	UH520 UH520A UH524 UH534 UH534A UH538 UH538A UH548 UH548A UH560 UH560A UH720 UH720A UH724 UH724A UH727 UH727A UH734 UH734A UH748 UH748A UH760 UH760A	UH1020 UH1024 UH1027 UH1034 UH1048 UH1060 UH1520 UH1524 UH1527 UH1534 UH1548 UH1560 UH1560A UH720 UH724 UH748 UH748A UH760 UH760A UH2548 UH2560 UH3048 UH3060	UH520A UH524A UH538 UH538A UH548 UH548A UH560 UH560A UH720 UH724 UH748 UH748A UH760 UH760A UH1034	UH534 UH534A UH734 UH734A UH1534	UH1020 UH1024 UH1027 UH1048 UH1060 UH1520 UH1524 UH1527 UH1548 UH1560 UH2034 UH2048 UH2060 UH2548 UH2560 UH3048 UH3060	
302006810 UH724 UH724A UH748 UH748A	302006841 UH1034 UH1060 UH2034 UH2060	UH1020 UH1527 UH3060	UH538 UH538A UH548 UH548A UH560 UH560A UH720 UH720A UH724 UH724A UH727 UH727A UH734 UH734A UH748 UH748A UH760 UH760A	UH1020 UH1024 UH1027 UH1034 UH1048 UH1060 UH1520 UH1524 UH1527 UH1534 UH1548 UH1560 UH1560A UH720 UH724 UH748 UH748A UH760 UH760A	UH520 UH520A UH524 UH534 UH534A UH538 UH538A UH548 UH548A UH560 UH560A UH720 UH720A UH724 UH724A UH727 UH727A UH734 UH734A UH748 UH748A UH760 UH760A	UH1020 UH1024 UH1027 UH1034 UH1048 UH1060 UH1520 UH1524 UH1527 UH1534 UH1548 UH1560 UH1560A UH720 UH724 UH748 UH748A UH760 UH760A UH2548 UH2560 UH3048 UH3060	UH520A UH524A UH538 UH538A UH548 UH548A UH560 UH560A UH720 UH724 UH748 UH748A UH760 UH760A UH1034	UH534 UH534A UH734 UH734A UH1534	UH1020 UH1024 UH1027 UH1048 UH1060 UH1520 UH1524 UH1527 UH1548 UH1560 UH2034 UH2048 UH2060 UH2548 UH2560 UH3048 UH3060	
<b>LIGHT</b>	<b>FUSE BLOCK</b>	<b>FUSE</b>	<b>CAPACITOR</b>	<b>HI LIMIT</b>	<b>FAN DELAY</b>	<b>TRANSFORMER</b>				
										
3510-2017-003 UH524A UH724A	480099002 UH1020 UH1024 UH1520 480099003 UH1520 UH1524 480096000 UH1527 480099001 UH1534 UH2034 2025-0001-000 UH2034	481001003 UH1020 UH1024 UH1520 UH1534 UH2034 481001006 UH1520 UH1524 481001023 UH1527 2019-7002-007 UH2034	1432-0002-003 UH2548 UH2560 UH3048 UH3060	410027000 ALL MODELS	410148000 ALL MODELS	490015017 UH534 UH534A UH734 UH734A 490015014 UH538 UH538A 490056001 UH548 UH548A UH748 UH748A	490015013 UH560 UH560A UH760 UH760A 490015009 UH1027 UH1527 490015019 UH1034 UH1534 UH2034	490015010 UH1048 UH1548 UH2048 490015012 UH1060 UH1560 UH2060 490015008 UH2548 UH3048 490015015 UH2560 UH3060		
<b>QUANTITY</b> 5 & 7.5KW (4) 10 THRU 20KW (6) 25 & 30KW (9)		<b>LOUVER SPRING</b>		<b>MT. BRACKET</b>		<b>THERMOSTAT (ASSEMBLY INCLUDES KNOB)</b>				
3503-2004-109 UH520 UH520A UH524 UH524A UH534 UH534A UH538 UH538A UH548 UH548A UH560 UH560A UH720 UH720A UH724 UH724A UH727 UH727A UH734 UH734A UH748 UH748A UH760 UH760A	3503-2004-111 UH1020 UH1024 UH1027 UH1034 UH1048 UH1060 UH1520 UH1524 UH1527 UH1534 UH1548 UH1560 UH1560A UH2034 UH2048 UH2060	3503-2004-112 UH2548 UH2560 UH3048 UH3060	5208-7005-001 ALL MODELS	29214-11621 UH520 UH520A UH524 UH524A UH534 UH534A UH538 UH538A UH548 UH548A UH560 UH560A UH720 UH720A UH724 UH724A UH727 UH727A UH734 UH734A UH748 UH748A UH760 UH760A	310876001 UH520 UH520A UH524 UH524A UH534 UH534A UH538 UH538A UH548 UH548A UH560 UH560A UH720 UH720A UH724 UH724A UH727 UH727A UH734 UH734A UH748 UH748A UH760 UH760A	5823-0004-000 UH520 UH520A UH524 UH524A UH534 UH534A UH538 UH538A UH548 UH548A UH560 UH560A UH720 UH720A UH724 UH724A UH727 UH727A UH734 UH734A UH748 UH748A UH760 UH760A 5823-0004-005 UH734 UH734A	480100001 UH1020 UH1024 UH1027 UH1034 UH1048 UH1060 UH1520 UH1524 UH1527 UH1534 UH1548 UH1560 UH1560A UH2034 UH2048 UH2060 480034002 UH2548 UH2560 UH3048 UH3060	410112000 THERMOSTAT 3301-2020-003 KNOB UHTA2 (ASSEMBLY 2-STAGE) 5813-2087-000 THERMOSTAT 3301-2053-000 KNOB		

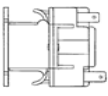
### MEDH SERIES

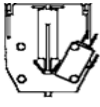
ELEMENT SMALL	ELEMENT LARGE	MOTOR	CONTACTOR	TRANSFORMER	
					
<b>1802-11001-000</b> DH1583CKD <b>1802-11001-002</b> DH1021CKD DH1021D DH1521D DH1523D DH1543CKD DH3043D	<b>1802-11001-001</b> DH1583CKD <b>1802-11001-003</b> DH1021CKD DH1021D DH1521D DH1523D DH1543CKD DH3043D	<b>3900-11002-000</b> DH1583CKD DH1021CKD DH1021D DH1521D DH1523D <b>3900-11002-001</b> DH1543CKD DH3043D	<b>5018-0006-007</b> DH1583CKD DH1521D DH1523D	<b>5018-0006-009</b> DH1543CKD DH3043D <b>5018-0006-010</b> DH1021CKD	<b>5814-0003-002</b> DH1543CKD DH3043D
FAN BLADE	HI LIMIT	THERMOSTAT	CAPACITOR	GUARDS QTY.2 NEEDED	
					
<b>1210-0098-001</b> ALL MODELS	<b>410029000</b> ALL MODELS	<b>5813-2059-000</b> ALL MODELS	<b>1432-0002-003</b> ALL MODELS	<b>2504-11005-000</b> ALL MODELS	
HANDLE	CART KNOB	THERMOSTAT KNOB	WHEEL	SHAFT CAP	AXEL SHAFT
					
<b>2710-11001-000</b> ALL MODELS	<b>3301-11003-000</b> ALL MODELS	<b>3301-11018-002</b> ALL MODELS	<b>6406-0002-000</b> ALL MODELS	<b>1408-11002-000</b> ALL MODELS	<b>5217-11001-000</b> ALL MODELS
CORD	FUSE	FUSE BLOCK	FAN RELAY	FAN DELAY	AUXILIARY SWITCH
					
<b>SCS25064</b> DH1583CKD <b>SCS10063</b> DH1021CKD <b>SCS25124</b> DH1543CKD	<b>2019-7008-077</b> DH1521D	<b>480030007</b> DH1521D	<b>5018-0007-000</b> DH1543CKD DH3043D	<b>1414-2039-000</b> DH3043D	<b>5216-10564-000</b> DH1521D

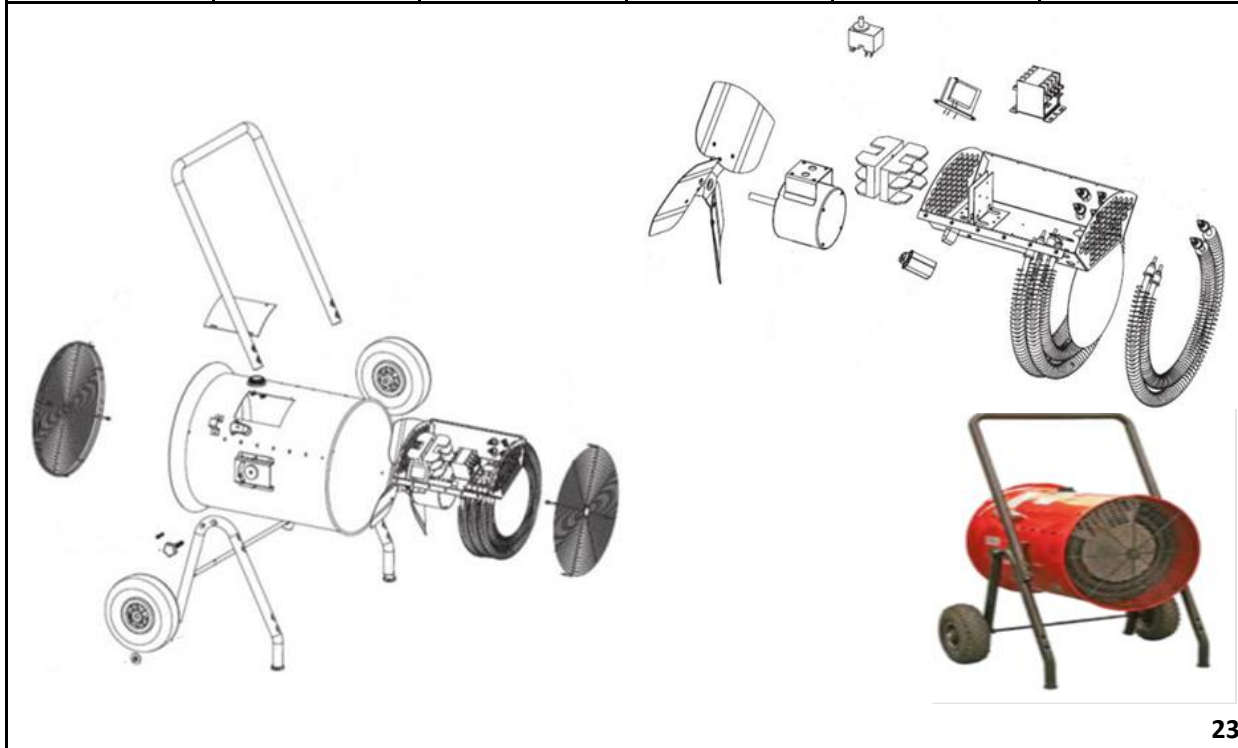



**BSDH**

MODEL	ELEMENT (11)	ELEMENT (12)	MOTOR (16)	CONTACTOR (20)
SDH3043	118-304793-011 (3)	118-304793-013 (3)	193-121843-232	072-304551-008
SDH3093	118-304793-012 (3)	118-304793-014 (3)	193-121843-233	072-304551-008
SDH4843	118-304793-011 (3)	118-304793-013 (6)	193-121843-232	072-304551-008 (2)
SDH4893	118-304793-012 (3)	118-304793-014 (6)	193-121843-233	072-304551-008 (2)
SDH6043	118-304793-011 (6)	118-304793-013 (6)	193-121843-232	072-304551-008 (2)
SDH6093	118-304793-012 (6)	118-304793-014 (6)	193-121843-233	072-304551-008 (2)
MODEL	TRANSFORMER (21)	FUSE BLOCK (80)	FUSE (81)	TERM. BLOCK (84)
SDH3043	315-304252-001	NA	NA	NA*
SDH3093	315-304252-003	NA	NA	NA*
SDH4843	315-304252-001	129-025643-001	128-026510-005 (3)	303-047468-004
SDH4893	315-304252-003	129-025643-001	128-026510-005 (3)	303-047468-004
SDH6043	315-304252-001	129-025643-001 (2)	128-026510-006 (6)	303-047468-004
SDH6093	315-304252-003	129-025643-001 (2)	128-026510-006 (6)	303-047468-004

**PARTS COMMON TO ALL UNITS**

TEMPERATURE CONTROL (18)	300-019560-002
HI-LIMIT (19)	300-049200-004
TOGGLE SWITCH (23)	292-046123-001
BLOWER ASSEMBLY (32)	021-304823-009
INLET & OUTLET GRILLE (33)	134-304780-002 (2)
CASTER/LOCKING (36)	375-122535-007
HANDLE-RIGHT SIDE (37)	139-304779-003
HANDLE-LEFT SIDE (38)	139-304479-004
SEMI-PNEUMATIC WHEEL (45)	333-557518-004 (2)
PULLEY VAR. PITCH 7/8" (77)	225-305091-004
PULLEY VAR. PITCH 5/8" (78)	225-305091-003
PULLEY BELT (79)	017-049702-009
PILOT LIGHT-GREEN (86)	213-122066-043
PILOT LIGHT-AMBER (87)	213-122066-042
THERMOSTAT KNOB (94)	169-017949-004

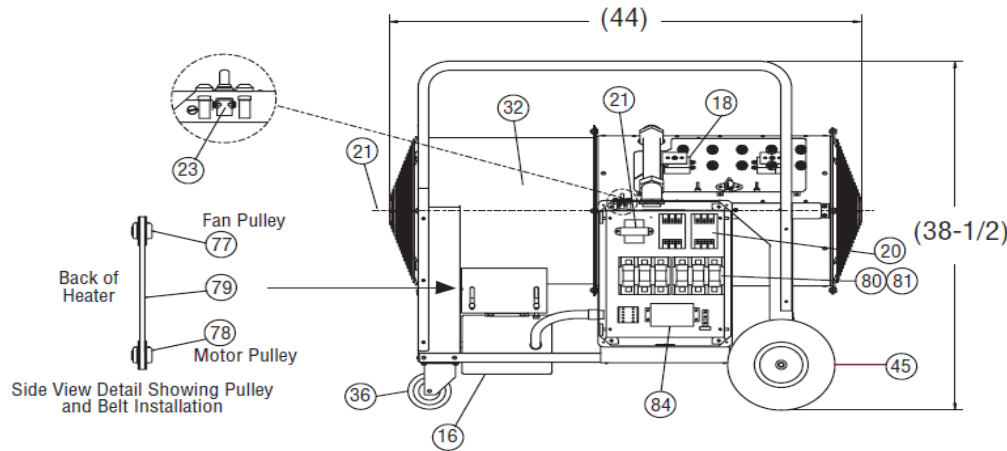
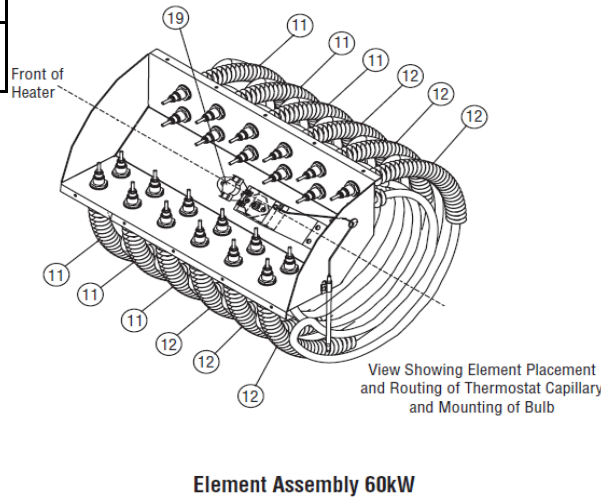
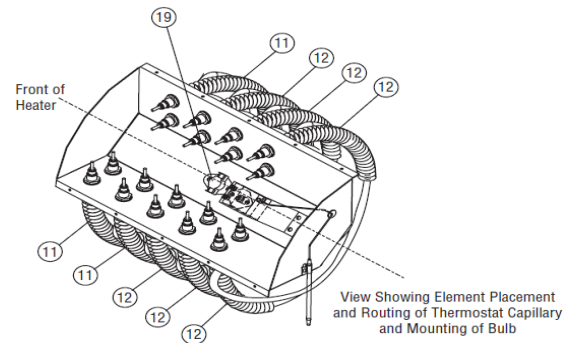
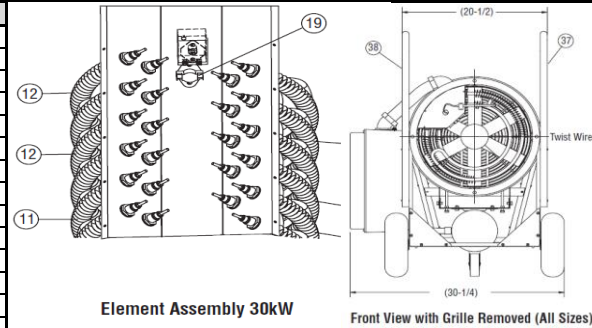

**NOTES:**  
 (#) QUANTITY REQ.  
 \* WIRED DIRECTLY TO CONTACTOR





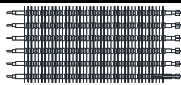
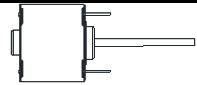
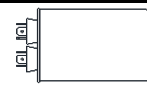



**BPH PLENUM RATED UNIT HEATER**



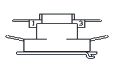
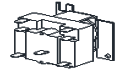

ELEMENT			MOTOR			CAPACITOR		
								
<b>1802-10498-000</b> PRH1381240000 PRH1383240000	<b>1802-10498-004</b> PRH11021240000 PRH11023240000 <b>1802-10498-001</b> PRH152124L000 PRH1521240000 PRH1323240000 <b>1802-10498-002</b> PRH1523240000 PRH171021240000 PRH21023240000 <b>1802-10498-003</b> PRH11083240000 PRH158124L000 PRH1581240000 PRH158324L000 PRH1583240000 PRH21083240000	<b>1802-10498-007</b> PRH1343240000 <b>1802-10498-008</b> PRH11583240000 PRH17581240000 PRH17583240000 <b>1802-10498-009</b> PRH17521240000 PRH17523240000 PRH17523240000 <b>1802-10498-010</b> PRH17571240000 <b>1802-10498-011</b> PRH11543240000 PRH17543240000 PRH21543240000 PRH21043240000	<b>3900-10164-001</b> PRH11043240000 PRH11543240000 PRH1343240000 PRH154324L000 PRH1543240000 PRH17543240000 PRH21043240000 PRH21543240000	<b>3900-10160-003</b> PRH11021240000 PRH11023240000 PRH11083240000 PRH11523240000 PRH1583240000 PRH152124L000 PRH158124L000 PRH158324L000 PRH17521240000 PRH17523240000 PRH17581240000 PRH17583240000 PRH21021240000 PRH21023240000 PRH21083240000 PRH21523240000	<b>3900-2094-001</b> PRH1321240000 PRH1323240000 PRH1381240000 PRH1383240000 PRH1521240000 PRH1523240000 PRH1581240000 PRH1583240000 <b>3900-2095-001</b> PRH1521240000 PRH1571240000 PRH1571240000	<b>1432-0002-001</b> PRH11043240000 PRH11071240000 PRH11543240000 PRH1321240000 PRH1323240000 PRH1343240000 PRH1371240000 PRH1381240000 PRH1383240000 PRH1521240000 PRH1523240000	PRH1543240000 PRH157124L000 PRH1571240000 PRH1583240000 PRH1583240000 PRH17543240000 PRH17571240000 PRH21043240000 PRH21071240000 PRH21543240000	<b>1432-0002-002</b> PRH11021240000 PRH11023240000 PRH11083240000 PRH11523240000 PRH11583240000 PRH152124L000 PRH158124L000 PRH1581240000 PRH158324L000 PRH17521240000 PRH17523240000 PRH17523240000 PRH17581240000 PRH17583240000 PRH21021240000 PRH21023240000 PRH21083240000 PRH21523240000

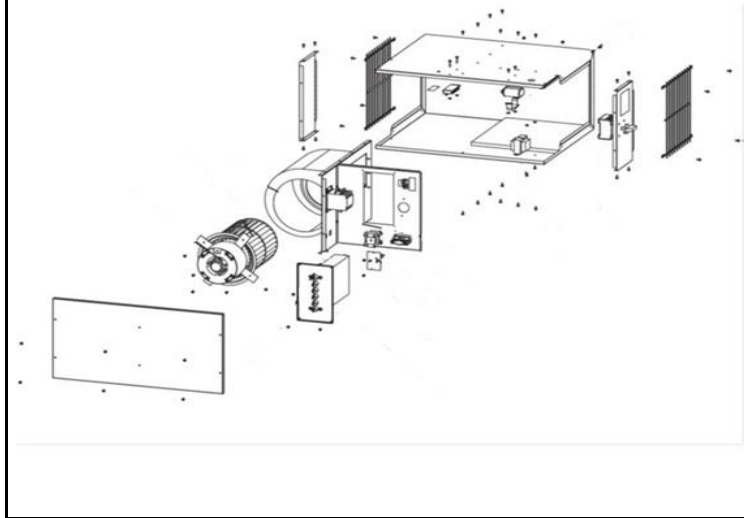
BLOWER ASSEMBLY		LIMIT		GRILLE	
					
<b>1225-10158-000</b> PRH11021240000 PRH11023240000 PRH11043240000 PRH1071240000 PRH11083240000 PRH11523240000 PRH11543240000 PRH1583240000 PRH152124L000 PRH152324L000 PRH154324L000 PRH157124L000 PRH158124L000 PRH158324L000	<b>1225-2022-000</b> PRH1321240000 PRH1323240000 PRH1343240000 PRH1071240000 PRH1381240000 PRH1383240000 PRH1521240000 PRH1523240000 PRH1543240000 PRH1571240000 PRH1581240000 PRH1583240000	<b>1414-2040-001</b> PRH11021240000 PRH11023240000 PRH11043240000 PRH1071240000 PRH11083240000 PRH11523240000 PRH11543240000 PRH1583240000 PRH152124L000 PRH152324L000 PRH154324L000 PRH157124L000 PRH158124L000 PRH158324L000	<b>1414-2040-000</b> PRH1321240000 PRH1323240000 PRH1343240000 PRH1371240000 PRH1381240000 PRH1383240000 PRH1521240000 PRH1523240000 PRH1543240000 PRH1571240000 PRH1581240000 PRH1583240000	<b>2501-10156-800</b> PRH11021240000 PRH11023240000 PRH11043240000 PRH1071240000 PRH11083240000 PRH11523240000 PRH11543240000 PRH1583240000 PRH152124L000 PRH152324L000 PRH154324L000 PRH157124L000 PRH158124L000 PRH158324L000	<b>312056803</b> PRH1321240000 PRH1323240000 PRH1343240000 PRH1371240000 PRH1381240000 PRH1383240000 PRH1521240000 PRH1523240000 PRH1543240000 PRH1571240000 PRH1581240000 PRH1583240000

TRANSFORMER		TERMINAL BLOCK		TIME DELAY RELAY	FAN RELAY	DISCONNECT SW.
						
<b>5814-0003-000</b> PRH11021240000 PRH11023240000 PRH11083240000 PRH11523240000 PRH11583240000 PRH1321240000 PRH1381240000 PRH1383240000 PRH152124L000 PRH154324L000 PRH157124L000 PRH158124L000 PRH158324L000	<b>5814-0003-001</b> PRH11071240000 PRH1157124L000 PRH1571240000 PRH17571240000 <b>5814-0003-002</b> PRH11043240000 PRH11543240000 PRH1343240000 PRH154324L000 PRH1371240000 PRH17543240000 PRH21043240000 PRH21543240000	<b>480106001</b> PRH11021240000 PRH11023240000 PRH11043240000 PRH1071240000 PRH11083240000 PRH11523240000 PRH11543240000 PRH11583240000 PRH1321240000 PRH1323240000 PRH1343240000 PRH1371240000 PRH1381240000 PRH1383240000 PRH1521240000	<b>480106002</b> PRH152324L000 PRH154324L000 PRH157124L000 PRH158124L000 PRH1581240000 PRH158324L000 PRH1583240000 PRH17521240000 PRH17523240000 PRH17543240000 PRH17571240000 PRH17581240000 PRH17583240000	<b>410171001</b> ALL MODELS <b>CONTACTOR RELAY</b> PRH11021240000 PRH11043240000 PRH1071240000 PRH1083240000 PRH11523240000 PRH11543240000 PRH121543240000 <b>5018-0005-004</b> ALL MODELS	<b>5018-2024-000</b> ALL MODELS 	<b>5216-2036-000</b> ALL MODELS





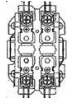
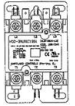
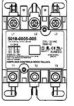
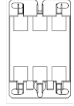
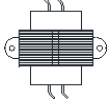





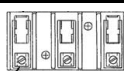

**HUHAA SERIES**

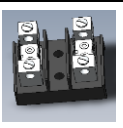
ELEMENT				MOTOR		
<b>QUANTITY OF ELEMENTS</b> 3 THRU 10KW (3) 15 THRU 30KW (6) 40 & 50KW (9)						
<b>1802-0087-024</b> HUHAA320FC	<b>1802-0087-031</b> HUHAA720FC HUHAA1024FC	<b>1802-0087-037</b> HUHAA1524FC HUHAA2024FC	<b>1802-0087-018</b> HUHAA3024FC <b>1802-0087-019</b> HUHAA3048AFC	<b>3900-2002-506</b> HUHAA320FC HUHAA324FC HUHAA520FC HUHAA524FC	<b>3900-0347-005</b> HUHAA748FC HUHAA1048FC <b>3900-0361-500</b> HUHAA1520FC HUHAA1524FC	<b>3900-0363-500</b> HUHAA2548AFC HUHAA3048AFC <b>3900-0350-000</b> HUHAA5020FC <b>3900-0350-000</b> HUHAA4024FC HUHAA5024FC
<b>1802-0087-000</b> HUHAA324FC	<b>1802-0087-006</b> HUHAA724FC	<b>1802-0087-012</b> HUHAA1524FC	<b>1802-0087-020</b> HUHAA4024FC	<b>3900-2002-507</b> HUHAA327FC HUHAA527FC	<b>3900-0361-501</b> HUHAA1548FC	<b>3900-0350-001</b> HUHAA4048FC HUHAA5048FC
<b>1802-0087-001</b> HUHAA327FC	<b>1802-0087-007</b> HUHAA727FC	<b>1802-0087-008</b> HUHAA1548FC	<b>1802-0087-021</b> HUHAA4048FC	<b>3900-2005-000</b> HUHAA348FC HUHAA548FC	<b>3900-0362-002</b> HUHAA2020FC <b>3900-0362-000</b> HUHAA2024FC	
<b>1802-0087-002</b> HUHAA348FC	<b>1802-0087-008</b> HUHAA748FC	<b>1802-0087-026</b> HUHAA2020FC	<b>1802-0087-030</b> HUHAA5020FC	<b>3900-2014-004</b> HUHAA720FC HUHAA724FC HUHAA727FC HUHAA1020FC HUHAA1024FC	<b>3900-0362-001</b> HUHAA2048FC <b>3900-0364-000</b> HUHAA2524FC HUHAA3020FC HUHAA3024FC	
<b>1802-0087-034</b> HUHAA520FC	<b>1802-0087-036</b> HUHAA1020FC	<b>1802-0087-016</b> HUHAA2524FC	<b>1802-0087-022</b> HUHAA5024FC	<b>1802-0087-023</b> HUHAA5048FC		
<b>1802-0087-035</b> HUHAA524FC	<b>1802-0087-010</b> HUHAA1027FC	<b>1802-0087-017</b> HUHAA2548AFC				
<b>1802-0087-004</b> HUHAA527FC	<b>1802-0087-011</b> HUHAA1048FC HUHAA2048FC	<b>1802-0087-028</b> HUHAA3020FC				
<b>1802-0087-005</b> HUHAA548FC						
FAN BLADE				PROTECTOR LIMIT		FAN DELAY
						
<b>1210-2000-000</b> HUHAA320FC HUHAA324FC HUHAA327FC HUHAA348FC HUHAA520FC HUHAA524FC HUHAA527FC HUHAA548FC	<b>1210-0090-000</b> HUHAA720FC HUHAA724FC HUHAA727FC HUHAA748FC HUHAA1020FC HUHAA1024FC HUHAA1027FC HUHAA1048FC <b>1210-0090-001</b> HUHAA1520FC HUHAA1524FC HUHAA1548FC <b>1210-0096-000</b> HUHAA2020FC HUHAA2024FC HUHAA2048FC	<b>1210-0098-000</b> HUHAA2524FC HUHAA2548AFC HUHAA3020FC HUHAA3024FC HUHAA3048AFC <b>1210-11004-000</b> HUHAA4024FC HUHAA4048FC HUHAA5020FC HUHAA5024FC HUHAA5048FC	<b>4520-0011-000</b> HUHAA320FC HUHAA324FC HUHAA327FC HUHAA348FC HUHAA520FC HUHAA524FC HUHAA527FC HUHAA548FC	<b>4520-0011-001</b> HUHAA720FC HUHAA724FC HUHAA727FC HUHAA748FC HUHAA1020FC HUHAA1024FC HUHAA1027FC HUHAA1048FC HUHAA1520FC HUHAA1524FC HUHAA1548FC HUHAA2020FC HUHAA2024FC HUHAA2048FC	<b>4520-0011-002</b> HUHAA2524FC HUHAA2548AFC HUHAA3020FC HUHAA3024FC HUHAA3048AFC HUHAA4024FC HUHAA4048FC HUHAA5020FC HUHAA5024FC HUHAA5048FC	<b>4520-0010-000</b> ALL MODELS
RELAY				POWER TR		
						
<b>30 AMP</b> <b>5018-0003-000</b> HUHAA727FC HUHAA1027FC	<b>35 AMP</b> <b>5018-0004-100</b> HUHAA348FC HUHAA548FC HUHAA748FC HUHAA1048FC HUHAA1548FC	<b>40 AMP</b> <b>5018-0005-004</b> HUHAA724FC HUHAA720FC HUHAA1024FC HUHAA1020FC HUHAA1524FC HUHAA1520FC HUHAA2048FC HUHAA2020FC HUHAA2524FC HUHAA2548AFC HUHAA3024FC HUHAA3048AFC HUHAA4024FC HUHAA4048FC HUHAA5024FC	<b>50 AMP</b> <b>5018-0006-000</b> HUHAA2024FC HUHAA3020FC HUHAA5020FC HUHAA5048FC <b>40 AMP</b> <b>5018-11562-004</b> HUHAA4024FC HUHAA5024FC HUHAA5020FC	<b>240/208V PR TO 24V SEC</b> <b>5814-0003-000</b> HUHAA720FC HUHAA724FC HUHAA1020FC HUHAA1024FC HUHAA1520FC HUHAA1524FC HUHAA2020FC HUHAA2024FC HUHAA2524FC HUHAA3020FC HUHAA3024FC <b>277V PR TO 24V SEC</b> <b>5814-0003-001</b> HUHAA727FC HUHAA1027FC	<b>480V PR TO 24V SEC</b> <b>5814-0003-002</b> HUHAA348FC HUHAA548FC HUHAA748FC HUHAA1048FC HUHAA1548FC HUHAA2048FC HUHAA2548AFC HUHAA3048AFC HUHAA4048FC HUHAA5048FC	<b>240V/208V PR TO 24V SEC</b> <b>490026007</b> HUHAA4024FC HUHAA5020FC HUHAA5024FC

PRO AND PRO-SSP CONTINUE NEXT PAGE

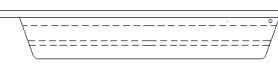



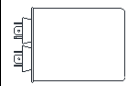



**HUHAA CONTINUED**

CONTROL BOARD		POWER BLOCK		FUSE BLOCK	FUSE
					
<b>5823-0001-000</b> HUHAA320FC HUHAA324FC HUHAA327FC HUHAA520FC HUHAA524FC HUHAA527FC	<b>5823-0002-000</b> HUHAA348FC HUHAA548FC HUHAA724FC HUHAA727FC HUHAA748FC HUHAA1020FC HUHAA1024FC HUHAA1027FC HUHAA1048FC HUHAA1520FC HUHAA1524FC HUHAA1548FC	<b>5823-0004-000</b> HUHAA320FC HUHAA324FC HUHAA327FC HUHAA348FC HUHAA520FC HUHAA524FC HUHAA527FC HUHAA548FC HUHAA720FC	<b>5823-0004-001</b> HUHAA724FC HUHAA727FC HUHAA748FC HUHAA1020FC HUHAA1024FC HUHAA1027FC HUHAA1048FC HUHAA1548FC HUHAA2048FC	<b>2025-0002-000</b> HUHAA1520FC HUHAA2020FC <b>480030004</b> HUHAA2524FC HUHAA3020FC HUHAA3024FC HUHAA4024FC HUHAA5020FC HUHAA5024FC	<b>2019-0007-010</b> HUHAA1520FC <b>2019-0007-008</b> HUHAA2020FC <b>2019-7008-077</b> HUHAA2524FC <b>2019-7008-080</b> HUHAA3020FC HUHAA5020FC <b>2019-7008-079</b> HUHAA3024FC HUHAA5024FC <b>2019-7008-078</b> HUHAA4024FC <b>2019-7002-008</b> HUHAA5048FC <b>2019-7002-012</b> HUHAA5048FC
				<b>5823-0004-003</b> HUHAA1520FC HUHAA3024FC	<b>2025-0001-000</b> HUHAA5048FC
		<b>7.5-10KW 208 &amp; 240V MODELS AFTER JAN 2024</b> <b>5823-11012-000</b>		<b>5823-0005-000</b> HUHAA3020FC HUHAA4024FC HUHAA5020FC HUHAA5024FC	<b>2025-7004-000</b> HUHAA5048FC



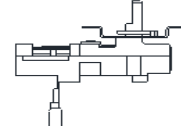
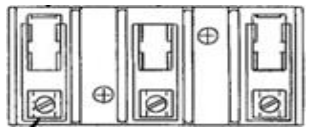
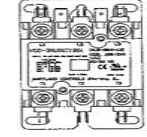
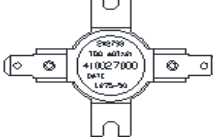
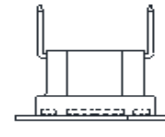
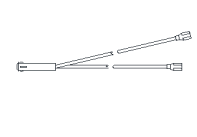







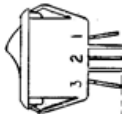

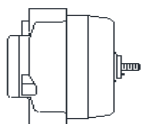
LOUVERS			LOUVER SPRING	HI/LOW SW.	CAPACITOR	
<b>QUANTITY</b> <b>38.5KW (5)</b> <b>7 THRU 20KW (6)</b> <b>25 THRU 50KW (9)</b>						
<b>3503-2004-106</b> HUHAA320FC HUHAA324FC HUHAA327FC HUHAA348FC HUHAA520FC HUHAA524FC HUHAA527FC HUHAA548FC	<b>3503-2004-107</b> HUHAA720FC HUHAA724FC HUHAA727FC HUHAA748FC HUHAA1020FC HUHAA1024FC HUHAA1027FC HUHAA1048FC HUHAA1520FC HUHAA1524FC HUHAA1548FC HUHAA2020FC HUHAA2024FC HUHAA2048FC	<b>3503-2004-108</b> HUHAA2524FC HUHAA2548AFC HUHAA3020FC HUHAA3024FC HUHAA3048AFC HUHAA4024FC HUHAA4048FC HUHAA5020FC HUHAA5024FC HUHAA5048FC	<b>5208-7005-001</b> ALL MODELS	<b>5216-2053-000</b> HUHAA2524FC HUHAA2548AFC HUHAA3020FC HUHAA3024FC HUHAA3048AFC HUHAA4024FC HUHAA4048FC HUHAA5020FC HUHAA5024FC HUHAA5048FC	<b>1432-0002-003</b> HUHAA2020FC HUHAA2024FC HUHAA2048FC HUHAA2524FC <b>1432-11004-000</b> HUHAA2548AFC HUHAA3048AFC <b>1432-0002-001</b> HUHAA3020FC <b>1432-0002-004</b> HUHAA4024FC HUHAA4048FC HUHAA5020FC HUHAA5024FC HUHAA5048FC	<b>THERMOSTAT (ASSM INCLUDES KNOB)</b> <b>UHMT1 (ASSEMBLY 1-POLE)</b> 5813-0036-000 THERMOSTAT 3301-2020-006 KNOB <b>UHMT2 (ASSEMBLY 2-STAGE)</b> 5813-0035-000 THERMOSTAT 3301-2020-006 KNOB <b>UHMT1-S (ASSEMBLY 1-POLE)</b> 5813-0038-003 THERMOSTAT 3301-2020-006 KNOB

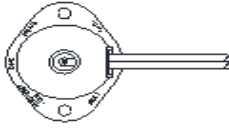
HUHAA PRO SERIES				
SAME PARTS AS STOCK MODELS WITH ADDED DISCONNECT SWITCH, THERMOSTAT, & 24V CONTROL CIRCUIT				
MODEL	DISCONNECT SWITCH	THERMOSTAT	TRANSFORMER	RELAY
HUHAA320FC-PRO	5216-2036-000	UHMT1	5814-0003-000	5018-0003-000
HUHAA324FC-PRO	5216-2036-000	UHMT1	5814-0003-000	5018-0003-000
HUHAA348FC-PRO	5216-2036-000	UHMT1	5814-0003-002	5018-0004-100
HUHAA520FC-PRO	5216-2036-000	UHMT1	5814-0003-000	5018-0003-000
HUHAA524FC-PRO	5216-2036-000	UHMT1	5814-0003-000	5018-0003-000
HUHAA548FC-PRO	5216-2036-000	UHMT1	5814-0003-002	5018-0004-100
HUHAA720FC-PRO	5216-2039-000	UHMT1	5814-0003-000	5018-0003-000
HUHAA724FC-PRO	5216-2039-000	UHMT1	5814-0003-000	5018-0003-000
HUHAA748FC-PRO	5216-2036-000	UHMT1	5814-0003-002	5018-0004-100
HUHAA1020FC-PRO	5216-2039-000	UHMT1	5814-0003-000	5018-0004-100
HUHAA1024FC-PRO	5216-2039-000	UHMT1	5814-0003-000	5018-0003-000
HUHAA1048FC-PRO	5216-2036-000	UHMT1	5814-0003-002	5018-0004-100
MODEL	DISCONNECT SWITCH	THERMOSTAT	TRANSFORMER	RELAY
HUHAA320FCPRSS	5216-2036-000	1414-11050-000	5814-0003-000	5018-0003-000
HUHAA324FCPRSS	5216-2036-000	1414-11050-000	5814-0003-000	5018-0003-000
HUHAA348FCPRSS	5216-2036-000	1414-11050-000	5814-0003-002	5018-0004-100
HUHAA520FCPRSS	5216-2036-000	1414-11050-000	5814-0003-000	5018-0003-000
HUHAA524FCPRSS	5216-2036-000	1414-11050-000	5814-0003-000	5018-0003-000
HUHAA548FCPRSS	5216-2036-000	1414-11050-000	5814-0003-002	5018-0004-100
HUHAA720FCPRSS	5216-2039-000	1414-11050-000	5814-0003-000	5018-0003-000
HUHAA724FCPRSS	5216-2039-000	1414-11050-000	5814-0003-000	5018-0003-000
HUHAA748FCPRSS	5216-2036-000	1414-11050-000	5814-0003-002	5018-0004-100
HUHAA1020FCPRSS	5216-2039-000	1414-11050-000	5814-0003-000	5018-0004-100
HUHAA1024FCPRSS	5216-2039-000	1414-11050-000	5814-0003-000	5018-0003-000
HUHAA1048FCPRSS	5216-2036-000	1414-11050-000	5814-0003-002	5018-0004-100

## HUH524TA & HUH724ST SERIES

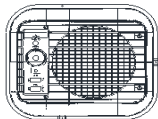
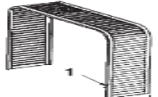
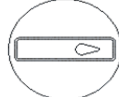
ELEMENT		MOTOR	FAN BLADE	KNOB	THERMOSTAT
					
<b>302006807</b> HUH524TA HUH524TAB HUH524TAC	<b>302006810</b> UH724ST UH724STA	<b>3900-2008-000</b> HUH524TA HUH524TAB HUH524TAC UH724ST UH724STA	<b>1210-2017-000</b> HUH524TA HUH524TAB HUH524TAC UH724ST UH724STA	<b>3301-2014-006</b> HUH524TA HUH524TAB HUH524TAC UH724ST UH724STA	<b>5813-2050-000</b> HUH524TA HUH524TAB HUH524TAC UH724ST UH724STA
POWER BLOCK		RELAY	HI LIMIT	FAN DELAY	LIGHT
					
<b>5823-0004-005</b> HUH524TA HUH524TAB HUH524TAC	<b>5823-0004-000</b> UH724ST UH724STA	<b>5018-11006-000</b> UH724ST UH724STA	<b>410027000</b> HUH524TA HUH524TAB HUH524TAC UH724ST UH724STA	<b>410148000</b> HUH524TA HUH524TAB HUH524TAC UH724ST UH724STA	<b>3510-2017-003</b> HUH524TAC UH724STA
LOUVERS		LOUVER SPRING	MT. BRACKET		
					
<b>3503-2004-109</b> HUH524TA HUH524TAB HUH524TAC	UH724ST UH724STA	<b>5208-7005-001</b> HUH524TA HUH524TAB HUH524TAC UH724ST UH724STA	<b>310876001</b> HUH524TA HUH524TAB HUH524TAC UH724ST UH724STA		

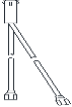
**QPH4A & PH5 SERIES**

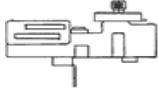
ROCKER SWITCH (2 REQ)		FAN BLADE		ELEMENT (3 REQ)		MOTOR					
											
<b>S99814893A000</b> PH5 PH5HW PH5HWA PH5HWAB PH5HWAC PH5HWAD PH4A PH4AB NPH4AB NPH4ABA		<b>1210-2000-000</b> PH5 PH5HW PH5HWA PH5HWAB PH5HWAC PH5HWAD PH4 PH4A		<b>1210-2000-001</b> PH4AB NPH4AB NPH4ABA		<b>1802-0087-032</b> PH5 PH5HW PH5HWA PH5HWAB PH5HWAC PH5HWAD		<b>1802-0087-038</b> PH4 PH4A PH4AB NPH4AB NPH4ABA		<b>3900-2002-506</b> PH5 PH5HW PH5HWA PH5HWAB PH5HWAC PH5HWAD PH4 PH4A PH4AB NPH4AB NPH4ABA	
FAN DELAY		MANUAL RESET		LIMIT		BUZZER					
											
<b>4520-0010-000</b> PH5HWAC PH5HWAD		<b>4520-2017-000</b> PH5HWA PH5HWAB PH4A		<b>4520-11004-000</b> PH4AB NPH4AB		<b>4520-11004-002</b> PH5HWAC PH5HWAD NPH4ABA		<b>4520-0011-000</b> PH5 PH5HW PH4		<b>2714-11001-000</b> PH5HWAD	
STAND	CONTROL COVER	GRILLE	GUARD	T'STAT KNOB	STAND KNOB (2 REQ)						
											
<b>5210-2000-002</b> PH5HWAB PH5HWAC PH5HWAD PH4A PH4AB NPH4AB NPH4ABA		<b>1402-0336-000</b> PH5 PH5HW PH5HWA PH5HWAB PH5HWAC PH5HWAD PH4 PH4AB NPH4AB NPH4ABA		<b>1402-2154-001</b> PH5HWAB PH5HWAC PH5HWAD PH4AB NPH4AB NPH4ABA		<b>2504-0011-001</b> PH5 PH5HW PH5HWA PH5HWAB PH5HWAC PH5HWAD PH4 PH4AB NPH4AB NPH4ABA		<b>3301-2012-001</b> PH5HWAB PH5HWAC PH5HWAD PH4AB NPH4AB NPH4ABA		<b>3301-2018-000</b> PH5HWA PH5HWAB PH5HWAC PH5HWAD PH4AB NPH4AB NPH4ABA	
LIGHT	CORD	THERMOSTAT									
											
<b>3510-2007-000</b> PH5HWA PH5HWAB PH5HWAC PH5HWAD		<b>1420-2028-000</b> PH4AB <b>1420-11012-000</b> NPH4AB NPH4ABA		<b>5813-2018-000</b> PH5HWA PH5HWAB PH5HWAC PH5HWAD PH4A PH4AB NPH4AB NPH4ABA		<b>5813-0047-000</b> PH5 PH5HW PH4					

**WD SERIES WASHDOWN UNIT HEATER**

MOTOR		BLADE		ELEMENT	
				QUANTITY REQ 2KW (2) 3 THRU 15KW (3) 20 THRU 39KW (6)	
208-240/480V 2KW-10KW MODELS 277V 3KW-10KW MODELS 120V 2-3KW MODELS 208-240/480V 12.5KW-39KW MODELS		10KW MODELS 10KW MODELS WITH EPOXY COATING 2-7.5KW MODELS WITH EPOXY COATING 12.5KW MODELS 15-39KW MODELS 12.5KW MODELS WITH EPOXY COATING 15-39KW MODELS WITH EPOXY COATING		2-3KW 120V 2-3KW 208V 2-3KW 240V 3KW 277V 3KW 480V 5KW 208V 5KW 240V 5KW 277V 5KW 480V 3PH 5KW 480V 1PH 7.5KW 208V 7.5KW 240V 7.5KW 277V 7.5KW 480V	
3900-11036-000 3900-11036-001 3900-11036-002 3900-11037-000		1210-11007-000 1210-11007-002 1210-11007-001 1210-11007-003 1210-11008-000 1210-11008-001 1210-11008-002 1210-11008-003		1802-11012-001 1802-11012-002 1802-11012-003 1802-11012-004 1802-11012-005 1802-11012-006 1802-11012-007 1802-11012-007 1802-11012-008 1802-11012-011 1802-11012-012 1802-11012-009 1802-11012-008	
2-10KW 12.5-39KW		4520-11013-000 4520-11013-001		10KW 208V 10KW 240V 10KW 277V 10KW 480V 12.5KW 208V 12.5KW 240V 12.5KW 480V 15KW 208V 15KW 240V 20KW 240V 25KW 208V 30KW 240V 15 & 30KW 480V 20KW 480V 39KW 480V	
WALL/CEILING BRK 2-10KW MODELS 12.5-39KW MODELS		HAT BRACKET 2-10KW MODELS 12.5-39KW MODELS		1016-11218-000 1016-11218-001	

FAN RELAY		CONTACTOR 50A		TRANSFORMER	

5018-11005-000		5018-11005-001		5018-0006-000		5018-0006-001	
BWD02112	BWD07812	BWD25232	BWD05431	BWD02112	BWD07812	BWD25232	BWD05431
BWD02212	BWD07832	BWD25432	BWD07831	BWD02212	BWD07832	BWD25432	BWD07831
BWD02812	BWD10112	BWD25832	BWD30431	BWD02812	BWD10112	BWD25832	BWD30431
BWD03112	BWD10232	BWD30232		BWD03112	BWD10232	BWD30232	
BWD03212	BWD10412	BWD30432		BWD03212	BWD10412	BWD30432	
BWD03232	BWD10432	BWD30832		BWD03232	BWD10432	BWD30832	
BWD03432	BWD10712	BWD39432		BWD03432	BWD10712	BWD39432	
BWD03712	BWD10832			BWD03712	BWD10832		
BWD03812	BWD12212			BWD03812	BWD12212		
BWD03832	BWD12232			BWD03832	BWD12232		
BWD05212	BWD12432			BWD05212	BWD12432		
BWD05232	BWD12812			BWD05232	BWD12812		
BWD05412	BWD12832			BWD05412	BWD12832		
BWD05432	BWD15212			BWD05432	BWD15212		
BWD05712	BWD15332			BWD05712	BWD15332		
BWD05812	BWD15412			BWD05812	BWD15412		
BWD05832	BWD15432			BWD05832	BWD15432		
BWD07212	BWD15812			BWD07212	BWD15812		
BWD07232	BWD15832			BWD07232	BWD15832		
BWD07412	BWD20232			BWD07412	BWD20232		
BWD07432	BWD20412			BWD07432	BWD20412		
BWD07712	BWD20432			BWD07712	BWD20432		

GRILLE INLET		GRILLE OUTLET		STRAIGHT FITTING		SILICONE SEAL	
2-10KW MODELS 12.5-39KW MODELS		2-10KW MODELS 12.5-39KW MODELS		2504-11019-001 2504-11021-001		PICTURE NOT AVAILABLE	
2504-11018-000 2504-11020-000				1213-2009-000 ALL MODELS		5250-2001-000 ALL MODELS	

CAPACITOR		POWER BLOCK	







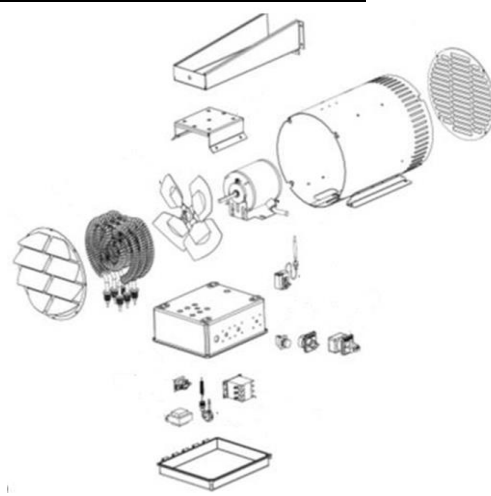

1432-0002-001		1432-0002-003		1432-0002-004		5823-0004-002		480034002	
BWD02112	BWD05812	BWD12212	BWD02032	BWD02112	BWD07712	BWD02112	BWD07712	BWD12212	BWD12812
BWD02212	BWD05832	BWD12232	BWD02042	BWD02212	BWD07812	BWD02212	BWD07812	BWD12812	BWD15212
BWD02812	BWD07212	BWD12432	BWD02532	BWD02812	BWD10212	BWD02812	BWD10212	BWD15212	BWD15812
BWD03112	BWD07232	BWD12812	BWD02532	BWD03112	BWD10232	BWD03112	BWD10232	BWD15812	BWD20232
BWD03212	BWD07412	BWD12832	BWD02532	BWD03212	BWD10412	BWD03212	BWD10412	BWD20232	BWD25232
BWD03232	BWD07432	BWD15212	BWD02532	BWD03232	BWD10712	BWD03232	BWD10712	BWD25232	BWD25832
BWD03432	BWD07812	BWD15332	BWD03032	BWD03432	BWD10832	BWD03432	BWD10832	BWD30232	BWD30832
BWD03812	BWD07832	BWD15412	BWD03032	BWD03812	BWD12232	BWD03812	BWD12232		
BWD03832	BWD10212	BWD15432	BWD03032	BWD03832	BWD12432	BWD03832	BWD12432		
BWD05212	BWD10232	BWD15812	BWD03942	BWD05212	BWD12832	BWD05212	BWD12832		
BWD05232	BWD10412	BWD15832		BWD05232	BWD15212	BWD05232	BWD15212		
BWD05412	BWD10432			BWD05412	BWD15332	BWD05412	BWD15332		
BWD05432	BWD10832			BWD05432	BWD15412	BWD05432	BWD15412		
					BWD05712		BWD05712		
					BWD05812		BWD05812		
					BWD05832		BWD05832		
					BWD07212		BWD07212		
					BWD07232		BWD07232		
					BWD07412		BWD07412		
					BWD07432		BWD07432		

PART		GASKET		KNOB	
THERMOSTAT		5206-11009-000		3301-11010-000	
SM/MD UNITS		5206-11010-000			
Lrg UNITS					
PILOT LIGHT		N/A		N/A	
120V CONTROL					
24V CONTROL					
MODE SWITCH		5206-11009-000		PART OF SW. ASSM	
SM/MD UNITS					
Lrg UNITS					
DISCONNECT SWITCH		5206-11009-000		PART OF SW. ASSM	
40AMP					
60AMP					
100AMP					
125AMP					
MANUAL RESET		N/A		N/A	
SM/MD UNITS					
Lrg UNITS					
EPOXY COATING		CONTACT FACTORY			

**Factory Installed Accessories**

CATALOG NUMBER	DESCRIPTION
T	Thermostat
L	Pilot Light
S	Mode/Selector Switch
D	Disconnect Switch
E	Monel Element*
M	Manual Reset
P	Epoxy Coating



UCJ															
ELEMENT				LINEAR LIMIT			TR. RELAY								
															
1802-11021-003 J400B	1802-2044-011 J750B	1802-2044-014 J1007B	1802-2044-228 J1503B	4520-2018-000 J400B	4520-2018-003 J1000B	4520-2018-005 J1500B	5018-11003-003 J503B	410043007 J1006B							
1802-11021-001 J404B	1802-2044-210 J753B	1802-2044-016 J1008B	1802-2044-027 J1504B	J404B	J1003B	J1503B	J753B	J1256B							
1802-11021-000 J407B	1802-2044-009 J754B	1802-2044-023 J1250B	1802-2044-229 J1506B	J407B	J1004B	J1504B	J1003B	J1506B							
1802-11021-002 J408B	1802-2044-008 J757B	1802-2044-222 J1253B	1802-2044-026 J1507B	4520-2018-001 J408B	J1006B	J1506B	J1253B	J2006B							
1802-2044-043 J500B	1802-2044-010 J758B	1802-2044-021 J1254B	1802-2044-028 J1508B	4520-2018-001 J500B	4520-2018-004 J1250B	4520-2018-006 J2003B	J1503B								
1802-2044-202 J503B	1802-2044-017 J1000B	1802-2044-223 J1256B	1802-2044-234 J2003B	J503B	J1253B	J2004B	J1006B								
1802-2044-041 J504B	1802-2044-216 J1003B	1802-2044-020 J1257B	1802-2044-033 J2004B	4520-2018-002 J750B	J1254B	J2006B	J1256B								
1802-2044-040 J507B	1802-2044-015 J1004B	1802-2044-022 J1258B	1802-2044-235 J2006B	J753B	J1257B	J2007B	J2008B								
1802-2044-042 J508B	1802-2044-217 J1006B	1802-2044-029 J1500B	1802-2044-032 J2007B	J754B	J1258B										
			1802-2044-034 J2008B	J757B											
				J758B											
SWITCH		FRONT COVER				CONTROL COVER	THERMOSTAT								
															
5216-11007-000 J400B J404B J407B J408B J500B J504B J507B J508B J750B J754B J757B J758B J1000B J1004B		5216-2053-000 J503B J753B J1003B J1250B J1257B J1258B J1500B J1504B J1507B J1508B J2003B J2006B		1402-2192-006 J400B J404B J407B J408B 1402-2192-001 J500B J503B J504B J507B J508B 1402-2192-002 J750B J753B J754B J757B J758B		1402-2192-003 J1000B J1003B J1004B J1006B J1007B J1008B 1402-2192-004 J1250B J1253B J1254B J1256B J1257B J1258B		1402-2192-005 J1500B J1503B J1504B J1506B J1507B J1508B 1402-2192-007 J2003B J2004B J2006B J2007B J2008B		1402-11020-000 ALL MODELS			5813-11014-000 ALL MODELS		
															

**ASL SERIES**



DISCRPTION	PART NUMBERS					
	120V	208V	240V	277V	347V	600V
<b>*ELEMENT (100 WATTS/FT)</b>						
<b>28" HEATER</b>	1802-2001-047	1802-2001-048	1802-2001-049	NA	NA	NA
3'	1802-2001-053	1802-2001-054	1802-2001-055	1802-2001-056	NA	NA
4'	1802-2001-059	1802-2001-060	1802-2001-061	1802-2001-062	1802-2001-232	NA
5'	1802-2001-065	1802-2001-066	1802-2001-067	1802-2001-068	1802-2001-242	NA
6'	1802-2001-071	1802-2001-072	1802-2001-073	1802-2001-074	1802-2001-252	1802-2001-253
8'	NA	1802-2001-077	1802-2001-078	1802-2001-079	1802-2001-262	1802-2001-263
10'	NA	1802-2001-081	1802-2001-082	1802-2001-083	1802-2001-272	1802-2001-273
<b>*ELEMENT (125 WATTS/FT)</b>						
<b>28" HEATER</b>	1802-2001-085	1802-2001-086	1802-2001-048	1802-2001-049	NA	NA
3'	1802-2001-087	1802-2001-088	1802-2001-054	1802-2001-055	1802-2001-220	NA
4'	1802-2001-089	1802-2001-090	1802-2001-060	1802-2001-061	1802-2001-230	NA
5'	1802-2001-091	1802-2001-092	1802-2001-066	1802-2001-067	1802-2001-240	1802-2001-241
6'	1802-2001-093	1802-2001-094	1802-2001-072	1802-2001-073	1802-2001-250	1802-2001-251
8'	NA	1802-2001-095	1802-2001-077	1802-2001-078	1802-2001-260	1802-2001-261
10'	NA	1802-2001-096	1802-2001-081	1802-2001-082	1802-2001-270	1802-2001-271
<b>*ELEMENT (150 WATTS/FT)</b>						
<b>28" HEATER</b>	1802-2001-051	1802-2001-001	1802-2001-000	1802-2001-052	NA	NA
3'	1802-2001-057	1802-2001-007	1802-2001-006	1802-2001-058	1802-2001-218	NA
4'	1802-2001-063	1802-2001-013	1802-2001-012	1802-2001-064	1802-2001-228	NA
5'	1802-2001-069	1802-2001-019	1802-2001-018	1802-2001-070	1802-2001-238	1802-2001-239
6'	1802-2001-075	1802-2001-025	1802-2001-024	1802-2001-076	1802-2001-248	1802-2001-249
8'	NA	1802-2001-031	1802-2001-030	1802-2001-080	1802-2001-258	1802-2001-259
10'	NA	1802-2001-035	1802-2001-034	1802-2001-084	1802-2001-268	1802-2001-269
<b>*ELEMENT (188 WATTS/FT)</b>						
<b>28" HEATER</b>	1802-2001-005	1802-2001-002	1802-2001-001	1802-2001-000	NA	NA
3'	1802-2001-011	1802-2001-008	1802-2001-007	1802-2001-006	1802-2001-216	NA
4'	1802-2001-017	1802-2001-014	1802-2001-013	1802-2001-012	1802-2001-226	1802-2001-227
5'	1802-2001-023	1802-2001-020	1802-2001-019	1802-2001-018	1802-2001-236	1802-2001-237
6'	1802-2001-029	1802-2001-026	1802-2001-025	1802-2001-024	1802-2001-246	1802-2001-247
8'	NA	1802-2001-032	1802-2001-031	1802-2001-030	1802-2001-256	1802-2001-257
10'	NA	1802-2001-036	1802-2001-035	1802-2001-034	1802-2001-266	1802-2001-267
<b>*ELEMENT (250 WATTS/FT)</b>						
<b>28" HEATER</b>	1802-2001-004	1802-2001-003	1802-2001-002	1802-2001-001	1802-2001-202	NA
3'	1802-2001-010	1802-2001-009	1802-2001-008	1802-2001-007	1802-2001-214	NA
4'	1802-2001-016	1802-2001-015	1802-2001-014	1802-2001-013	1802-2001-224	1802-2001-225
5'	1802-2001-022	1802-2001-021	1802-2001-020	1802-2001-019	1802-2001-234	1802-2001-235
6'	1802-2001-028	1802-2001-027	1802-2001-026	1802-2001-025	1802-2001-244	1802-2001-245
8'	NA	1802-2001-033	1802-2001-032	1802-2001-031	1802-2001-254	1802-2001-255
10'	NA	1802-2001-037	1802-2001-036	1802-2001-035	1802-2001-264	1802-2001-265
<p>* 1, 2 OR 3 ELEMENTS MAY BE REQUIRED. VOLTAGE AND WATTAGE ARE STAMPED ON END OF ELEMENTS. DIVIDE THE WATTAGE BY THE HEATER LENGTH (FEET) TO DETERMINE WATTS/FOOT OF ELEMENT. THEN USE THIS DATA TO DETERMINE PART NUMBER OF HEATING ELEMENT.</p>						

DISCRPTION	PART NUMBERS					
	120V	208V	240V	277V	347V	600V
<b>LINEAR LIMIT</b>						
<b>28" HEATER</b>	4520-0007-007	4520-0007-007	4520-0007-007	4520-0007-007	4520-0007-007	4520-0007-007
3'	4520-0007-008	4520-0007-008	4520-0007-008	4520-0007-008	4520-0007-008	4520-0007-008
4'	4520-0007-009	4520-0007-009	4520-0007-009	4520-0007-009	4520-0007-009	4520-0007-009
5'	4520-0007-010	4520-0007-010	4520-0007-010	4520-0007-010	4520-0007-010	4520-0007-010
6'	4520-0007-011	4520-0007-011	4520-0007-011	4520-0007-011	4520-0007-011	4520-0007-011
8'	NA	4520-0007-012	4520-0007-012	4520-0007-012	4520-0007-012	4520-0007-012
10'	NA	4520-0007-013	4520-0007-013	4520-0007-013	4520-0007-013	4520-0007-013
<b>DISCONNECT SW.</b>	<b>THERMOSTAT</b>	<b>TRANSFORMER</b>		<b>POWER RELAY</b>		
410170001	<b>2-STAGE</b> 5813-0023-000 <b>SINGLE POLE</b> 5813-11014-000	<b>120V</b> 5018-11003-000 <b>208/240V</b> 5018-11003-001	<b>277V</b> 5018-11003-002 <b>347V</b> 5018-11003-003	<b>24V</b> 410171001 <b>120V</b> 410171002	<b>208/240V/277V</b> 410171003	



**BDBSL SERIES**

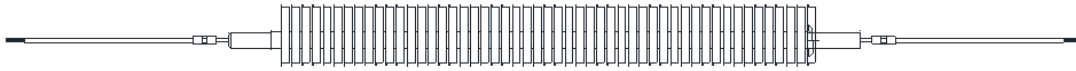

DISCRIPTION	PART NUMBERS					
	120V	208V	240V	277V	347V	600V
<b>*ELEMENT (100 WATTS/FT)</b>						
<b>28" HEATER</b>	1802-2001-047	1802-2001-048	1802-2001-049	NA	NA	NA
3'	1802-2001-053	1802-2001-054	1802-2001-055	1802-2001-056	NA	NA
4'	1802-2001-059	1802-2001-060	1802-2001-061	1802-2001-062	1802-2001-232	NA
5'	1802-2001-065	1802-2001-066	1802-2001-067	1802-2001-068	1802-2001-242	NA
6'	1802-2001-071	1802-2001-072	1802-2001-073	1802-2001-074	1802-2001-252	1802-2001-253
8'	NA	1802-2001-077	1802-2001-078	1802-2001-079	1802-2001-262	1802-2001-263
10'	NA	1802-2001-081	1802-2001-082	1802-2001-083	1802-2001-272	1802-2001-273
<b>*ELEMENT (125 WATTS/FT)</b>						
<b>28" HEATER</b>	1802-2001-085	1802-2001-086	1802-2001-048	1802-2001-049	NA	NA
3'	1802-2001-087	1802-2001-088	1802-2001-054	1802-2001-055	1802-2001-220	NA
4'	1802-2001-089	1802-2001-090	1802-2001-060	1802-2001-061	1802-2001-230	NA
5'	1802-2001-091	1802-2001-092	1802-2001-066	1802-2001-067	1802-2001-240	1802-2001-241
6'	1802-2001-093	1802-2001-094	1802-2001-072	1802-2001-073	1802-2001-250	1802-2001-251
8'	NA	1802-2001-095	1802-2001-077	1802-2001-078	1802-2001-260	1802-2001-261
10'	NA	1802-2001-096	1802-2001-081	1802-2001-082	1802-2001-270	1802-2001-271
<b>*ELEMENT (150 WATTS/FT)</b>						
<b>28" HEATER</b>	1802-2001-051	1802-2001-001	1802-2001-000	1802-2001-052	NA	NA
3'	1802-2001-057	1802-2001-007	1802-2001-006	1802-2001-058	1802-2001-218	NA
4'	1802-2001-063	1802-2001-013	1802-2001-012	1802-2001-064	1802-2001-228	NA
5'	1802-2001-069	1802-2001-019	1802-2001-018	1802-2001-070	1802-2001-238	1802-2001-239
6'	1802-2001-075	1802-2001-025	1802-2001-024	1802-2001-076	1802-2001-248	1802-2001-249
8'	NA	1802-2001-031	1802-2001-030	1802-2001-080	1802-2001-258	1802-2001-259
10'	NA	1802-2001-035	1802-2001-034	1802-2001-084	1802-2001-268	1802-2001-269
<b>*ELEMENT (188 WATTS/FT)</b>						
<b>24" HEATER</b>	1802-2001-038	1802-2001-039	1802-2001-040	1802-2001-041	1802-2001-200	NA
<b>28" HEATER</b>	1802-2001-005	1802-2001-002	1802-2001-001	1802-2001-000	NA	NA
3'	1802-2001-011	1802-2001-008	1802-2001-007	1802-2001-006	1802-2001-216	NA
4'	1802-2001-017	1802-2001-014	1802-2001-013	1802-2001-012	1802-2001-226	1802-2001-227
5'	1802-2001-023	1802-2001-020	1802-2001-019	1802-2001-018	1802-2001-236	1802-2001-237
6'	1802-2001-029	1802-2001-026	1802-2001-025	1802-2001-024	1802-2001-246	1802-2001-247
8'	NA	1802-2001-032	1802-2001-031	1802-2001-030	1802-2001-256	1802-2001-257
10'	NA	1802-2001-036	1802-2001-035	1802-2001-034	1802-2001-266	1802-2001-267
<b>LINEAR LIMIT</b>		<b>DISCONNECT SW.</b>	<b>THERMOSTAT</b>			
<b>28" HEATER</b>		410170001	<b>2-STAGE</b>	<b>SINGLE POLE</b>		
3'	4520-0007-007		5813-0023-000	410129002		
4'	4520-0007-008					
5'	4520-0007-009					
6'	4520-0007-010					
8'	4520-0007-011					
10'	4520-0007-012					
	4520-0007-013					

ICST SERIES



DISCRIPTION	PART NUMBERS					
	120V	208V	240V	277V	347V	600V
<b>*ELEMENT (125 WATTS/FT)</b>						
<b>28" HEATER</b>	1802-2001-085	1802-2001-086	1802-2001-048	1802-2001-049	NA	NA
3'	1802-2001-087	1802-2001-088	1802-2001-054	1802-2001-055	1802-2001-220	NA
4'	1802-2001-089	1802-2001-090	1802-2001-060	1802-2001-061	1802-2001-230	NA
5'	1802-2001-091	1802-2001-092	1802-2001-066	1802-2001-067	1802-2001-240	1802-2001-241
6'	1802-2001-093	1802-2001-094	1802-2001-072	1802-2001-073	1802-2001-250	1802-2001-251
8'	NA	1802-2001-095	1802-2001-077	1802-2001-078	1802-2001-260	1802-2001-261
10'	NA	1802-2001-096	1802-2001-081	1802-2001-082	1802-2001-270	1802-2001-271
<b>*ELEMENT (188 WATTS/FT)</b>						
<b>28" HEATER</b>	1802-2001-005	1802-2001-002	1802-2001-001	1802-2001-000	NA	NA
3'	1802-2001-011	1802-2001-008	1802-2001-007	1802-2001-006	1802-2001-216	NA
4'	1802-2001-017	1802-2001-014	1802-2001-013	1802-2001-012	1802-2001-226	1802-2001-227
5'	1802-2001-023	1802-2001-020	1802-2001-019	1802-2001-018	1802-2001-236	1802-2001-237
6'	1802-2001-029	1802-2001-026	1802-2001-025	1802-2001-024	1802-2001-246	1802-2001-247
8'	NA	1802-2001-032	1802-2001-031	1802-2001-030	1802-2001-256	1802-2001-257
10'	NA	1802-2001-036	1802-2001-035	1802-2001-034	1802-2001-266	1802-2001-267
<b>*ELEMENT (250 WATTS/FT)</b>						
<b>28" HEATER</b>	1802-2001-004	1802-2001-003	1802-2001-002	1802-2001-001	1802-2001-202	NA
3'	1802-2001-010	1802-2001-009	1802-2001-008	1802-2001-007	1802-2001-214	NA
4'	1802-2001-016	1802-2001-015	1802-2001-014	1802-2001-013	1802-2001-224	1802-2001-225
5'	1802-2001-022	1802-2001-021	1802-2001-020	1802-2001-019	1802-2001-234	1802-2001-235
6'	1802-2001-028	1802-2001-027	1802-2001-026	1802-2001-025	1802-2001-244	1802-2001-245
8'	NA	1802-2001-033	1802-2001-032	1802-2001-031	1802-2001-254	1802-2001-255
10'	NA	1802-2001-037	1802-2001-036	1802-2001-035	1802-2001-264	1802-2001-265



DISCRIPTION	PART NUMBERS					
	120V	208V	240V	277V	347V	600V
<b>LINEAR LIMIT</b>						
<b>28" HEATER</b>	4520-2018-001	4520-2018-001	4520-2018-001	4520-2018-001	4520-2018-001	4520-2018-001
3'	4520-2018-002	4520-2018-002	4520-2018-002	4520-2018-002	4520-2018-002	4520-2018-002
4'	4520-2018-003	4520-2018-003	4520-2018-003	4520-2018-003	4520-2018-003	4520-2018-003
5'	4520-2018-004	4520-2018-004	4520-2018-004	4520-2018-004	4520-2018-004	4520-2018-004
6'	4520-2018-005	4520-2018-005	4520-2018-005	4520-2018-005	4520-2018-005	4520-2018-005
8'	NA	4520-2018-006	4520-2018-006	4520-2018-006	4520-2018-006	4520-2018-006
10'	NA	4520-2018-007	4520-2018-007	4520-2018-007	4520-2018-007	4520-2018-007
<b>DISCONNECT SW.</b>	<b>THERMOSTAT</b>	<b>TRANSFORMER RELAY</b>		<b>J-BOX COVER</b>	<b>FRONT COVER</b>	
DS	<b>2-STAGE</b> 5813-0023-000 <b>SINGLE POLE</b> 5813-11014-000	<b>120V</b> 5018-11003-000 <b>208/240V</b> 5018-11003-001	<b>277V</b> 5018-11003-002 <b>347V</b> 5018-11003-003	<b>ALL MODELS</b> 1402-2250-000	1402-2251-000 1402-2251-001 1402-2251-002 1402-2251-003 1402-2251-004 1402-2251-005 1402-2251-006	28" 3' 4' 5' 6' 8' 10'

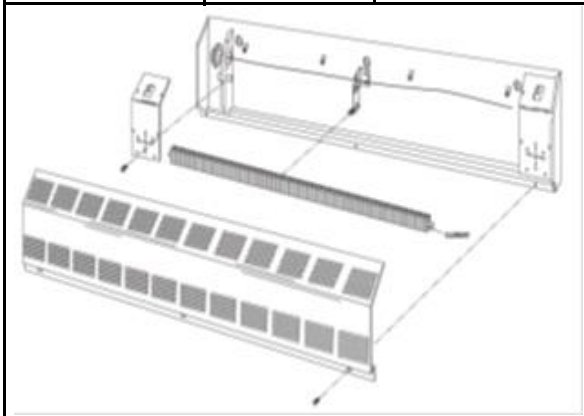

**CSL & CPL SERIES**

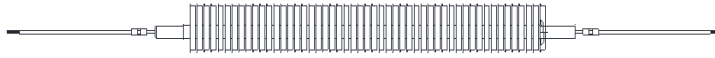







DISCRIPTION	PART NUMBERS					
	120V	208V	240V	277V	347V	600V
<b>*ELEMENT (125 WATTS/FT)</b>						
<b>28" HEATER</b>	1802-2001-085	1802-2001-086	1802-2001-048	1802-2001-049	NA	NA
3'	1802-2001-087	1802-2001-088	1802-2001-054	1802-2001-055	1802-2001-220	NA
4'	1802-2001-089	1802-2001-090	1802-2001-060	1802-2001-061	1802-2001-230	NA
5'	1802-2001-091	1802-2001-092	1802-2001-066	1802-2001-067	1802-2001-240	1802-2001-241
6'	1802-2001-093	1802-2001-094	1802-2001-072	1802-2001-073	1802-2001-250	1802-2001-251
8'	NA	1802-2001-095	1802-2001-077	1802-2001-078	1802-2001-260	1802-2001-261
10'	NA	1802-2001-096	1802-2001-081	1802-2001-082	1802-2001-270	1802-2001-271
<b>*ELEMENT (188 WATTS/FT)</b>						
<b>28" HEATER</b>	1802-2001-005	1802-2001-002	1802-2001-001	1802-2001-000	NA	NA
3'	1802-2001-011	1802-2001-008	1802-2001-007	1802-2001-006	1802-2001-216	NA
4'	1802-2001-017	1802-2001-014	1802-2001-013	1802-2001-012	1802-2001-226	1802-2001-227
5'	1802-2001-023	1802-2001-020	1802-2001-019	1802-2001-018	1802-2001-236	1802-2001-237
6'	1802-2001-029	1802-2001-026	1802-2001-025	1802-2001-024	1802-2001-246	1802-2001-247
8'	NA	1802-2001-032	1802-2001-031	1802-2001-030	1802-2001-256	1802-2001-257
10'	NA	1802-2001-036	1802-2001-035	1802-2001-034	1802-2001-266	1802-2001-267
<b>*ELEMENT (250 WATTS/FT)</b>						
<b>28" HEATER</b>	1802-2001-004	1802-2001-003	1802-2001-002	1802-2001-001	1802-2001-202	NA
3'	1802-2001-010	1802-2001-009	1802-2001-008	1802-2001-007	1802-2001-214	NA
4'	1802-2001-016	1802-2001-015	1802-2001-014	1802-2001-013	1802-2001-224	1802-2001-225
5'	1802-2001-022	1802-2001-021	1802-2001-020	1802-2001-019	1802-2001-234	1802-2001-235
6'	1802-2001-028	1802-2001-027	1802-2001-026	1802-2001-025	1802-2001-244	1802-2001-245
8'	NA	1802-2001-033	1802-2001-032	1802-2001-031	1802-2001-254	1802-2001-255
10'	NA	1802-2001-037	1802-2001-036	1802-2001-035	1802-2001-264	1802-2001-265

\* 1, 2 OR 3 ELEMENTS MAY BE REQUIRED. VOLTAGE AND WATTAGE ARE STAMPED ON END OF ELEMENTS. DIVIDE THE WATTAGE BY THE HEATER LENGTH (FEET) TO DETERMINE WATTS/FOOT OF ELEMENT. THEN USE THIS DATA TO DETERMINE PART NUMBER OF HEATING ELEMENT.



DISCRIPTION	PART NUMBERS					
	120V	208V	240V	277V	347V	600V
<b>LINEAR LIMIT</b>						
<b>28" HEATER</b>	4520-0007-007	4520-0007-007	4520-0007-007	4520-0007-007	4520-0007-007	4520-0007-007
3'	4520-0007-008	4520-0007-008	4520-0007-008	4520-0007-008	4520-0007-008	4520-0007-008
4'	4520-0007-009	4520-0007-009	4520-0007-009	4520-0007-009	4520-0007-009	4520-0007-009
5'	4520-0007-010	4520-0007-010	4520-0007-010	4520-0007-010	4520-0007-010	4520-0007-010
6'	4520-0007-011	4520-0007-011	4520-0007-011	4520-0007-011	4520-0007-011	4520-0007-011
8'	NA	4520-0007-012	4520-0007-012	4520-0007-012	4520-0007-012	4520-0007-012
10'	NA	4520-0007-013	4520-0007-013	4520-0007-013	4520-0007-013	4520-0007-013



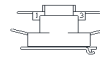



DISCONNECT SW.	THERMOSTAT	TRANSFORMER RELAY		24V TRANSFORMER
				
410170001	<b>2-STAGE</b> 5813-0023-000 <b>SINGLE POLE</b> 5813-0024-000	<b>120V</b> 5018-11003-000 <b>208/240V</b> 5018-11003-001	<b>277V</b> 5018-11003-002 <b>347V</b> 5018-11003-003	<b>208/240V PRIMARY</b> 490026001 <b>277V PRIMARY</b> 490026002

CIRCUIT BREAKER	POWER RELAY	
		
<b>2-POLE, 30A</b> 1226-7009-013 <b>2-POLE, 60A</b> 1226-7009-010 <b>3-POLE, 30A</b> 1226-7009-005 <b>3-POLE, 60A</b> 1226-7009-002	<b>24V</b> 410171001 <b>120V</b> 410171002 <b>208/240V</b> 410171003	<b>277V</b> 410171003

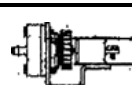

ASLC SERIES

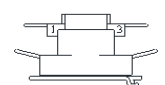

DISCRPTION	PART NUMBERS					
	120V	208V	240V	277V	347V	600V
<b>*ELEMENT (100 WATTS/FT)</b>						
<b>28" HEATER</b>	1802-2001-047	1802-2001-048	1802-2001-049	NA	NA	NA
3'	1802-2001-053	1802-2001-054	1802-2001-055	1802-2001-056	NA	NA
4'	1802-2001-059	1802-2001-060	1802-2001-061	1802-2001-062	1802-2001-232	NA
5'	1802-2001-065	1802-2001-066	1802-2001-067	1802-2001-068	1802-2001-242	NA
6'	1802-2001-071	1802-2001-072	1802-2001-073	1802-2001-074	1802-2001-252	1802-2001-253
8'	NA	1802-2001-077	1802-2001-078	1802-2001-079	1802-2001-262	1802-2001-263
10'	NA	1802-2001-081	1802-2001-082	1802-2001-083	1802-2001-272	1802-2001-273
<b>*ELEMENT (125 WATTS/FT)</b>						
<b>28" HEATER</b>	1802-2001-085	1802-2001-086	1802-2001-048	1802-2001-049	NA	NA
3'	1802-2001-087	1802-2001-088	1802-2001-054	1802-2001-055	1802-2001-220	NA
4'	1802-2001-089	1802-2001-090	1802-2001-060	1802-2001-061	1802-2001-230	NA
5'	1802-2001-091	1802-2001-092	1802-2001-066	1802-2001-067	1802-2001-240	1802-2001-241
6'	1802-2001-093	1802-2001-094	1802-2001-072	1802-2001-073	1802-2001-250	1802-2001-251
8'	NA	1802-2001-095	1802-2001-077	1802-2001-078	1802-2001-260	1802-2001-261
10'	NA	1802-2001-096	1802-2001-081	1802-2001-082	1802-2001-270	1802-2001-271
<b>*ELEMENT (150 WATTS/FT)</b>						
<b>28" HEATER</b>	1802-2001-051	1802-2001-001	1802-2001-000	1802-2001-052	NA	NA
3'	1802-2001-057	1802-2001-007	1802-2001-006	1802-2001-058	1802-2001-218	NA
4'	1802-2001-063	1802-2001-013	1802-2001-012	1802-2001-064	1802-2001-228	NA
5'	1802-2001-069	1802-2001-019	1802-2001-018	1802-2001-070	1802-2001-238	1802-2001-239
6'	1802-2001-075	1802-2001-025	1802-2001-024	1802-2001-076	1802-2001-248	1802-2001-249
8'	NA	1802-2001-031	1802-2001-030	1802-2001-080	1802-2001-258	1802-2001-259
10'	NA	1802-2001-035	1802-2001-034	1802-2001-084	1802-2001-268	1802-2001-269
<b>*ELEMENT (188 WATTS/FT)</b>						
<b>24" HEATER</b>	1802-2001-038	1802-2001-039	1802-2001-040	1802-2001-041	1802-2001-200	NA
<b>28"</b>	1802-2001-005	1802-2001-002	1802-2001-001	1802-2001-000	NA	NA
3'	1802-2001-011	1802-2001-008	1802-2001-007	1802-2001-006	1802-2001-216	NA
4'	1802-2001-017	1802-2001-014	1802-2001-013	1802-2001-012	1802-2001-226	1802-2001-227
5'	1802-2001-023	1802-2001-020	1802-2001-019	1802-2001-018	1802-2001-236	1802-2001-237
6'	1802-2001-029	1802-2001-026	1802-2001-025	1802-2001-024	1802-2001-246	1802-2001-247
8'	NA	1802-2001-032	1802-2001-031	1802-2001-030	1802-2001-256	1802-2001-257
10'	NA	1802-2001-036	1802-2001-035	1802-2001-034	1802-2001-266	1802-2001-267
<b>*ELEMENT (250 WATTS/FT)</b>						
<b>28" HEATER</b>	1802-2001-004	1802-2001-003	1802-2001-002	1802-2001-001	1802-2001-202	NA
3'	1802-2001-010	1802-2001-009	1802-2001-008	1802-2001-007	1802-2001-214	NA
4'	1802-2001-016	1802-2001-015	1802-2001-014	1802-2001-013	1802-2001-224	1802-2001-225
5'	1802-2001-022	1802-2001-021	1802-2001-020	1802-2001-019	1802-2001-234	1802-2001-235
6'	1802-2001-028	1802-2001-027	1802-2001-026	1802-2001-025	1802-2001-244	1802-2001-245
8'	NA	1802-2001-033	1802-2001-032	1802-2001-031	1802-2001-254	1802-2001-255
10'	NA	1802-2001-037	1802-2001-036	1802-2001-035	1802-2001-264	1802-2001-265
   						
<b>LINEAR LIMIT</b>		<b>DISCONNECT SW.</b>	<b>THERMOSTAT</b>	<b>P.E. SWITCH</b>		
<b>28" HEATER</b>	4520-0007-007	410170001	<b>2-STAGE</b>	410172001		
3'	4520-0007-008		5813-0023-000			
4'	4520-0007-009		<b>SINGLE POLE</b>			
5'	4520-0007-010		5813-0024-000			
6'	4520-0007-011					
8'	4520-0007-012					
10'	4520-0007-013					
  						
<b>TRANSFORMER</b>			<b>POWER RELAY</b>			
<b>120V</b>	<b>277V</b>	<b>24V</b>	<b>208/240V/277V</b>			
5018-11003-000	5018-11003-002	410171001	410171003			
<b>208/240V</b>	<b>347V</b>	<b>120V</b>				
5018-11003-001	5018-11003-003	410171002				

THX FLOOR DROP-IN CONVECTOR							
ELEMENTS							
2 FOOT 188W/FT		2 FOOT 250W/FT		3 FOOT 188W/FT		3 FOOT 250W/FT	
208V	1802-2001-039	208V	1802-2001-198	208V	1802-2001-008	208V	1802-2001-009
240V	1802-2001-040	240V	1802-2001-099	240V	1802-2001-007	240V	1802-2001-008
277V	1802-2001-041	277V	1802-2001-200	277V	1802-2001-006	277V	1802-2001-007
4 FOOT 188W/FT		4 FOOT 250W/FT		5 FOOT 188W/FT		5 FOOT 250W/FT	
208V	1802-2001-014	208V	1802-2001-015	208V	1802-2001-020	208V	1802-2001-021
240V	1802-2001-013	240V	1802-2001-014	240V	1802-2001-019	240V	1802-2001-020
277V	1802-2001-012	277V	1802-2001-013	277V	1802-2001-018	277V	1802-2001-019

GRILLE							
2 FOOT FLUSH		2 FOOT SURFACE		3 FOOT FLUSH		3 FOOT SURFACE	
ALUMINUM	2501-11033-001	ALUMINUM	2501-11033-005	ALUMINUM	2501-11033-002	ALUMINUM	2501-11033-006
BLACK	2501-11033-101	BLACK	2501-11033-105	BLACK	2501-11033-102	BLACK	2501-11033-106
WHITE	2501-11033-201	WHITE	2501-11033-205	WHITE	2501-11033-202	WHITE	2501-11033-206
4 FOOT FLUSH		4 FOOT SURFACE		5 FOOT FLUSH		5 FOOT SURFACE	
ALUMINUM	2501-11033-003	ALUMINUM	2501-11033-007	ALUMINUM	2501-11033-004	ALUMINUM	2501-11033-008
BLACK	2501-11033-103	BLACK	2501-11033-107	BLACK	2501-11033-104	BLACK	2501-11033-108
WHITE	2501-11033-203	WHITE	2501-11033-207	WHITE	2501-11033-204	WHITE	2501-11033-208

TRANSFORMER	
277V	208/240V
5018-11003-002	5018-11003-001

TIME DELAY RELAY		
24V CONTROL	120V CONTROL	208-277V CONTROL
410171001	410171002	410171003

LINEAR LIMIT			
2 FOOT	3 FOOT	4 FOOT	5 FOOT
4520-0007-007	4520-0007-008	4520-0007-009	4520-0007-010

MANUAL RESET LIMIT			
2 FOOT	3 FOOT	4 FOOT	5 FOOT
4520-2017-000	4520-2017-000	4520-2017-001	4520-2017-001

POWER ON/OFF SW
ALL MODELS 410170001
J-BOX COVER
ALL MODELS 1215-11125-000



**XRM SERIES**

**ELEMENT**

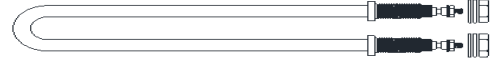
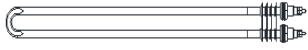

<b>1802-7076-002</b> M2081B M6083B	<b>1802-7076-007</b> M4581B M13583B	<b>1802-2110-007</b> M6043A	<b>HE45208</b> M4581 M13583	<b>HE20208</b> M6083
<b>1802-7076-003</b> M2021B M6023B	<b>1802-7076-008</b> M4521B M13523B	<b>1802-2110-009</b> M4581A M13583A	<b>HE45240</b> M4521 M13523	<b>HE20240</b> M6023
<b>1802-7076-004</b> M6071B	<b>1802-7076-009</b> M13571B	<b>1802-2110-011</b> M4521A M13523A	<b>HE45480</b> M4541 M13543	<b>HE20480</b> M6043
<b>1802-7076-005</b> M2041B M6043B	<b>1802-7076-010</b> M4541B M13543B	<b>1802-2110-015</b> M4541A M13543A	<b>HE45600</b> M13563	<b>HE20600</b> M6063
<b>1802-7076-006</b> M2061B M6063B	<b>1802-7076-011</b> M4561B M13563B	<b>1802-2110-016</b> M13563A		

**NOTES**

6KW AND 13.5KW UNITS TAKE THREE ELEMENTS



2.0 KW



6.0 KW Fixed



4.5 KW Fixed

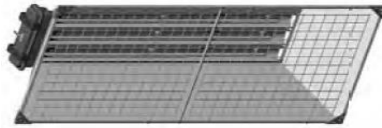







13.5 KW Fixed w/Grille

**REFLECTOR**

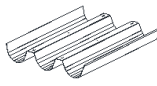





<b>891755004</b> M6023B M6043B	<b>891755002</b> M13523B M13543B M4521B M4541B
--------------------------------------	--

**VRP/VRS SERIES RADIANT HEATERS**

ELEMENTS					REFLECTOR			
								
PART NUMBER	TYPE	VOLTS	WATTS	USED WITH FIXTURE	5007-2003-000	5007-2003-001	5007-2003-002	
2MS08208 2MS08240 2MS08277 2MS08347 2MS08480 2MS08600	METAL SHEATH	208 240 277 347 480 600	850	RP22 RS2 RP32 RS32	RP223ASA RS223ASA	RP233ASA RS233ASA	RP243ASA RS243ASA	
2QT10208 2QT10240 2QT10277 NA	QUARTS TUBE	208 240 277 NA	1000		5007-2010-000 RP2235A RS2235A	5007-2010-001 RP2335A RS2335A	5007-2010-002 RP2435A RS2435A	
2QL16208 2QL16240 2QL16277 2QL16347 2QL16480 2QL16600	QUARTS LAMP	208 240 277 347 480 600	1600		5007-2011-000 RP226ASA RS226ASA	5007-2011-001 RP236ASA RS236ASA	5007-2011-002 RP246ASA RS246ASA	
3MS15208 3MS15240 3MS15277 3MS15347 3MS15480 3MS15600	METAL SHEATH	208 240 277 347 480 600	1500		RP23 RS23 RP33 RS33	5007-2009-000 RP2265A RP2295A RS2265A RS2295A	5007-2009-001 RP2365A RP2395A RS2365A RS2395A	5007-2009-002 RP2465A RP2495A RS2465A RS2495A
3QT15208 3QT15240 3QT15277 3QT15347 3QT15480 3QT15600	QUARTS TUBE	208 240 277 347 480 600	1500					
3QL25208 3QL25240 3QL25277 3QL25347 3QL25480 3QL25600	QUARTS LAMP	208 240 277 347 480 600	2500			5007-2008-000 RP323ASA RS323ASA	5007-2008-001 RP333ASA RS333ASA	5007-2008-002 RP343ASA RS343ASA
4MS20208 4MS20240 4MS20277 4MS20347 4MS20480 4MS20600	METAL SHEATH	208 240 277 347 480 600	2000	5007-2017-000 RP3235A RS3235A		5007-2017-001 RP3335A RS3335A	5007-2017-002 RP3435A RS3435A	
4QT20208 4QT20240 4QT20277 4QT20347 4QT20480 4QT20600	QUARTS TUBE	208 240 277 347 480 600	2000	5007-2018-000 RP326ASA RS326ASA		5007-2018-001 RP336ASA RS336ASA	5007-2018-002 RP346ASA RS346ASA	
4QL36347 4QL36480 4QL36600	QUARTS LAMP	347 480 600	3650	5007-2016-000 RP3265A RP3295A RS3265A RS3295A		5007-2016-001 RP3365A RP3395A RS3365A RS3395A	5007-2016-002 RP3465A RP3495A RS3465A RS3495A	
					<b>ELEMENT TERM BUSH*</b>		<b>TERMINAL BLOCK*</b>	
								
					ALL MODELS 1213-0070-000	ALL MODELS 1224-0049-000		
					<b>NOTES</b> * FOUR REQUIRED ON 2 ELEMENT AND SIX FOR 3 ELEMENT FIXTURES			
					 			





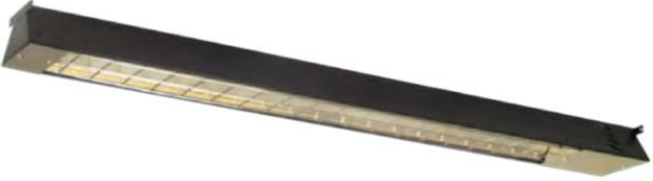

**JRK SERIES**

ELEMENT		REFLECTOR	
			
<b>1802-2113-501</b> RK41512A	<b>1802-2113-515</b> RK53020A	<b>5007-2013-000</b> RK41512A RK42020A RK42024A RK42027A RK42034A RK42048A RK42060A	<b>5007-2013-001</b> RK53020A RK53024A RK53027A RK53034A RK53048A RK53060A
<b>1802-2113-509</b> RK42020A	<b>1802-2113-516</b> RK53024A		
<b>1802-2113-510</b> RK42024A	<b>1802-2113-517</b> RK53027A		
<b>1802-2113-511</b> RK42027A	<b>1802-2113-518</b> RK53034A		
<b>1802-2113-512</b> RK42034A	<b>1802-2113-519</b> RK53048A		
<b>1802-2113-513</b> RK42048A	<b>1802-2113-520</b> RK53060A		
<b>1802-2113-514</b> RK42060A			
<b>CHAIN 2 REQ.</b>	<b>"S" HOOK 4 REQ.</b>	<b>TERMINAL COVER LONG</b>	<b>TERMINAL COVER SHORT</b>
			
<b>1404-2000-001</b> ALL MODELS	<b>2706-2000-000</b> ALL MODELS	<b>1402-2275-000</b> ALL MODELS	<b>1402-2275-001</b> ALL MODELS
			

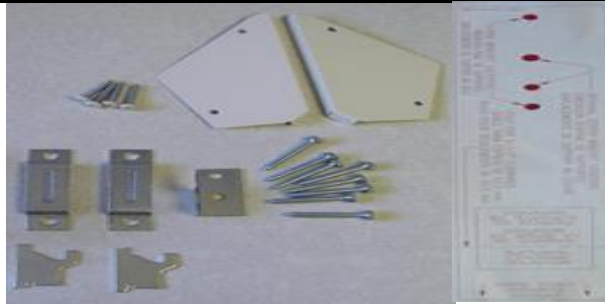
## RCC COVE HEATERS (C & D SERIES)

### PARTS KIT\*

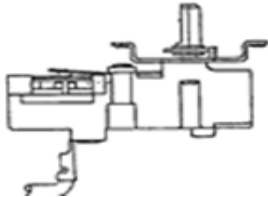

<b>WHITE</b> 3303-2032-000	<b>DOVE GRAY</b> 3303-2032-001	<b>DESERT TAN</b> 3303-2032-002
<b>CENTER SUP BRACKET**</b>	<b>THERMOSTAT</b>	<b>THERMOSTAT KNOB</b>
		
<b>ALL MODELS</b> 1215-2309-000	<b>ALL MODELS</b> 410129001	<b>ALL MODELS</b> 3301-2020-006













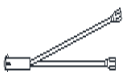

**NOTES**

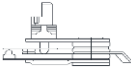

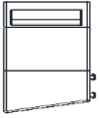

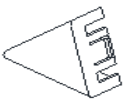





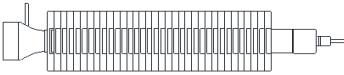
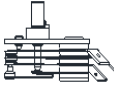

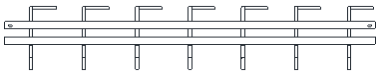

**REPLACE HEATER IF FRONT COVER OR ELEMENT IS NEEDED**

**\* PARTS KIT INCLUDES MOUNTING BRACKETS, MOUNTING TEMPLATE, AND END CAPS**



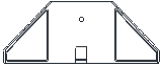



**\*\* 1500 & 1800 WATT MODELS TAKE TWO CENTER SUPPORT BRACKETS**

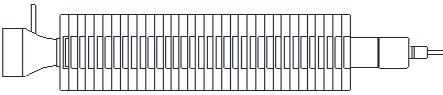

FBE SERIES					
ELEMENT		SWITCH			LIGHT
					
1802-2087-000 FBE15002C FBE15002CA		<del>5216-2007-000</del> FBE1000A FBE1200 FBE1250A	5216-2010-000 FBE15002 FBE15002A	5216-2027-000 FBE15002B FBE15002C FBE15002CA	3510-2008-001 FBE1504C
LIMIT	THERMOSTAT	KNOB		FACE PLATE	
					
4520-2011-004 FBE1500C FBE15002A FBE15002B FBE15002C FBE15002CA	5813-2058-001 FBE1200 FBE1200C FBE1500C FBE15002B FBE15002C FBE15002CA FBE1504C	3301-2017-000 FBE1000A FBE1250A FBE15002 FBE15002A	3301-2011-003 FBE1200 FBE1200C FBE1500C FBE15002B FBE15002C FBE15002CA FBE1504C	1402-2122-139 FBE1000A	1402-2122-136 FBE15002
				1402-2122-141 FBE1200	1402-2122-138 FBE15002A
				1402-2122-125 FBE1200C	1402-2122-142 FBE15002B
				1402-2122-140 FBE1250A	1402-2122-626 FBE15002CA
END CAP RIGHT	END CAP LEFT	LEG RIGHT	LEG LEFT	CORD	CONTROL COVER
					
1800-2047-001 FBE1200C FBE1500C FBE15002C FBE15002CA FBE1504C	1800-2048-001 FBE1200C FBE1500C FBE15002C FBE15002CA FBE1504C	3507-2004-001 FBE1200C FBE1500C FBE15002C FBE15002CA FBE1504C	3507-2005-001 FBE1200C FBE1500C FBE15002C FBE15002CA FBE1504C	1420-2027-001 FBE15002C 1420-11013-000 FBE15002CA	1402-2243-001 FBE15002B FBE15002C FBE15002CA
					

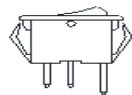
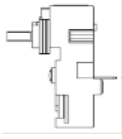
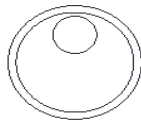

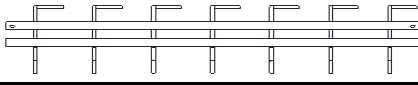
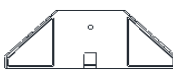



LFP SERIES (OBSOLETE)					
ELEMENT		THERMOSTAT		LIMIT	
					
1802-2067-023 LFP6152D LFP6152E LFP6152EA		1802-2067-001 LFP675D		5813-2019-000 LFP6152 LFP6152D LFP6152E LFP6152EA	
5813-2001-000 LFP675 LFP675D		410163004 LFP6152 LFP6152D LFP6152E LFP6152EA		4520-2010-001 LFP675 LFP675D	
GRILLE	LIGHT	DIODE BRIDGE	FRONT COVER	CORD	
					
2501-2012-015 LFP6152 LFP6152D LFP6152E LFP6152EA	2501-2012-013 LFP675 LFP675D	3510-2006-000 LFP6152 LFP6152D LFP6152E LFP6152EA	DBKIT LFP6152 LFP6152D LFP6152E LFP6152EA	1402-2066-609 LFP6152EA	
1420-11013-000 LFP6152D LFP6152E LFP6152EA		KNOB	LEG	SWITCH	END CAP
					
3301-2011-001 LFP6152 LFP6152D LFP6152E LFP6152EA LFP675 LFP675D		3507-2003-000 LFP6152 LFP6152D LFP6152E LFP6152EA LFP675 LFP675D	<del>5216-2007-000</del> LFP6152 LFP6152D LFP6152E LFP6152EA LFP675 LFP675D	1800-2027-000 LFP6152 LFP6152D LFP6152E LFP6152EA LFP675 LFP675D	

## FHP SERIES







ELEMENT		LIMIT		SWITCH	
					
<b>1802-2067-001</b> FHP0750KCT FHP0750KCTA FHP0750T FHP0750TA	<b>1802-2067-023</b> FHP1500KCT FHP1500KCTA FHP1500T FHP1500TA	<b>4520-0011-000</b> FHP0750KCT FHP0750KCTA FHP0750T FHP0750TA	<b>410163004</b> FHP1500KCT FHP1500KCTA FHP1500T FHP1500TA	<b>5216-11020-000</b> FHP0750KCT FHP0750KCTA FHP0750T FHP0750TA FHP1500KCT FHP1500KCTA FHP1500T FHP1500TA	
THERMOSTAT		KNOB	FRONT COVER		END CAP
					
<b>5813-11012-000</b> FHP0750KCT FHP0750KCTA FHP0750T FHP0750TA FHP1500KCT FHP1500KCTA FHP1500T FHP1500TA	<b>3301-2011-005</b> FHP0750KCT FHP0750KCTA FHP0750T FHP0750TA FHP1500KCT FHP1500KCTA FHP1500T FHP1500TA	<b>1402-2066-607</b> FHP0750KCT FHP0750KCTA FHP0750T FHP0750TA	<b>1402-2066-609</b> FHP1500KCT FHP1500KCTA FHP1500T FHP1500TA	<b>1800-2027-000</b> FHP0750KCT FHP0750KCTA FHP0750T FHP0750TA FHP1500KCT FHP1500KCTA FHP1500T FHP1500TA	
GRILLE		LEGS (2 REQ)	CORD		
					
<b>2501-2012-013</b> FHP0750KCT FHP0750KCTA FHP0750T FHP0750TA	<b>2501-2012-015</b> FHP1500KCT FHP1500KCTA FHP1500T FHP1500TA	<b>3507-2003-000</b> FHP0750KCT FHP0750KCTA FHP0750T FHP0750TA FHP1500KCT FHP1500KCTA FHP1500T FHP1500TA	<b>1420-11013-000</b> FHP0750KCT FHP0750KCTA FHP0750T FHP0750TA FHP1500KCT FHP1500KCTA FHP1500T FHP1500TA		

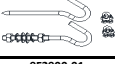

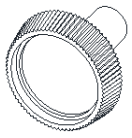
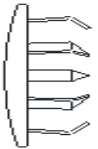
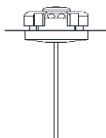
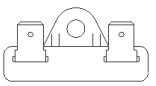
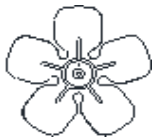



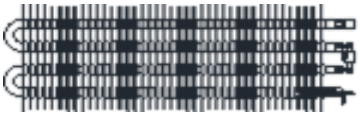



DOE INDUSTRIAL/COMMERCIAL CEILING FANS



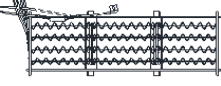





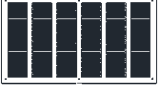

			ASSEMBLY HAS SHACKLE AND RUBBER ROLLER					
MODEL	BLADES SET OF 3	MOTOR	DOWN ROD	SHACKLE	UPPER CANOPY	LOWER CANOPY	RUBBER ROLLER	SPEED CONTROL
56001HP	985600-1HP	9M5600-1HP	9D24BW	9F2900-03A	9F2900-07A	9F2900-08A	9F2900-04A	12003
56001HP-BRN	985600-1HPB		9D24BB	9F2900-03A	9FP029	9FP030	9F2900-04A	12003
56001HPDOE-K	985600-1HP	9M5600-1HP	9D24BW	9F2900-03A	9F2900-07A	9F2900-08A	9F2900-04A	12003
56001HPDOEBRN-K	985600-1HPB		9D24BB	9F2900-03A	9FP029	9FP030	9F2900-04A	12003
56001LCCDOE	985600-1LCC	9M5600-1LCC	9D24BW	9F2900-03A	9F2900-07A	9F2900-08A	9F2900-04A	CTL12004RSPDDOE
56001LCCDOE-K	985600-1LCC	9M5600-1LCC	9D24BW	9F2900-03A	9F2900-07A	9F2900-08A	9F2900-04A	CTL12004RSPDDOE
56201CLSDOE	9856201CLS-1	9M56201CLS-1	9D24BW	9F2900-03A	9F2900-07A	9F2900-08A	9F2900-04A	CTL12004RSPDDOE
56201CLSDOE-K	9856201CLS-1	9M56201CLS-1	9D24BW	9F2900-03A	9F2900-07A	9F2900-08A	9F2900-04A	CTL12004RSPDDOE
56007HPDOE	985600-7HP	9M5600-7HP	9D24BW	9F2900-03A	9F2900-07A	9F2900-08A	9F2900-04A	27708
56007HPDOE-K	985600-7HP	9M5600-7HP	9D24BW	9F2900-03A	9F2900-07A	9F2900-08A	9F2900-04A	27708
60001HPDOE	986000-1HP	9M6000-1HP	9D24BW	9F2900-03A	9F2900-07A	9F2900-08A	9F2900-04A	12003
60001HPDOE-BRN	986000-1HPB		9D24BB	9F2900-03A	9FP029	9FP030	9F2900-04A	12003
60001HPDOE-K	986000-1HP	9M6000-1HP	9D24BW	9F2900-03A	9F2900-07A	9F2900-08A	9F2900-04A	12003
60001HPDOEBRN-K	986000-1HPB		9D24BB	9F2900-03A	9FP029	9FP030	9F2900-04A	12003
36201DOE	983620-1C	9M3620-1C	9D24BB	9F2900-03A	9F2900-07A	9F2900-08A	9F2900-04A	CTL12004RSPDDOE
36201DOE-K	983620-1C	9M3620-1C	9D24BB	9F2900-03A	9F2900-07A	9F2900-08A	9F2900-04A	CTL12004RSPDDOE
48201DOE	9848201-1C	9M48201-1C	9D24BB	9F2900-03A	9F2900-07A	9F2900-08A	9F2900-04A	CTL12004RSPDDOE
48201DOE-K	9848201-1C	9M48201-1C	9D24BB	9F2900-03A	9F2900-07A	9F2900-08A	9F2900-04A	CTL12004RSPDDOE

J HOOK KIT	MODELS ENDING IN K COME WITH SPEED CONTROL		
	VARIABLE SP. CONTROL	VOLTS	AMPS
	12003	120	3
	12006	120	6
	12008	120	8
9F2900-01	12012	120	12
ALL MODELS	27708	277	8
	NOISELESS SP. CONTROL		
	12001N	120	1
	12005N	120	5
	REVERSING SP. CONTROL		
	CTL12004RSPDDOE	120	4

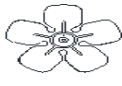
MCSSAR SERIES (OBSOLETE)					
KNOB	PLUG BUTTON	MANUAL RESET	THERMAL FUSE	FAN BLADE	THERMOSTAT
					
<b>3301-11013-000</b> ALL MODELS	<b>4506-2012-009</b> ALL MODELS	<b>4520-11019-000</b> ALL MODELS	<b>4520-2030-000</b> ALL MODELS	<b>490030103</b> ALL MODELS	<b>5813-2027-001</b> ALL MODELS
<b>FAN DELAY</b>			<b>LIGHT</b>		
					
<b>1414-2039-000</b> MCARWH1802 MCARWH1802AL MCARWH1802BZ MCARWH1802W	<b>410074000</b> MCARWH4804 MCARWH4804AL MCARWH4804BZ MCARWH4804W MCARWH4807 MCARWH4807AL MCARWH4807AL	MCARWH4807BZ MCARWH4807W MCARWH4808 MCARWH4808AL MCARWH4808BZ MCARWH4808W	<b>3510-2017-000</b> MCARWH1802 MCARWH1802AL MCARWH1802BZ MCARWH1802W	<b>3510-2017-001</b> MCARWH4804 MCARWH4804AL MCARWH4804BZ MCARWH4804W MCARWH4807 MCARWH4807AL MCARWH4807BZ MCARWH4807W MCARWH4808 MCARWH4808AL MCARWH4808BZ MCARWH4808W	
<b>MOTOR</b>			<b>ELEMENT</b>		<b>DISCONNECT SWITCH</b>
					
<b>3900-2010-003</b> MCARWH1802 MCARWH1802AL MCARWH1802BZ MCARWH1802W	<b>3900-2010-000</b> MCARWH4804 MCARWH4804AL MCARWH4804BZ MCARWH4804W MCARWH4808 MCARWH4808AL MCARWH4808BZ MCARWH4808W	<b>3900-2010-001</b> MCARWH4807 MCARWH4807AL MCARWH4807BZ MCARWH4807W	<b>302012828</b> MCARWH1802 MCARWH1802AL MCARWH1802BZ MCARWH1802W <b>302012811</b> MCARWH4807 MCARWH4807AL MCARWH4807BZ MCARWH4807W	<b>302012810</b> MCARWH4804 MCARWH4804AL MCARWH4804BZ MCARWH4804W <b>302012807</b> MCARWH4808 MCARWH4808AL MCARWH4808BZ MCARWH4808W	<b>410170001</b> ALL MODELS 

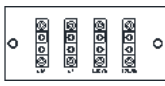
QFG-SERIES (OBSOLETE)													
KNOB		GRILLE		BLOWER ASM				CLIP N FIT BOARD		THERMOSTAT			
													
<b>3301-2040-001</b> G1512T2M G2024T2M G1512T2MA G2024T2MA G2224T2MA G1512T2MB G2024T2MB G2224T2MB G1512T2MC G2024T2MC G2224T2MC		<b>2501-2046-000</b> ALL MODELS		<b>1225-2002-000</b> G1012IF G1512IF G1512M G1512T2M G1512IFMA G1512MA G1512T2MA G1512IFMB G1512MB G1512T2MB G1512IFMC G1512T2MC		<b>1225-2002-001</b> G1024IF G1524IF G2024IF G2024M G2028IF G2224IF G2224M G2024IFMA G2024MA G2024T2MA G2028IFA G2224IFMA G2224MA		<b>1225-2002-001</b> G2224T2MA G2024IFMB G2224T2MB G2024MB G2024T2MB G2028IFB G2224T2MC G2024FMC G2024T2MC		<b>1249-2005-000</b> G1512M G1512T2M G2024M G2024T2M G2224M G1512MA G1512T2MA G2024IFMA G2024MA G2024T2MA G2224IFMA G2224MA G2224T2MA G1512IFMB G1512MB G1512T2MB G2024IFMB G2024MB G2024T2MB G2228IFB G1512IFMC G1512T2MC G2024IFMC G2024T2MC G2224IFC G2224T2MC G2228IFC		<b>410130001</b> G1512T2M G1512T2MA G1512T2MB G2024T2M G2024T2MA G2224T2MA G2024T2MB G2224T2MB G1512T2MC G2024T2MC G2224T2MC	
<b>ELEMENT</b> 				<b>HI LIMIT</b> 				<b>LIGHT</b> 					
<b>1802-2124-005</b> G1024IF G2024IF		<b>1802-2124-000</b> G1512IF G1512IFMA		<b>4520-11012-000</b> G1512IFMC G1512T2MC		<b>4520-11012-001</b> G2024IFMC G2024T2MC G2224IFC G2224T2MC G2228IFC		<b>4520-2059-000</b> G1012IF G1512IF G1512M G1512T2M G1512IFMA G1512MA G1512T2MA G1512IFMB G1512MB G1512T2MB G1024IF G1524IF G2024IF G2024M G2024T2M G2228IFB G2224IFMB G2224T2MB		<b>3510-2017-000</b> G1012IF G1512IF G1512M G1512T2M G1512IFMA G1512MA G1512T2MA G1512IFMB G1512MB G1512T2MB G1512IFMC G1512T2MC		<b>3510-2017-001</b> G1024IF G1524IF G2024IF G2024M G2024T2M G2028IF G2224IF G2224M G2024IFMA G2024MA G2024T2MA G2224IFC G2224T2MC G2228IFC	
<b>1802-2125-000</b> G1512IFMB G1512MB G1512T2MB G1512IFMC G1512T2MC		<b>1802-2125-002</b> G2024IFMB G2024MB G2024T2MB G2024IFMC G2024T2MC				<b>4520-2059-000</b> G1512IFMA G2024MA G2024T2MA G2028IFA G2224IFMA G2224MA G2224T2MA G2024IFMB G2024MB G2024T2MB G2024M G2028IFB G2224IFMB G2224T2MB		<b>3510-2017-000</b> G1512IFMA G1512MA G1512T2MA G1512IFMB G1512MB G1512T2MB G1512IFMC G1512T2MC		<b>3510-2017-001</b> G2024IFMB G2024MB G2024T2MB G2224IFMB G2228IFB G2024IFMC G2024T2MC G2224IFC G2224T2MC G2228IFC			
<b>1802-2124-001</b> G2028IFB		<b>1802-2125-001</b> G2224IFMB G2224IFC G2224T2MC				<b>4520-2059-000</b> G2024M G2024T2M G2224IFMB G2224T2MB		<b>3510-2017-000</b> G2024MA G2024T2MA G2224IFC G2224T2MC G2228IFC		<b>3510-2017-001</b> G2224IFMA G2224MA G2224T2MA			
<b>MODELS NOT LISTED ELEMENTS ARE OBSOLETE</b>													



**MFQ-SERIES (OBSOLETE)**

MFQ-SERIES (OBSOLETE)						
GRILLE	ELEMENTS (2 REQ)			MOTOR (2 REQ)		
						
<b>2501-2027-000</b> ALL MODELS	<b>302012819</b> Q6003	<b>302012821</b> Q8003	<b>302012809</b> Q6004 Q8007	<b>3900-2010-000</b> Q6003 Q6004 Q60048 Q6006 Q6008 Q8003 Q8004 Q80048 Q8006 Q8008	<b>3900-2010-001</b> Q6007 Q8007	
	<b>302012820</b> Q6006 Q8006	<b>302012826</b> Q80048 <b>302012808</b> Q6008 Q8004	<b>302012806</b> Q6007 <b>302012807</b> Q8008			
	<b>302012825</b> Q60048					
THERMOSTAT	FAN BLADE (2 REQ)	DISCONNECT SW.	TERMINAL BOARD			
						
<b>410168002 (2REQ.)</b> Q6003 Q60048 Q6006 Q8003 Q80048 Q8006	<b>5813-0023-000</b> Q6004 Q6007 Q6008 Q8004 Q8007 Q8008	<b>490030103</b> ALL MODELS	<b>5216-2025-000</b> ALL MODELS	<b>5823-2002-000</b> ALL MODELS		
TRANSFORMER		FAN DELAY (2 REQ)	MANUAL LIMIT (2 REQ)			
						
<b>490015017</b> Q6003 Q8003	<b>490015022</b> Q60048 Q80048	<b>490015013</b> Q6006 Q8006	<b>410074000</b> ALL MODELS	<b>4520-2027-000</b> ALL MODELS		





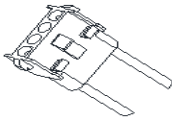
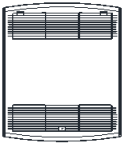
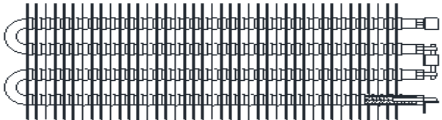







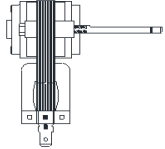



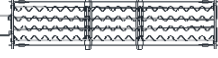

**ECP SERIES (OBSOLETE)**



PLUG ASSY FEMALE	GRILLE	ELEMENT		LIMIT
				
<p><b>1016-0114-000</b> ALL MODELS</p>	<p><b>2501-2082-000</b> ALL MODELS</p>	<p><b>302012808</b> ECP1024</p>	<p><b>302012803</b> ECP1524</p>	<p><b>4520-2025-001</b> ALL MODELS</p>
				



**MFA SERIES (OBS)**

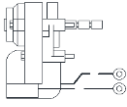
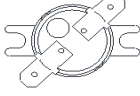

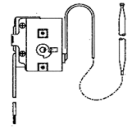
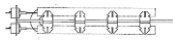
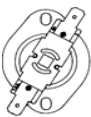

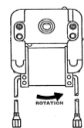

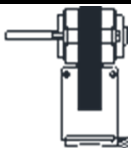
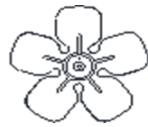
ELEMENTS					LIMIT			
								
<b>1802-2021-000</b>		<b>1802-2021-003</b>		<b>1802-2021-004</b>		<b>4520-2023-000</b>		
A1000IF	A1500IF	A1504IF	A1004IF	A2004T2B	A1000IF	A1500IFBNW	A2004IFB	
A1000IFA	A1500IFA	A1504IFA	A1004IFA	A2004T2BNW	A1000IFB	A1500T	A2004IFBNW	
A1000IFB	A1500IFB	A1504IFB	A1004IFB	A2404IF	A1000IFBNW	A1500T2B	A2004T	
A1000IFBNW	A1500IFBNW	A1504IFBNW	A1004IFBNW	A2404IFA	A1000T	A1500T2BNW	A2004T2B	
A1000T	A1500T	A1504T	A2004IF	A2404IFB	A1000T2B	A1504IF	A2004T2BNW	
A1000TA	A1500TA	A1504TA	A2004IFA	A2404IFBNW	A1000T2BNW	A1504IFB	A2404IF	
A1000T2	A1500T2	A1504T2	A2004IFB	A2404T	A1004IF	A1504IFBNW	A2404IFB	
A1000T2B	A1500T2B	A1504T2B	A2004IFBNW	A2404TA	A1004IFB	A1504T	A2404IFBNW	
A1000T2BNW	A1500T2BNW	A1504T2BNW	A2004T	A2404T2	A1004IFBNW	A1504T2B	A2404T	
			A2004TA	A2404T2B	A1500IF	A1504T2BNW	A2404T2B	
			A2004T2	A2404T2BNW	A1500IFB	A2004IF	A2404T2BNW	
<b>MOTOR</b>					<b>THERMOSTAT</b>			
								
<b>3900-2017-000</b>		<b>3900-2017-001</b>			<b>5813-2001-000</b>		<b>5813-2015-000</b>	
A0500IFA	A1000T2	A0504IFA	A1504IF	A2004TA	A0504TA	A0504T2	A1500T2BNW	
A0500IFB	A1000T2B	A0504IFB	A1504IFA	A2004T2	A1000T	A0504T2B	A1504T2B	
A0500IFBNW	A1000T2BNW	A0504IFBNW	A1504IFB	A2004T2B	A1000TA	A0504T2BNW	A1504T2BNW	
A0750IFA	A1500IF	A0504TA	A1504IFBNW	A2004T2BNW	A1500T	A1000T2	A2004T2	
A0750IFB	A1500IFA	A0504T2	A1504T	A2404IF	A1500TA	A1000T2B	A2004T2B	
A0750IFBNW	A1500IFB	A0504T2B	A1504TA	A2404IFA	A1504T	A1000T2BNW	A2004T2BNW	
A1000IF	A1500IFBNW	A0504T2BNW	A1504T2	A2404IFB	A1504TA	A1500T2	A2404T2B	
A1000IFA	A1500T	A0754IFA	A1504T2B	A2404IFBNW	A1504T2	A1500T2B	A2404T2BNW	
A1000IFB	A1500TA	A0754IFB	A1504T2BNW	A2404T	A2004T			
A1000IFBNW	A1500T2	A0754IFBNW	A2004IF	A2404TA	A2004TA			
A1000T	A1500T2B	A1004IF	A2004IFA	A2404T2	A2404T			
A1000TA	A1500T2BNW	A1004IFA	A2004IFB	A2404T2B	A2404TA			
		A1004IFB	A2004IFBNW	A2404T2BNW	A2404T2			
		A1004IFBNW	A2004T					

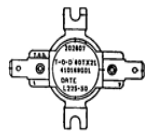

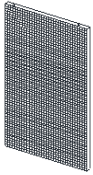
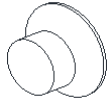
CRA SERIES									
KNOB		GRILLE	LIGHT				ELEMENT		
									
<b>3301-2039-002</b>		<b>2501-2065-000</b>	<b>3510-2017-000</b>	<b>3510-2017-001</b>	<b>3510-2017-002</b>	<b>3510-2017-003</b>	<b>1802-2124-005</b>	<b>1802-2124-000</b>	<b>1802-2124-003</b>
C1012T2 C1024T2 C1512T2 C1524T2 C2024T2 C2028T2 C2224T2 C1012T2A C1024T2A C1512T2A C1524T2A C2024T2A C2028T2A C2224T2A	C1012T2AA C1512T2AB C1012T2AB C1024T2AB C1512T2AB C1524T2AB C2024T2AB C2028T2AB C2224T2AB C1512T2A C1512T2B C2024T2B C2224T2B C1512T2A C1512T2B C2024T2B C2224T2B C1512T2C C2024T2C C2028T2C C2224T2C	C1512FB C1512T2B C2024FB C2024T2B C2028FB C2224FB C2224T2B C1512FC C1512T2C C2024FC C2024T2C C1512FA C1512T2A C1512T2AA C2028T2A C2024T2A C2024T2C	C1012IF C1012T2 C1512IF C1512T2 C1012IFA C1012T2A C1512IFA C1512T2A C1012IFAA C1012T2AA C1512IFAA C1512T2AA C1012IFAB C1012T2AB C2024IFA C2024T2A C2028IFA C2028T2A C2224IFA C2224T2A	C1024IF C1024T2 C1524IF C1524T2 C2024IF C2024T2 C2028IF C2028T2 C2224IF C2224T2 C1024IFA C1024T2A C1524IFA C1524T2A C2024IFA C2024T2A C2028IFA C2028T2A C2224IFA C2224T2A	C1512IFAB C1512T2AB C1512IFB C1512T2B C1512IFC C1512T2C	C1024IFAB C1024T2AB C1524IFAB C1524T2AB C2024IFAB C2024T2AB C2028IFAB C2028T2AB C2224IFAB C2224T2AB C2024IFB C2024T2B C2024T2C C2028IFB C2028T2C C2224IFC C2224T2C	C1024IF C1024T2 C2024IF C2024T2 C1024IFA C1024T2A C2024IFA C2024T2A C2028IFA C2028T2A C2224IFA C2224T2A	C1512IF C1512T2 C1512IFA C1512T2A C2024IFA C2024T2A C2028IFA C2028T2A C2224IFA C2224T2A	C1012IFA C1012T2A C1512IFA C1512T2A C1012IFAA C1012T2AA C1512IFAA C1512T2AA C1012IFAB C1012T2AB C1512IFAB C1512T2AB C1512IFB C1512T2B C1512IFC C1512T2C
							MODELS NOT LISTED ARE OBSOLETE		
<b>FAN BLADE</b>		<b>MOTOR</b>				<b>HI LIMIT</b>			<b>CLIP N FIT BOARD</b>
									
<b>1210-2008-000</b> ALL MODELS		<b>3900-2017-000</b>	<b>3900-2017-001</b>	<b>3900-2035-000</b>	<b>4520-11007-000</b>	<b>4520-11007-001</b>	<b>4520-2059-000</b>		<b>1249-2005-000</b>
C1012IF C1012T2 C1512IF C1512T2 C1012IFA C1012T2A C1512IFA C1512T2A C1012IFAA C1012T2AA C1512IFAA C1512T2AA C1012IFAB C1012T2AB C1512IFAB C1512T2AB C1512IFB C1512T2B C1512IFC C1512T2C		C1012IF C1024T2 C1524IF C1524T2 C2024IF C2024T2 C2028T2A C1024IFA C1024T2A C1524IFA C1524T2A C1024IFAA C1524T2A C2024IFA C1024IFAB C1024T2AB C1524IFAB C1524T2AB C2024IFAB C2024T2B C2024IFB C2024T2B C2024T2C	C1024IF C2028T2 C2224IF C2224T2 C2028IFA C2028T2A C2224IFA C2224T2A C1524IFA C2028IFAB C2224IFB C2224T2B C2028IFC C2028T2C	C2028IF C2028T2 C2224IF C2224T2 C2028IFA C2224IFAB C2224T2A C2028IFB C2224IFB C2028IFC C2224T2C	C1512IFC C1512T2C	C2024IFC C2024T2C C2028IFC C2224IFC C2224T2C	C1012IF C1012T2 C1512IF C1512T2 C1012IFA C1012T2A C1512IFA C1512T2A C1512T2A C1012IFAA C1012T2AA C1512IFAA C1512T2AA C1012IFAB C1012T2AB C1512IFAB C1512T2AB C1512IFB C1512T2B C1024IF C1024T2 C1524IF C1524T2	C2024IFA C2224T2A C2028IFAB C2224IFAB C2224T2AB C2028IFB C2224IFB C2224T2B C1024IFAB C1024T2AB C1524IFAB C1524T2AB C1524T2AB C2024IFAB C2024T2AB C2024IFB C2024T2B C2028IF C2028T2 C2224IF C2224T2 C2028IFA C2028T2A	C1512IFB C1512T2B C2024IFB C2024T2C C2028IFC C2224IFC C2224T2C
<b>THERMOSTAT</b>		<b>THERMAL FUSE</b>							
									
<b>410130001</b>		<b>5813-2090-000</b>	<b>4520-2030-000</b>						
C1012T2 C1512T2 C1012T2A C1512T2A C1012T2AA C1512T2AA C1024T2 C1524T2 C2024T2 C1024T2A C1524T2A C2024T2A C2028T2 C2224T2 C2028T2A C2224T2A	C1012T2AB C1512T2AB C1512T2B C1512T2C C1024T2AB C1524T2AB C2024T2AB C2024T2B C2024T2C C2224T2AB C2224T2C	C1012FAA C1012T2AA C1512FAA C1512T2AA C1012FAB C1012T2AB C1512FAB C1512T2AB C2024FAB C2024T2B C2024IFB C2024T2B C2024T2C	C1512FB C1512T2B C2024FB C2024T2B C2028FB C2224FB C2224T2B C1512FC C1512T2C C1012FA C1012T2A C1512FA C1512T2A C1012FAB C1012T2AB C1512FAB C1512T2AB C2024FAB C2024T2B C2024IFB C2024T2B C2028IFC C2224IFC C2224T2C	C1512IFB C1512T2B C2024IFB C2024T2B C2028IFB C2224IFB C2224T2B C1512IFC C1512T2C C1012IFA C1012T2A C1512IFA C1512T2A C1012IFAB C1012T2AB C1512IFAB C1512T2AB C2024IFAB C2024T2B C2024IFB C2024T2B C2028IFC C2224IFC C2224T2C	C1512IFB C1512T2B C2024IFB C2024T2B C2028IFB C2224IFB C2224T2B C1512IFC C1512T2C C1012IFA C1012T2A C1512IFA C1512T2A C1012IFAB C1012T2AB C1512IFAB C1512T2AB C2024IFAB C2024T2B C2024IFB C2024T2B C2028IFC C2224IFC C2224T2C	C1512IFB C1512T2B C2024IFB C2024T2B C2028IFB C2224IFB C2224T2B C1512IFC C1512T2C C1012IFA C1012T2A C1512IFA C1512T2A C1012IFAB C1012T2AB C1512IFAB C1512T2AB C2024IFAB C2024T2B C2024IFB C2024T2B C2028IFC C2224IFC C2224T2C	C1512IFB C1512T2B C2024IFB C2024T2B C2028IFB C2224IFB C2224T2B C1512IFC C1512T2C C1012IFA C1012T2A C1512IFA C1512T2A C1012IFAB C1012T2AB C1512IFAB C1512T2AB C2024IFAB C2024T2B C2024IFB C2024T2B C2028IFC C2224IFC C2224T2C	C1512IFB C1512T2B C2024IFB C2024T2B C2028IFB C2224IFB C2224T2B C1512IFC C1512T2C C1012IFA C1012T2A C1512IFA C1512T2A C1012IFAB C1012T2AB C1512IFAB C1512T2AB C2024IFAB C2024T2B C2024IFB C2024T2B C2028IFC C2224IFC C2224T2C	
									

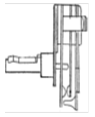
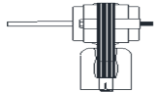
BVP					
MOTOR				LIMIT	
					
<b>42528-052-01</b>		<b>42528-052-02</b>		<b>4520-2025-000</b>	
VP1222	VP1222I	VP2022	VP2022I	VP1222C	VP2022IC
VP1222A	VP1222IB	VP2022A	VP2022IB	VP1222CNW	VP2022ICNW
VP1222AI	VP1222IBP	VP2022AI	VP2022IBP	VP1222IC	VP2422C
VP1222B	VP1222IC	VP2022B	VP2022IC	VP1222ICNW	VP2422CNW
VP1222C	VP1222ICNW	VP2022C	VP2022ICNW	VP2022C	VP2422IC
VP1222CNW		VP2022CNW		VP2022CNW	VP2422ICNW

A2500					
THERMOSTAT	ELEMENT	LIMIT	THERMAL FUSE	GRILLE	MOTOR
				PICTURE NOT AVAILABLE	
<b>1230-8232</b>	<b>6101-8752</b>	<b>8541-8056</b>	<b>8671-8037</b>	<b>8683-8272</b>	<b>8767-8036</b>
A2515T	A2530T	A2515T	A2515T	A2515T	A2515T
A2520T		A2520T	A2520T	A2520T	A2520T
A2530T		A2530T	A2530T	A2530T	A2530T
A2540T		A2540T	A2540T	A2540T	A2540T
A2548T		A2548T	A2548T	A2548T	A2548T

SCH SERIES						
ELEMENT						
						
<b>302023801</b>	<b>302023802</b>	<b>302023803</b>	<b>302023804</b>	<b>302023805</b>	<b>302023806</b>	<b>302023807</b>
SCH1012IF	SCH1512IF	SCH1527IF	SCH2020IF	SCH2024IF	SCH2027IF	SCH2012IF
SCH1012W	SCH1512W	SCH1527W	SCH2020W	SCH2024W	SCH2027W	SCH2012W
MOTOR			BLADE	FAN DELAY	LIMIT	
						
<b>490062001</b>	<b>490062002</b>	<b>490062003</b>	<b>490062004</b>	<b>490061001</b>	<b>410074000</b>	<b>410169001</b>
SCH1012IF	SCH2020IF	SCH2024IF	SCH1527IF	ALL MODELS	ALL MODELS	ALL MODELS
SCH1012W	SCH2020W	SCH2024W	SCH1527W			
SCH1512IF			SCH2027IF			
SCH1512W			SCH2027W			
SCH2012IF						
SCH2012W						

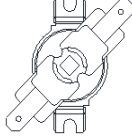
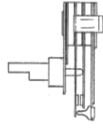
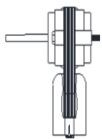
1235 & 2435 SERIES (OBS)					
SCREEN		KNOB	FACE PLATE	LIMIT	
					
<b>1235-0037</b> 1235 2435	<b>8850-8046</b> 1235P 2435P	<b>3301-2047-000</b> ALL MODELS	<b>4503-2094-000</b> ALL MODELS	<b>8541-8054</b> ALL MODELS	
THERMOSTAT	MOTOR	FAN BLADE	ELEMENT	THERMAL FUSE	
					
<b>1230-8194</b> ALL MODELS	<b>1235-0007</b> ALL MODELS	<b>1235-0008</b> ALL MODELS	<b>6101-8741</b> ALL MODELS	<b>8671-8036</b> 2435 2435P	

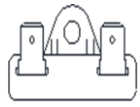
B2400 SERIES (OBS)			
ELEMENT		LIMIT	THERMOSTAT
			
<b>6101-8741</b> B2451	<b>6101-8742</b> B2452	<b>8541-8055</b> ALL MODELS	<b>1230-8206</b> ALL MODELS
MOTOR		FAN BLADE	THERMAL FUSE
			
<b>8767-8035</b> B2451	<b>8767-8036</b> B2452	<b>991-313</b> ALL MODELS	<b>8671-8037</b> B2452

**SR SERIES (OBSOLETE)**

**ELEMENT**



<b>302023801</b> SR1012IFLTC SR1012IFLTP SR1012IFLTPB SR1012IFP SR1012LTC SR1012LTP SR1012LTPB SR1012P	<b>302023802</b> SR1512CKJCP SR1512IFLTC SR1512IFLTP SR1512IFLTPB SR1512IFP SR1512IFPB SR1512LTC SR1512LTP SR1512LTPB SR1512P	<b>302023803</b> SR1527IFLTC SR1527IFLTP SR1527IFLTPB SR1527IFP SR1527IFPB SR1527LTC SR1527LTP SR1527LTPB SR1527P	<b>302023804</b> SR2020IFLTC SR2020IFLTP SR2020IFLTPB SR2020IFP SR2020LTC SR2020LTP SR2020LTPB SR2020P	<b>302023805</b> SR2024IFLTC SR2024IFLTP SR2024IFLTPB SR2024IFP SR2024LTC SR2024LTP SR2024LTPB SR2024P	<b>302023806</b> SR2027IFLTC SR2027IFLTP SR2027IFLTPB SR2027IFP SR2027LTC SR2027LTP SR2027LTPB SR2027P	<b>302023807</b> SR2012IFLTC SR2012IFLTP SR2012IFLTPB SR2012IFP SR2012LTC SR2012LTP SR2012LTPB SR2012P
--	---	--	--	--	--	--

**KNOB**



**THERMOSTAT**



**FAN DELAY**



SR1012C SR1012IFC SR1012IFP SR1012IFPB SR1012P SR1012PB SR1512C SR1512CKJCP SR1512IFC SR1512IFP SR1512IFPB SR1512P SR1512PB SR1527C SR1527IFC	<b>3301-2020-008</b> SR1527IFP SR1527IFPB SR1527P SR1527PB SR2012C SR2012IFC SR2012IFP SR2012IFPB SR2012P SR2012PB SR2020C SR2020IFC SR2020IFP SR2020IFPB SR2020P	SR2020PB SR2024C SR2024IFC SR2024IFP SR2024IFPB SR2024P SR2024PB SR2027C SR2027IFC SR2027IFP SR2027IFPB SR2027P SR2027PB	SR1012C SR1012IFC SR1012IFP SR1012IFPB SR1012P SR1012PB SR1512C SR1512CKJCP SR1512IFC SR1512IFP SR1512IFPB SR1512P SR1512PB SR1527C SR1527IFC	<b>5813-2027-000</b> SR1527IFP SR1527IFPB SR1527P SR1527PB SR2012C SR2012IFC SR2012IFP SR2012IFPB SR2012P SR2012PB SR2020C SR2020IFC SR2020IFP SR2020IFPB SR2020P	SR2020PB SR2024C SR2024IFC SR2024IFP SR2024IFPB SR2024P SR2024PB SR2027C SR2027IFC SR2027IFP SR2027IFPB SR2027P SR2027PB	<b>410074000</b> ALL MODELS
---	--	--	---	--	--	--------------------------------

**BLADE**





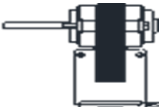





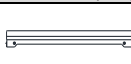

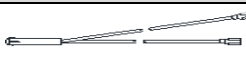

**MOTOR**





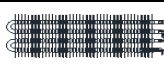

SR1012IFLTC SR1012IFLTP SR1012IFLTPB SR1012IFP SR1012LTC SR1012LTP SR1012LTPB SR1012P SR1512CKJCP SR1512IFLTC SR1512IFLTP SR1512IFLTPB SR1512IFP SR1512LTC SR1512LTP SR1512LTPB SR1512P SR1527IFLTC SR1527IFLTP SR1527IFLTPB SR1527IFP SR1527LTC	<b>490061001</b> SR1527LTP SR1527LTPB SR1527P SR2012IFLTC SR2012IFLTP SR2012IFLTPB SR2012IFP SR2012LTC SR2012LTP SR2012LTPB SR2012P SR2012PB SR2020IFLTC SR2020IFLTP SR2020IFLTPB SR2020IFP SR2020LTC SR2020LTP SR2020LTPB SR2020P SR2024IFLTC SR2024IFLTP SR2024IFLTPB SR2024IFP	SR2024IFP SR2024LTC SR2024LTP SR2024LTPB SR2024P SR2027IFLTC SR2027IFLTP SR2027IFLTPB SR2027IFP SR2027LTC SR2027LTP SR2027LTPB SR2027P	SR1012IFLTC SR1012IFLTP SR1012IFLTPB SR1012IFP SR1012LTC SR1012LTP SR1012LTPB SR1012P SR1512CKJCP SR1512IFLTC SR1512IFLTP SR1512IFLTPB SR1512IFP	<b>490062001</b> SR1512LTC SR1512LTP SR1512LTPB SR1512P SR2012IFLTC SR2012IFLTP SR2012IFLTPB SR2012IFP SR2012LTC SR2012LTP SR2012LTPB SR2012P	<b>490062002</b> SR2020IFLTC SR2020IFLTP SR2020IFLTPB SR2020IFP SR2020LTC SR2020LTP SR2020LTPB SR2020P	<b>490062003</b> SR2024IFLTC SR2024IFLTP SR2024IFLTPB SR2024IFP SR2024LTC SR2024LTP SR2024LTPB SR2024P	<b>490062004</b> SR1527IFLTC SR1527IFLTP SR1527IFLTPB SR1527IFP SR1527LTC SR1527LTP SR1527LTPB SR1527P SR2027IFLTC SR2027IFLTP SR2027IFLTPB SR2027IFP SR2027LTC SR2027LTP SR2027LTPB SR2027P
---	---	--	--	---	--	--	--





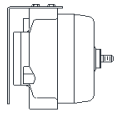
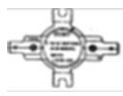







SRA SERIES WALL HEATER (OBS)

SRA SERIES WALL HEATER (OBS)									
GRILLE	PLASTIC COVER(2REQ)	KNOB	FAN BLADE	LIGHT				THERMAL FUSE	
									
<b>1402-2117-001</b> ALL MODELS	<b>1402-2119-000</b> ALL MODELS	<b>3301-2014-001</b> ALL MODELS	<b>490061001</b> ALL MODELS	<b>3510-2008-003</b> SRA1012B SRA1512B SRA1812B SRA1012DSB SRA1512DSB SRA1812DSB	<b>3510-2008-002</b> SRA1527B SRA2020B SRA2024B SRA2027B SRA1527DSB SRA2020DSB SRA2024DSB SRA2027DSB	<b>3510-2008-006</b> SRA1012DSC SRA1512DSC SRA1812DSC	<b>3510-2008-007</b> SRA1527DSC SRA2020DSC SRA2024DSC SRA2027DSC	<b>4520-2030-000</b> SRA1012DSC SRA1512DSC SRA1527DSC SRA1812DSC SRA2020DSC SRA2024DSC SRA2027DSC	
THERMOSTAT		MANUAL LIMIT	DISCONNECT SW.	FAN DELAY		HI LIMIT			
									
<b>5813-2001-000</b>		<b>5813-2022-000</b>	<b>4520-11016-000</b>	<b>410170001</b>	<b>410074000</b>		<b>410143000</b>		
SRA1012 SRA1012IF SRA1012A SRA1012B SRA1012DS SRA1012DSB SRA1012DSC SRA1512 SRA1512IF SRA1512A SRA1512B SRA1512DS SRA1512DSB SRA1512DSC SRA1527 SRA1527IF SRA1527A SRA1527B SRA1527DS SRA1527DSB SRA1527DSC	SRA1812DSC SRA2020 SRA2020IF SRA2020A SRA2020B SRA2020DSB SRA2020DSC SRA2024 SRA2024IF SRA2024A SRA2024B SRA2024DS SRA2024DSB SRA2024DSC SRA2027 SRA2027A SRA2027B SRA2027DS SRA2027DSB SRA2027DSC	SRA1812 SRA1812IF SRA1812A SRA1812B SRA1812DSB	SRA1012A SRA1512A SRA1527A SRA1812A SRA2020A SRA2024A SRA2027A SRA1012DS SRA1512DS SRA2024DS SRA1527DSC SRA1812DSC SRA2020DSC SRA2024DSC SRA1527DSC SRA2027DSC SRA2027DS SRA2027DSC	SRA1012DS SRA1012DSB SRA1012DSC SRA1512DS SRA1512DSB SRA1512DSC SRA1527DSB SRA1527DSC SRA1812DSC SRA1512DSC SRA1527DSB SRA1527DSC SRA1812DSC SRA2020DSC SRA2024DSC SRA1527DSC SRA2027DSC SRA1812 SRA1812IF	SRA1012 SRA1812B SRA1012IF SRA1012B SRA1012DSB SRA2020 SRA2020IF SRA1512 SRA2020B SRA1512IF SRA2024 SRA2024IF SRA1527 SRA2024B SRA2024DSB SRA1527B SRA2027 SRA2027B SRA2027DSB SRA2027DSC	SRA1012 SRA1512 SRA1527 SRA1812 SRA2020 SRA2024 SRA2027 SRA1012IF SRA1512IF SRA1527IF SRA1812IF SRA2020IF SRA2024IF	SRA1012B SRA1512B SRA1527B SRA1812B SRA2020B SRA2024B SRA2027B SRA1012DSB SRA1512DSB SRA1527DSB SRA1812DSB SRA2020DSB SRA2024DSB SRA2027DSB		
MOTOR				ELEMENT					
									
<b>490062001</b> SRA1012 SRA1512 SRA1812 SRA1012IF SRA1512IF SRA1812IF SRA1012A SRA1812A SRA1512B SRA1812B SRA1012DS SRA1512DS SRA1012DSB SRA1512DSB SRA1812DSB SRA1012DSC SRA1512DSC SRA1812DSC	<b>490062002</b> SRA2020 SRA2020IF SRA2020A SRA2020B SRA2020DSB SRA2020DSC	<b>490062003</b> SRA2024 SRA2024IF SRA2024A SRA2024B SRA2024DS SRA2024DSC	<b>490062004</b> SRA1527 SRA2027 SRA1527IF SRA1527A SRA2027A SRA1527B SRA2027B SRA2027DS SRA1527DSB SRA2027DSB SRA1527DSC SRA2027DSC	<b>302023801</b> SRA1012 SRA1012IF SRA1012A SRA1012B SRA1012DS SRA1012DSB SRA1012DSC  <b>302023802</b> SRA1512 SRA1512IF SRA1512A SRA1512B SRA1512DS SRA1512DSB	<b>302023803</b> SRA1527 SRA1527IF SRA1527A SRA1527B SRA1527DSB SRA1527DSC  <b>302023808</b> SRA1812 SRA1812IF SRA1812A SRA1812B SRA1812DSB SRA1812DSC  <b>302023806</b> SRA2027 SRA2027A SRA2027B SRA2027DS SRA2027DSB SRA2027DSC	<b>302023804</b> SRA2020 SRA2020IF SRA2020A SRA2020B SRA2020DSB SRA2020DSC  <b>302023805</b> SRA2024 SRA2024IF SRA2024A SRA2024B SRA2024DS SRA2024DSB SRA2024DSC			









**FR SERIES (OBSOLETE)**



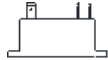
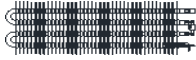





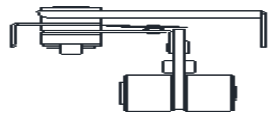

ELEMENT					THERMOSTAT				
									
<b>302015806</b> FR1527 FR1527A FR1527AIF FR1527IF FR1527LT FR1527LTIF FR1527LTPB FR1527PB	<b>302015801</b> FR2020 FR2020A FR2020AIF FR2020IF FR2020LT FR2020LTIF FR2020LTPB FR2020PB	<b>302015802</b> FR2024 FR2024A FR2024AIF FR2024IF FR2024LT FR2024LTIF FR2024LTPB FR2024PB	<b>302015803</b> FR2027 FR2027A FR2027AIF FR2027IF FR2027LT FR2027LTIF FR2027LTPB FR2027PB	<b>302012806</b> FR3027 FR3027A FR3027AIF FR3027IF FR3027LT FR3027LTIF FR3027LTPB FR3027PB	FR1527 FR1527A FR1527AIF FR1527IF FR1527PB FR2020 FR2020A FR2020AIF FR2020IF FR2020PB FR2024 FR2024A FR2024AIF FR2024IF FR2024PB FR2027 FR2027A	<b>410168002</b> FR2027AIF FR2027IF FR2027PB FR3027 FR3027A FR3027AIF FR3027IF FR4020 FR4020A FR4020AIF FR4020IF FR4020PB FR4024 FR4024A FR4024AIF FR4024IF FR4024PB FR4027A FR4027AIF FR4027IF FR4027PB FR4824 FR4824A FR4824AIF FR4824IF FR4824PB FR4827A FR4827AIF FR4827IF FR4827PB FR4827PB	FR4024PB FR4027 FR4027A FR4027AIF FR4027IF FR4027PB FR4824 FR4824A FR4824AIF FR4824IF FR4824PB FR4827A FR4827AIF FR4827IF FR4827PB		
<b>302012807</b> FR4020 FR4020A FR4020AIF FR4020IF FR4020LT FR4020LTIF FR4020LTPB FR4020PB	<b>302012808</b> FR4024 FR4024A FR4024AIF FR4024IF FR4024LT FR4024LTIF FR4024LTPB FR4024PB	<b>302012809</b> FR4027 FR4027A FR4027AIF FR4027IF FR4027LT FR4027LTIF FR4027LTPB FR4027PB	<b>302012810</b> FR4824 FR4824A FR4824AIF FR4824IF FR4824LT FR4824LTIF FR4824LTPB FR4824PB	<b>302012811</b> FR4827 FR4827A FR4827AIF FR4827IF FR4827LT FR4827LTIF FR4827LTPB FR4827PB	FR2020AIF FR2020IF FR2020PB FR2024 FR2024A FR2024AIF FR2024IF FR2024PB FR2027 FR2027A	FR4020 FR4020A FR4020AIF FR4020IF FR4020PB FR4024 FR4024A FR4024AIF FR4024IF FR4024PB FR4027A FR4027AIF FR4027IF FR4027PB FR4824 FR4824A FR4824AIF FR4824IF FR4824PB FR4827A FR4827AIF FR4827IF FR4827PB	FR4824AIF FR4824IF FR4824PB FR4827A FR4827AIF FR4827IF FR4827PB		
MOTOR					LIMIT	FAN DELAY			
									
<b>490064001</b> FR2020 FR2020IF FR2020LT FR2020LTIF FR2020LTPB FR2020PB FR2024 FR2024IF FR2024LT FR2024LTIF FR2024LTPB FR2024PB FR4020 FR4020IF FR4020LT		<b>490064003</b> FR1527 FR1527IF FR1527LT FR1527LTIF FR1527LTPB FR1527PB FR2027 FR2027IF FR2027LT FR2027LTIF FR2027LTPB FR2027PB FR4824 FR4824IF FR4824LT FR4824LTIF FR4824LTPB FR4824PB FR3027 FR3027IF FR3027LT		<b>3900-2002-502</b> FR2020A FR2020AIF FR2024 FR2024AIF FR4020 FR4020AIF FR4024A FR4024AIF FR4824A FR4824AIF		<b>3900-2002-503</b> FR1527A FR1527AIF FR2027A FR2027AIF FR3027A FR3027AIF FR4027A FR4027AIF FR4827A FR4827AIF		<b>410169001</b> ALL MODELS <b>BLADE</b>  <b>490030103</b> ALL MODELS	<b>410074000</b> ALL MODELS

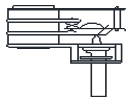
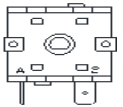

FRA SERIES WALL HEATER (OBSOLETE)									
GRILLE		ELEMENT				RELAY			
									
<b>1402-2241-001</b>		<b>302012806</b>	<b>302012809</b>	<b>302015801</b>	<b>302015806</b>	<b>1802-2075-800</b>	<b>5018-2017-004</b>	<b>5018-2017-000</b>	
FRA2020B	FRA4024B	FRA3027	FRA4027	FRA2020	FRA1527	FRA40203	FRA40203	FRA40243	
FRA2024B	FRA40243B	FRA3027A	FRA4027A	FRA2020A	FRA1527A	FRA40203B	FRA4820	FRA48243	
FRA2027B	FRA4027B	FRA3027B	FRA4027B	FRA2020B	FRA1527B	<b>1802-2075-801</b>	FRA48203	FRA40243B	
FRA1512	FRA4820B	<b>302012807</b>	<b>302012811</b>	<b>302015802</b>	<b>302012827</b>	FRA4820	FRA48203	FRA48243B	
FRA1812	FRA48203B	FRA4020	FRA4827	FRA2024	FRA1512	FRA48203	FRA48203B		
FRA3027B	FRA4824B	FRA4020A	FRA4827A	FRA2024A	<b>302012828</b>	FRA4820B	FRA48203B		
FRA4020B	FRA48243B	FRA4020B	FRA4827B	FRA2024B	FRA1812	FRA48203B			
FRA40203B	FRA4827B	FRA4020T2	<b>302012810</b>	FRA2024T2		<b>1802-2075-802</b>			
		FRA4020T2A	FRA4824	FRA2024T2A		FRA40243			
		<b>302012808</b>	FRA4824A	<b>302015803</b>		FRA40243B			
		FRA4024	FRA4824B	FRA2027		<b>1802-2075-803</b>			
		FRA4024A	FRA4824T2	FRA2027A		FRA48243B			
		FRA4024B	FRA4824T2A	FRA2027B					
		FRA4024T2							
		FRA4024T2A							
MANUAL LIMIT		HI LIMIT	MOTOR			FAN DELAY			
									
<b>4520-2027-000</b>		<b>410169001</b>	<b>3900-2002-501</b>	<b>3900-2002-500</b>	<b>3900-2002-518</b>	<b>4520-2024-000</b>		<b>410074000</b>	
FRA40203	FRA2027B	FRA1527	FRA1527	FRA2020	FRA40203	FRA40203	FRA40203	FRA4824	
FRA40243	FRA1512	FRA2020	FRA2027	FRA2024	FRA40243	FRA40243	FRA3027B	FRA4824A	
FRA4820	FRA1812	FRA2024	FRA3027	FRA4020	FRA4820	FRA4820	FRA4020	FRA4824B	
FRA48203	FRA3027B	FRA2027	FRA4027	FRA4024	FRA48203	FRA48203	FRA2020	FRA4824T2	
FRA48243	FRA4020B	FRA3027	FRA4827	FRA4824	FRA48243	FRA48243	FRA2020A	FRA4824T2A	
FRA1527A	FRA40203B	FRA4020	<b>3900-2010-000</b>	FRA2024T2	FRA40203B	FRA48203B	FRA2020B	FRA4827	
FRA2020A	FRA4024B	FRA4024	FRA2020A	FRA4020T2	FRA40243B	FRA48203B	FRA2024	FRA4020T2A	
FRA2024A	FRA40243B	FRA4027	FRA2024A	FRA4024T2	FRA4820B	FRA48203B	FRA2024A	FRA4024	
FRA2027A	FRA4027B	FRA4824	FRA4020A	FRA4824T2	FRA48203B	FRA48203B	FRA2024B	FRA4024A	
FRA3027A	FRA4820B	FRA4827	FRA4024A	<b>3900-2010-001</b>	FRA1527	FRA48243B	FRA2024T2	FRA4024B	
FRA4020A	FRA48203B	FRA2024T2	FRA4824A	FRA1527	FRA2027A	FRA1512	FRA2024T2A	FRA4024T2	
FRA4024A	FRA4824B	FRA2020B	FRA2020B	FRA2027A	FRA3027A	FRA1812	FRA2027	FRA4024T2A	
FRA4027A	FRA48243B	FRA2024B	FRA2024B	FRA3027A	FRA4027A		FRA2027A	FRA4027	
FRA4824A	FRA4827B	FRA4020B	FRA4020B	FRA4027A	FRA4827A		FRA2027B	FRA4027A	
FRA4827A	FRA2024T2A	FRA4024B	FRA4024B	FRA4827A	FRA4827B		FRA3027	FRA4027B	
FRA1527B	FRA4020T2A	FRA4824B	FRA4824B	FRA1527B	FRA1527B			FRA1812	
FRA2020B	FRA4024T2A	FRA2020T2A	FRA2020T2A	FRA2027B	FRA2027B				
FRA2024B	FRA4824T2A	FRA4020T2A	FRA4020T2A	FRA3027B	FRA3027B				
		FRA4024T2A	FRA4024T2A	FRA4027B	FRA4027B				
		FRA4824T2A	FRA4824T2A	FRA4827B	FRA4827B				
THERMOSTAT		DISCONNECT SWITCH			FAN BLADE	PLASTIC COVER(2REQ)	KNOB		
									
<b>410168002</b>	<b>5813-2059-000</b>	<b>5813-2027-000</b>	<b>5216-2019-000</b>	<b>410170001</b>	<b>490030103</b>	<b>1402-2120-000</b>	<b>3301-2014-001</b>		
FRA1527	FRA1527B	FRA2024T2	FRA40203	FRA1527	ALL MODELS	ALL MODELS	ALL MODELS		
FRA2020	FRA2020B	FRA4020T2	FRA40243	FRA2020					
FRA2024	FRA2024B	FRA4024T2	FRA4820	FRA2024					
FRA2027	FRA2027B	FRA4824T2	FRA48203	FRA2027					
FRA3027	FRA1512	FRA2024T2A	FRA48243	FRA3027					
FRA4020	FRA1812	FRA4020T2A	FRA40203B	FRA4020					
FRA40203	FRA3027B	FRA4024T2A	FRA40243B	FRA4024					
FRA4024	FRA4020B	FRA4024T2A	FRA4820B	FRA4027					
FRA40243	FRA40203B	FRA4824T2A	FRA48203B	FRA4824					
FRA4027	FRA4024B		FRA48243B	FRA4827					
FRA4820	FRA40243B			FRA1527A					
FRA48203	FRA4027B			FRA2020A					
FRA4824	FRA4820B			FRA2024A					
FRA48243	FRA48203B			FRA2027A					
FRA4827	FRA4824B			FRA3027A					
FRA1527A	FRA48243B			FRA4020A					
FRA2020A	FRA4827B			FRA4024A					
FRA2024A				FRA4027A					
FRA2027A				FRA4824A					
FRA3027A				FRA4827A					
FRA4020A									
FRA4024A									
FRA4027A									
FRA4824A									
FRA4827A									

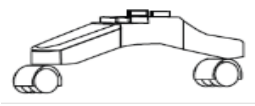

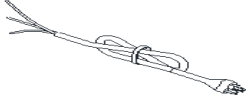



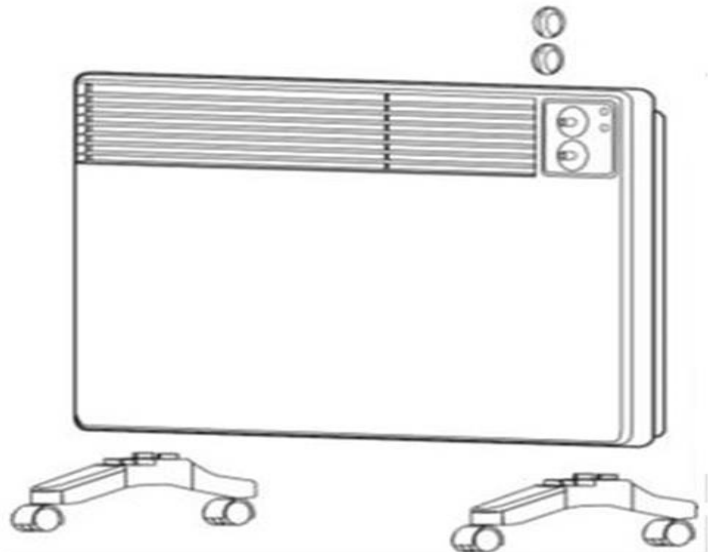



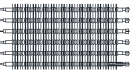

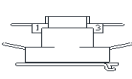

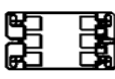

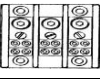

FRC SERIES (OBSOLETE)											
GRILLE				FAN DELAY				RELAY			
											
<b>2501-2003-007</b>				<b>4520-2024-000</b>				<b>410074000</b>		<b>5018-2017-004</b>	<b>5018-2017-000</b>
FRC40203	FRC2027AIF	FRC4827AIF	FRC2020C	FRC40203	FRC1527	FRC1527B	FRC1527A	FRC40203	FRC40243		
FRC40243	FRC3027A	FRC1527B	FRC2024C	FRC40243	FRC1527IF	FRC2027B	FRC1527AIF	FRC4820	FRC48243		
FRC4820	FRC3027AIF	FRC2020B	FRC2027C	FRC4820	FRC2027	FRC3027B	FRC3027A	FRC48203	FRC40243C		
FRC48203	FRC4020A	FRC2024B	FRC3027C	FRC48203	FRC2027IF	FRC4027B	FRC3027AIF	FRC40203C	FRC48243C		
FRC48243	FRC4020AIF	FRC2027B	FRC4020C	FRC48243	FRC3027	FRC4827B	FRC4027A	FRC4820C			
FRC1527A	FRC4024A	FRC3027B	FRC40203C	FRC40203C	FRC3027IF	FRC1527C	FRC4027AIF	FRC48203C			
FRC1527AIF	FRC4024AIF	FRC4020B	FRC4024C	FRC40243C	FRC4027	FRC2027C	FRC4827A				
FRC2020A	FRC4027A	FRC4024B	FRC40243C	FRC4820C	FRC4027IF	FRC3027C	FRC4827AIF				
FRC2020AIF	FRC4027AIF	FRC4027B	FRC4027C	FRC48203C	FRC4827	FRC4027C	FRC2020A				
FRC2024A	FRC4824A	FRC4824B	FRC4820C	FRC48243C	FRC4827IF	FRC4827C	FRC2020AIF				
FRC2024AIF	FRC4824AIF	FRC4827B	FRC48203C		FRC2020	FRC2020B	FRC2024A				
FRC2027A	FRC4827A	FRC1527C	FRC4824C		FRC2020IF	FRC2024B	FRC2024AIF				
			FRC48243C		FRC4020	FRC4020B	FRC4020A				
			FRC4827C		FRC4020IF	FRC4024B	FRC4020AIF				
					FRC2024	FRC4824B	FRC4024A				
					FRC2024IF	FRC2020C	FRC4024AIF				
					FRC4024	FRC2024C	FRC4824A				
					FRC4024IF	FRC4020C	FRC4824AIF				
					FRC4824	FRC4024C					
					FRC4824IF	FRC4824C					
ELEMENTS				MOTOR				FAN BLADE	THERMOSTAT		
											
<b>302015806</b>	<b>302015801</b>	<b>302015802</b>	<b>302015803</b>	<b>490064003</b>	<b>3900-2010-001</b>	<b>3900-2002-501</b>	<b>3900-2002-518</b>	<b>490030103</b>	<b>410168002</b>		
FRC1527	FRC2020	FRC2024	FRC2027	FRC1527	FRC1527B	FRC1527A	FRC40203	ALL MODELS	ALL MODELS		
FRC1527IF	FRC2020IF	FRC2024IF	FRC2027IF	FRC1527IF	FRC2027B	FRC1527AIF	FRC40243				
FRC1527A	FRC2020A	FRC2024A	FRC2027A	FRC2027	FRC3027B	FRC3027A	FRC4820				
FRC1527AIF	FRC2020AIF	FRC2024AIF	FRC2027AIF	FRC2027IF	FRC4027B	FRC3027AIF	FRC48203				
FRC1527B	FRC2020B	FRC2024B	FRC2027B	FRC3027	FRC4827B	FRC4027A	FRC48243				
FRC1527C	FRC2020C	FRC2024C	FRC2027C	FRC3027IF	FRC1527C	FRC4027AIF	FRC40203C				
				FRC4027	FRC2027C	FRC4827A	FRC40243C				
				FRC4027IF	FRC3027C	FRC4827AIF	FRC4820C				
				FRC4827	FRC4027C	<b>3900-2002-500</b>	FRC48203C				
				FRC4827IF	FRC4827C	FRC2020A	FRC48243C				
				<b>490064001</b>	<b>3900-2010-000</b>	FRC2020AIF	<b>490064002</b>				
				FRC2020	FRC2020B	FRC2024A	FRC2024				
				FRC2020IF	FRC2024B	FRC2024AIF	FRC2024IF				
				FRC4020	FRC4020B	FRC4020A	FRC4024				
				FRC4020IF	FRC4024B	FRC4020AIF	FRC4024IF				
					FRC4824B	FRC4024A	FRC4824				
					FRC2020C	FRC4024AIF	FRC4824IF				
					FRC2024C	FRC4824A					
					FRC4020C	FRC4824AIF					
					FRC4024C						
					FRC4824C						
DISCONNECT SWITCH				MANUAL LIMIT				HI LIMIT			
											
<b>5216-2019-000</b>	<b>410170001</b>			<b>4520-2027-000</b>				<b>410169001</b>			
FRC40203	FRC1527	FRC2020B	FRC2024A	FRC2027	FRC1527B	FRC2020C	FRC1527	FRC4027	FRC2027		
FRC40243	FRC1527IF	FRC2020C	FRC2024AIF	FRC2027IF	FRC2027B	FRC2024C	FRC1527IF	FRC4027IF	FRC2027IF		
FRC4820	FRC1527A	FRC4020	FRC2024B	FRC2027A	FRC3027B	FRC4020C	FRC1527A	FRC4027A	FRC2027A		
FRC48203	FRC1527AIF	FRC4020IF	FRC2024C	FRC2027AIF	FRC4027B	FRC4024C	FRC1527AIF	FRC4027AIF	FRC2027AIF		
FRC48243	FRC1527B	FRC4020A	FRC4824	FRC2027B	FRC4827B	FRC4824C	FRC3027	FRC2024	FRC4024		
FRC40203C	FRC1527C	FRC4020AIF	FRC4824IF	FRC2027C	FRC2020B	FRC40203	FRC3027IF	FRC2024IF	FRC4024IF		
FRC40243C	FRC3027	FRC4020B	FRC4824A	FRC4024	FRC2024B	FRC40243	FRC3027A	FRC2024A	FRC4024A		
FRC4820C	FRC3027IF	FRC4020C	FRC4824IFA	FRC4024IF	FRC4020B	FRC4820	FRC3027AIF	FRC2024AIF	FRC4024AIF		
FRC48203C	FRC3027A	FRC4027	FRC4824B	FRC4024A	FRC4024B	FRC48203	FRC2020	FRC4824			
FRC48243C	FRC3027AIF	FRC4027IF	FRC4824C	FRC4024AIF	FRC4824B	FRC48243	FRC2020IF	FRC4824IF			
	FRC3027B	FRC4027A	FRC4827	FRC4024B	FRC1527C	FRC40203C	FRC2020A	FRC4824A			
	FRC3027C	FRC4027AIF	FRC4827IF	FRC4024C	FRC2027C	FRC40243C	FRC2020AIF	FRC4824IFA			
	FRC2020	FRC4027B	FRC4827A		FRC3027C	FRC4820C	FRC4020	FRC4827			
	FRC2020IF	FRC4027C	FRC4827IFA		FRC4027C	FRC48203C	FRC4020IF	FRC4827IF			
	FRC2020A	FRC2024	FRC4827B		FRC4827C	FRC48243C	FRC4020A	FRC4827A			
	FRC2020AIF	FRC2024IF	FRC4827C				FRC4020AIF	FRC4827IFA			

WPC SERIES (OBSOLETE)			
ELEMENT	TIP OVER SW.	LIMIT	THERMOSTAT
			
1802-10822-000 WPC1500A	5216-11004-000 WPC1500A	410122002 WPC1500A	5813-2092-001 WPC1500A
1802-11017-000 (500W) 1802-11017-001 (1000W) WPC1500B WPC1500C		4520-11004-003 WPC1500B WPC1500C	WPC1500B WPC1500C
4 POSITION SW.	PORT SWITCH	LIGHT RED	PILOT LIGHT AMBER
			
5216-2071-000 WPC1500A WPC1500B WPC1500C	5216-2073-000 WPC1500A WPC1500B WPC1500C	3510-2021-002 WPC1500A 3510-2021-004 WPC1500B WPC1500C	3510-11518-000 WPC1500A WPC1500B WPC1500C
WHEEL KIT (2 REQ)	HOLE PLUG (2 REQ)	CORD	KNOB (2 REQ)
			
1205-10305-000 WPC1500A WPC1500B WPC1500C	4506-2022-000 WPC1500A WPC1500B WPC1500C	1420-2029-009 WPC1500A WPC1500B WPC1500C	3301-2058-000 WPC1500A WPC1500B WPC1500C

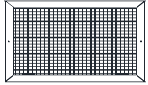

**TBX SERIES (OBS)**







ELEMENT	MOTOR	TIME DELAY RELAY	CONTACTOR 30AMP	CONTACTOR 50AMP	THERMOSTAT
					
302006814 TBX754	490059004 ALL MODELS	410171003 ALL MODELS	5018-0003-002 ALL MODELS	5018-0006-002 ALL MODELS	5813-2059-000 ALL MODELS
302006813 TBX104					
BLADE	HI LIMIT	TERMINAL BLOCK	TOOL BOX COVER	CORD	KNOB
					
490011001 ALL MODELS	410169001 ALL MODELS	480100001 ALL MODELS	<del>1016-0193-800</del> ALL MODELS	1016-10593-000 ALL MODELS	3301-2053-000 ALL MODELS
AXLE	GRILLE	COLLAPSABLE HANDLE	HANDLE	WHEEL (2 REQ)	AXLE CAP (2 REQ)
					
<del>1017-0004-000</del> ALL MODELS	<del>2501-10513-800</del> ALL MODELS	<del>2710-10586-000</del> ALL MODELS	2710-2012-800 ALL MODELS	6406-0002-000 ALL MODELS	<del>1408-10584-000</del> ALL MODELS





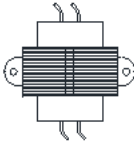

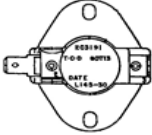
### CUH OBSOLETE

DISCRIPTION	PART NUMBERS			
	CUH3	CUH4	CUH6	CUH7
FAN MOTOR: SINGLE SHAFT DOUBLE SHAFT	3900-2032-000*	- 3900-2033-000*	3900-2032-000 3900-2033-000	- 3900-2033-000**
POWER TRANSFORMER: 277V 480V	490015009 490015010	490015009 490015010	490015007 490015008	490015007 490015008
* ONE REQUIRED ** TWO REQUIRED				
CIRCUIT BREAKERS				
REPLACEMENT CIRCUIT BREAKERS, FOR HEATERS SO EQUIPPED, ARE STANDARD, OFF-THE-SHELF ITEMS INVENTORIED BY MOST ELECTRICAL DISTRIBUTORS.				







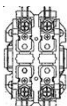
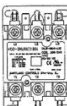
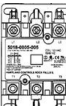
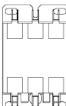
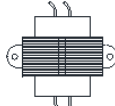

### VUH & VUH-A

BLADE	RELAY		TRANSFORMER									
												
<b>490020000</b>	<b>5018-0005-006</b>		<b>5018-0006-002</b>									
H2520 H2524 H2548 H2555 H2560 H3020 H3024 H3048 H3055 H3060 H4020 H4024 H4048 H4055 H4060	H1020A H1024A H1027A H1034A H1048A H1055A H1060A H1520A H1524A H1527A H1534A	H1048A H1555A H1560A H2020 H2024 H2027 H2034 H2048 H2055 H2060	H2520 H2524 H2548 H2555 H3020 H3024 H3048 H3055 H4020 H4024 H4048 H4055 H5020 H5024 H5060	<table border="1" style="width: 100%; border-collapse: collapse;"> <tr> <td style="text-align: center;"><b>490015018</b> H1034A H1534A</td> <td style="text-align: center;"><b>490015008</b> H5048 H5055</td> </tr> <tr> <td style="text-align: center;"><b>490015019</b> H2034</td> <td style="text-align: center;"><b>490015012</b> H2060</td> </tr> <tr> <td style="text-align: center;"><b>490015021</b> H1060A H1560A</td> <td style="text-align: center;">H2560 H3060 H4060</td> </tr> <tr> <td style="text-align: center;"><b>490015005</b> H2027</td> <td style="text-align: center;"><b>490015015</b> H5060</td> </tr> </table>	<b>490015018</b> H1034A H1534A	<b>490015008</b> H5048 H5055	<b>490015019</b> H2034	<b>490015012</b> H2060	<b>490015021</b> H1060A H1560A	H2560 H3060 H4060	<b>490015005</b> H2027	<b>490015015</b> H5060
<b>490015018</b> H1034A H1534A	<b>490015008</b> H5048 H5055											
<b>490015019</b> H2034	<b>490015012</b> H2060											
<b>490015021</b> H1060A H1560A	H2560 H3060 H4060											
<b>490015005</b> H2027	<b>490015015</b> H5060											
LIMIT	FAN DELAY	CAPACITOR										
												
<b>410029000</b> ALL MODELS	<b>410126000</b> ALL MODELS	<b>1432-0002-003</b> ALL MODELS										

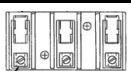

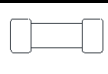



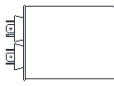



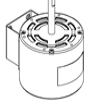
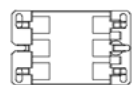
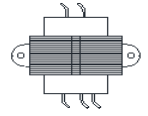

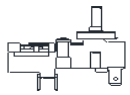
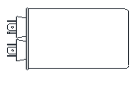
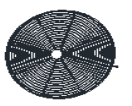
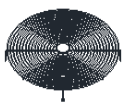

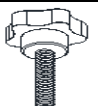
**HUHAA SERIES**

ELEMENT				MOTOR		
<b>QUANTITY OF ELEMENTS</b> 3 THRU 10KW (3) 15 THRU 30KW (6) 40 & 50KW (9)						
						
<b>1802-0087-024</b> HUHAA320	<b>1802-0087-031</b> HUHAA720 HUHAA1024	<b>1802-0087-037</b> HUHAA1520 HUHAA2024	<b>1802-0087-018</b> HUHAA3024	<b>3900-2002-506</b> HUHAA320 HUHAA324 HUHAA520 HUHAA524	<b>3900-0347-005</b> HUHAA748 HUHAA1048	<b>3900-0363-500</b> HUHAA2548 HUHAA3048
<b>1802-0087-000</b> HUHAA324	<b>1802-0087-006</b> HUHAA724	<b>1802-0087-012</b> HUHAA1524	<b>1802-0087-019</b> HUHAA3048 HUHAA3048A	<b>3900-0361-500</b> HUHAA1520 HUHAA1524	<b>3900-0361-501</b> HUHAA1548	<b>3900-2065-000</b> HUHAA2548A HUHAA3048A
<b>1802-0087-001</b> HUHAA327	<b>1802-0087-007</b> HUHAA727	<b>1802-0087-008</b> HUHAA1548	<b>1802-0087-020</b> HUHAA4024	<b>3900-2002-507</b> HUHAA327 HUHAA527	<b>3900-0362-002</b> HUHAA2020	<b>3900-0350-002</b> HUHAA5020
<b>1802-0087-002</b> HUHAA348	<b>1802-0087-008</b> HUHAA727	<b>1802-0087-026</b> HUHAA2020	<b>1802-0087-021</b> HUHAA4048	<b>3900-2005-000</b> HUHAA348 HUHAA548	<b>3900-0362-000</b> HUHAA2024	<b>3900-0350-000</b> HUHAA4024 HUHAA5024
<b>1802-0087-034</b> HUHAA520	<b>1802-0087-036</b> HUHAA1020	<b>1802-0087-016</b> HUHAA2524	<b>1802-0087-030</b> HUHAA5020	<b>3900-2014-004</b> HUHAA720 HUHAA724	<b>3900-0362-001</b> HUHAA2048	<b>3900-0350-001</b> HUHAA4048 HUHAA5048
<b>1802-0087-035</b> HUHAA524	<b>1802-0087-010</b> HUHAA1027	<b>1802-0087-017</b> HUHAA2548 HUHAA2548A	<b>1802-0087-022</b> HUHAA5024	HUHAA727 HUHAA1020 HUHAA1024 HUHAA1027	<b>3900-0364-000</b> HUHAA2524 HUHAA3020 HUHAA3024	
<b>1802-0087-004</b> HUHAA527	<b>1802-0087-011</b> HUHAA1048 HUHAA2048	<b>1802-0087-028</b> HUHAA3020	<b>1802-0087-023</b> HUHAA5048			
<b>1802-0087-005</b> HUHAA548						
FAN BLADE				PROTECTOR LIMIT		FAN DELAY
						
<b>1210-2000-000</b> HUHAA320 HUHAA324 HUHAA327 HUHAA348 HUHAA520 HUHAA524 HUHAA527 HUHAA548	<b>1210-0090-000</b> HUHAA720 HUHAA724 HUHAA727 HUHAA748 HUHAA1020 HUHAA1024 HUHAA1027 HUHAA1048	<b>1210-0098-000</b> HUHAA2524 HUHAA2548 HUHAA2548A HUHAA3020 HUHAA3024 HUHAA3048 HUHAA3048A	<b>4520-0011-000</b> HUHAA320 HUHAA324 HUHAA327 HUHAA348 HUHAA520 HUHAA524 HUHAA527 HUHAA548	<b>4520-0011-001</b> HUHAA720 HUHAA724 HUHAA727 HUHAA748 HUHAA1020 HUHAA1024 HUHAA1027 HUHAA1048 HUHAA1520 HUHAA1524 HUHAA1548 HUHAA2020 HUHAA2024 HUHAA2048	<b>4520-0011-002</b> HUHAA2524 HUHAA2548 HUHAA2548A HUHAA3020 HUHAA3024 HUHAA3048 HUHAA3048A HUHAA4024 HUHAA4048 HUHAA5020 HUHAA5024 HUHAA5048	<b>4520-0010-000</b> ALL MODELS
	<b>1210-0090-001</b> HUHAA1520 HUHAA1524 HUHAA1548	<b>1210-11004-000</b> HUHAA4024 HUHAA4048 HUHAA5020 HUHAA5024 HUHAA5048				
	<b>1210-0096-000</b> HUHAA2020 HUHAA2024 HUHAA2048					
RELAY				POWER TR		
						
<b>5018-0003-000</b> HUHAA720 HUHAA724 HUHAA727 HUHAA1024 HUHAA1027	<b>5018-0004-100</b> HUHAA348 HUHAA548 HUHAA748 HUHAA1020 HUHAA1048 HUHAA1548 HUHAA2048 HUHAA4048 HUHAA5048	<b>5018-0005-004</b> HUHAA1520 HUHAA1524 HUHAA2020 HUHAA2524 HUHAA2548 HUHAA3024 HUHAA3048 HUHAA3048A HUHAA4024 HUHAA4048 HUHAA5024	<b>5018-0006-000</b> HUHAA2024 HUHAA3020 HUHAA5020 HUHAA5048	<b>5814-0003-000</b> HUHAA720 HUHAA724 HUHAA1020 HUHAA1024 HUHAA1520 HUHAA1524 HUHAA2020 HUHAA2024 HUHAA2524 HUHAA3020 HUHAA3024	<b>5814-0003-002</b> HUHAA720 HUHAA724 HUHAA1048 HUHAA1548 HUHAA2048 HUHAA2548 HUHAA2548A HUHAA3048 HUHAA3048A HUHAA4048 HUHAA5048	<b>490026007</b> HUHAA4024 HUHAA5020 HUHAA5024
				<b>5814-0003-001</b> HUHAA727 HUHAA1027		

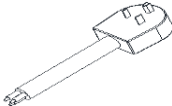
**HUHAA CONTINUED**

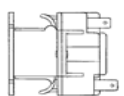

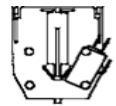
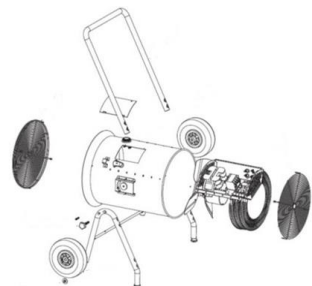
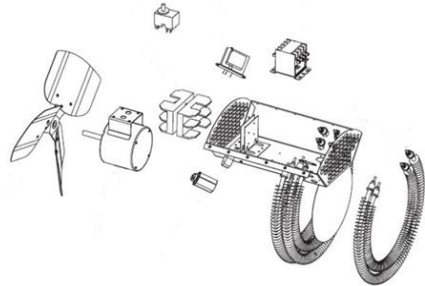

CONTROL BOARD			POWER BLOCK		FUSE BLOCK	FUSE	
							
<b>5823-0001-000</b> HUHAA320 HUHAA324 HUHAA327 HUHAA520 HUHAA524 HUHAA527	<b>5823-0002-000</b> HUHAA348 HUHAA548 HUHAA724 HUHAA727 HUHAA748 HUHAA1020 HUHAA1024 HUHAA1027 HUHAA1048 HUHAA1520 HUHAA1548		<b>5823-0004-000</b> HUHAA320 HUHAA324 HUHAA327 HUHAA348 HUHAA520 HUHAA524 HUHAA527 HUHAA548 HUHAA720		<b>5823-0004-001</b> HUHAA1524 HUHAA2548 HUHAA2548A HUHAA3048 HUHAA3048A  <b>5823-0004-002</b> HUHAA2020 HUHAA2024 HUHAA2524 HUHAA4048 HUHAA5048  <b>5823-0004-003</b> HUHAA1520 HUHAA3024  <b>5823-0005-000</b> HUHAA3020 HUHAA4024 HUHAA5020 HUHAA5024	<b>2025-0002-000</b> HUHAA1520 HUHAA2020  <b>480030004</b> HUHAA2524 HUHAA3020 HUHAA3024 HUHAA4024 HUHAA5020 HUHAA5024  <b>2025-0001-000</b> HUHAA5048  <b>2025-7004-000</b> HUHAA5048	<b>2019-0007-010</b> HUHAA1520  <b>2019-0007-008</b> HUHAA2020  <b>2019-7008-077</b> HUHAA2524  <b>2019-7008-080</b> HUHAA3020 HUHAA5020  <b>2019-7008-079</b> HUHAA3024 HUHAA5024  <b>2019-7008-078</b> HUHAA4024  <b>2019-7002-008</b> HUHAA5048  <b>2019-7002-012</b> HUHAA5048
<b>LOUVERS</b>			<b>LOUVER SPRING</b>	<b>HI/LOW SW.</b>	<b>CAPACITOR</b>		
<b>QUANTITY</b> 3&5KW (5) 7 THRU 20KW (6) 25 THRU 50KW (9)							
<b>3503-2004-106</b> HUHAA320 HUHAA324 HUHAA327 HUHAA348 HUHAA520 HUHAA524 HUHAA527 HUHAA548	<b>3503-2004-101</b> HUHAA720 HUHAA724 HUHAA727 HUHAA748 HUHAA1020 HUHAA1024 HUHAA1027 HUHAA1048 HUHAA1520 HUHAA1548 HUHAA2020 HUHAA2024 HUHAA2048	<b>3503-2004-108</b> HUHAA2524 HUHAA2548 HUHAA2548A HUHAA3020 HUHAA3024 HUHAA3048 HUHAA3048A HUHAA4024 HUHAA4048 HUHAA5020 HUHAA5024 HUHAA5048	<b>5208-7005-001</b> ALL MODELS	<b>5216-2053-000</b> HUHAA2524 HUHAA2548 HUHAA2548A HUHAA3020 HUHAA3024 HUHAA3048 HUHAA3048A HUHAA4024 HUHAA4048 HUHAA5020 HUHAA5024 HUHAA5048	<b>1432-0002-003</b> HUHAA2020 HUHAA2024 HUHAA2048 HUHAA2524 HUHAA2548  <b>1432-0002-001</b> HUHAA3020 HUHAA2548A HUHAA3048A  <b>1432-0002-004</b> HUHAA4024 HUHAA4048 HUHAA5020 HUHAA5024 HUHAA5048		

## BDH SERIES

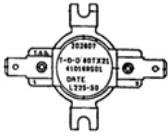
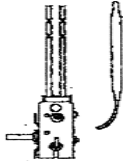
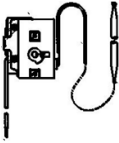
ELEMENT SMALL		ELEMENT LARGE		MOTOR		CONTACTOR		TRANSFORMER			
											
<b>1802-11001-000</b> DH1583A DH1583B DH1583C		<b>1802-11001-001</b> DH1583A DH1583B DH1583C		<b>3900-11002-000</b> DH1021A DH1021CKA DH1021CKB DH1021CKC DH1521A DH1521B DH1521C DH1523A DH1523B DH1523C DH1543A DH1543B DH1543C DH3043A DH3043B DH3043C		<b>5018-0006-000</b> DH1543A DH1543B DH1543C DH3043A DH3043B DH3043C		<b>5018-0006-004</b> DH1021A DH1021CKA DH1021CKB DH1521A DH1521B DH1521C DH1523A DH1523B DH1523C DH1583A DH1583B DH1583C		<b>5814-0003-002</b> DH1543A DH1543B DH1543C DH3043A DH3043B DH3043C	
<b>1802-11001-002</b> DH1021A DH1021CKA DH1021CKB DH1021CKC DH1521A DH1521B DH1521C DH1523A DH1523B DH1523C DH1543A DH1543B DH1543C DH3043A DH3043B DH3043C		<b>1802-11001-003</b> DH1021A DH1021CKA DH1021CKB DH1021CKC DH1521A DH1521B DH1521C DH1523A DH1523B DH1523C DH1543A DH1543B DH1543C DH3043A DH3043B DH3043C		<b>3900-11002-001</b> DH1543A DH1543B DH1543C DH3043A DH3043B DH3043C		<b>5018-0006-002</b> DH1021CKC					
FAN BLADE		HI LIMIT		THERMOSTAT		CAPACITOR		GUARD REAR		GUARD FRONT	
											
<b>1210-0098-001</b> ALL MODELS		<b>410029000</b> ALL MODELS		<b>5813-2059-000</b> ALL MODELS		<b>1432-0002-003</b> ALL MODELS		<b>2504-11004-000</b> ALL MODELS		<b>2504-11005-000</b> ALL MODELS	
HANDLE		CART KNOB		THERMOSTAT KNOB		WHEEL		SHAFT CAP		AXEL SHAFT	
											
<b>2710-11001-000</b> ALL MODELS		<b>3301-11003-000</b> ALL MODELS		<b>3301-11018-002</b> ALL MODELS		<b>6406-11001-000</b> ALL MODELS		<b>1408-11002-000</b> ALL MODELS		<b>5217-11001-000</b> ALL MODELS	
CORD		FUSE		FUSE BLOCK		FAN RELAY		FAN DELAY		AUXILIARY SWITCH	
											
<b>1016-10593-000</b> DH1021CKA DH1021CKB <b>SCS10063</b> DH1021CKC		<b>2019-7008-077</b> DH1521A DH1521B DH1521C		<b>480030007</b> DH1521A DH1521B DH1521C		<b>5018-0007-000</b> DH1543A DH1543B DH1543C DH3043A DH3043B DH3043C		<b>1414-2039-000</b> DH3043C		<b>5216-10564-000</b> DH1521C DH1543A DH1543B DH1543C DH3043A DH3043B DH3043C	
											

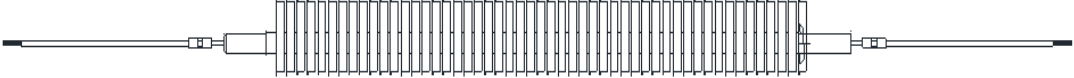

CC & DCC		
SPOT LIMIT	THERMOSTAT 1-POLE	THERMOSTAT 2-POLE
		
410027000 ALL MODELS	410112000 ALL MODELS	410113000 ALL MODELS

DB SERIES				
				
DISCRIPTION	PART NUMBERS			
	120V	208V	240V	277V
<b>*ELEMENT (100 WATTS/FT)</b>				
38"	1802-2016-014	1802-2016-006	1802-2016-007	1802-2016-015
50"	1802-2016-016	1802-2016-017	1802-2016-018	1802-2016-019
62"	1802-2016-026	1802-2016-027	1802-2016-028	1802-2016-029
<b>*ELEMENT (188 WATTS/FT)</b>				
38"	1802-2016-012	1802-2016-010	1802-2016-011	1802-2016-013
50"	1802-2016-020	1802-2016-024	1802-2016-025	1802-2016-021
62"	1802-2016-030	1802-2016-034	1802-2016-035	1802-2016-031
				
<b>LINEAR LIMIT</b>		<b>TERMINAL BOX COVER</b>	<b>ELEMENT HANGER CLIP</b>	
38"	410122003	<del>310527001</del>	402020000	
50"	410122004			
62"	410122005			

## WRL SERIES (OBSOLETE)

### ELEMENT

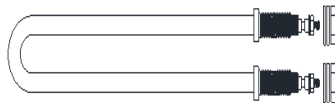
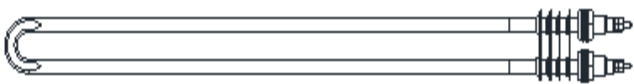

**1802-7076-001**

L1511B

**1802-7076-008**

L4521B

**HE45240**

L4521

**1802-7076-003**

L2021B

**1802-7076-010**

L4541B

**HE45480**

L4541

**1802-7076-005**

L2041B

**1802-7076-011**

L4561B

**HE20240**

L6023

**1802-7076-006**

L2061B

**1802-7076-009**

L4571B

**HE20480**

L6043

**1802-7076-004**

L2071B

**1802-7076-007**

L4581B

**HE45480**

L13543

**1802-7076-002**

L2081B

### RELECTOR

**891755004**

L1511B

**891755002**

L4581B

L4541B

L4521B



**1.5KW Portable**



**4.5KW Portable**

## YRN SERIES (OBSOLETE)

### ELEMENT





<b>1802-2115-001</b> N1011A	<b>1802-2115-013</b> N2001A	<b>1802-7077-001</b> N1011B	<b>1802-7077-009</b> N2001B
<b>1802-2115-004</b> N1021A	<b>1802-2115-015</b> N2021A	<b>1802-7077-003</b> N1021B	<b>1802-7077-010</b> N2021B
<b>1802-2115-006</b> N1031A	<b>1802-2115-017</b> N2031A	<b>1802-7077-002</b> N1081B	<b>1802-7077-012</b> N2031B
<b>1802-2115-005</b> N1071A	<b>1802-2115-016</b> N2071A	<b>1802-7077-004</b> N1511B	<b>1802-7077-011</b> N2071B
<b>1802-2115-008</b> N1501A	<b>1802-2115-018</b> N2501A	<b>1802-7077-006</b> N1521B	<b>1802-7077-013</b> N2501B
<b>1802-2115-007</b> N1511A	<b>1802-2115-020</b> N2521A	<b>1802-7077-008</b> N1531B	<b>1802-7077-014</b> N2521B
<b>1802-2115-010</b> N1521A	<b>1802-2115-022</b> N2531A	<b>1802-7077-007</b> N1571B	<b>1802-7077-016</b> N2531B
<b>1802-2115-012</b> N1531A	<b>1802-2115-021</b> N2571A	<b>1802-7077-005</b> N1581B	<b>1802-7077-015</b> N2571B
<b>1802-2115-011</b> N1571A			





**FRR & PMRR SERIES (OBSOLETE)**

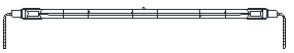

**ELEMENT**

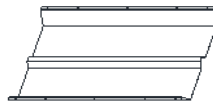
			
1802-0070-509 RR22012A	1802-2113-501 RR41512A	1802-2119-500 RR10512A	1802-2151-001 RR26164
1802-0070-550 RR35724A	1802-2113-516 RR53024A	RR11012A	1802-2151-000 RR26168

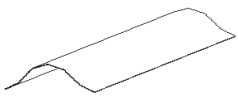
**REFLECTOR**



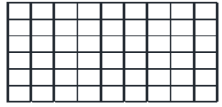
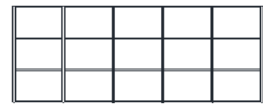

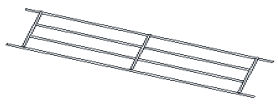
			
5007-2013-000 RR41512A	5007-2020-000 RR22012A	5007-2021-000 RR10512A	5007-2027-000 RR26164
5007-2013-001 RR53024A	5007-2020-001 RR35724A	RR11012A	RR26168

**WIRE GUARD**

			
2504-2014-000 RR35724A	2504-2015-000 RR22012A	2504-2016-000 RR41512A	2504-2017-000 RR10512A
		2504-2016-001 RR53024A	RR11012A
		2504-2016-002 RR26164	
		RR26168	

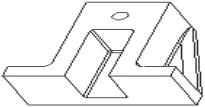
**CERAMIC BLOCK**

**SWITCH**





			
1224-0049-000 RR22012A	1224-2006-000 RR10512A	410024000 RR11012A	5216-11009-000 RR22012A
RR26164	RR11012A		RR35724A
RR26168			
RR35724A			

**ELEMENT BUSHING**

**CORD**

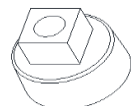
**CHAIN 4'**

**"S" HOOKS**

			
1213-0070-000 RR22012A	1420-2016-000 RR10512A	1404-2000-001 RR10512A	2706-2000-000 RR10512A
RR26164	RR41512A	RR11012A	RR11012A
RR26168	1420-2016-008 RR11012A	RR22012A	RR22012A
RR35724A	1420-2016-002 RR22012A	RR35724A	RR35724A
	1420-2031-000 RR35724A	RR41512A	RR41512A
	1420-2016-001 RR53024A	RR53024A	RR53024A

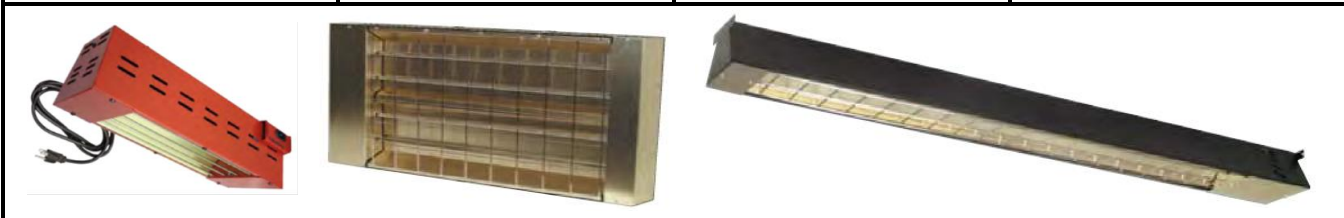

## RH SERIES

KEY NUMBER	DESCRIPTION	PART NUMBER		
		RH__26	RH__35	RH__48
1	REFLECTOR: 60/90 SYM	-	-	-
	30 DEGREES SYM	-	-	-
	60/90 ASYM	-	-	-
	30 DEGREES ASYM	-	-	-
2	INSULATOR	-	-	-
3	TERMINAL BLOCK (4 REQ)	1224-0049-000	1224-0049-000	1224-0049-000
4	ELEMENT TERM. BUSH. (4 REQ)	1213-0070-000	1213-0070-000	1213-0070-000
<b>ELEMENTS</b>				
-	RH16-91S-208	2QL16208		
	RH16-91S-240	2QL16240		
	RH16-91S-277	2QL16277		

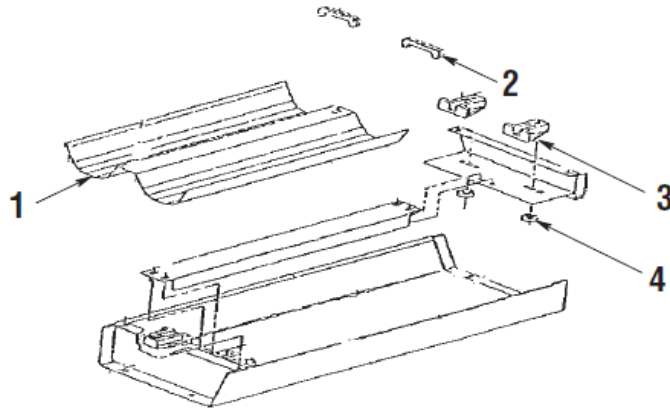

**INDUSTRIAL CEILING FANS (FANS ARE PHASED OUT SOME PARTS MAY NOT BE AVAILABLE)**

**BLADE (SET)**

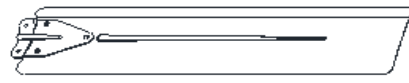

<b>9B3620-1</b> 36201	<b>9B4820-3</b> 48203	<b>9B5600-1</b> 56001	<b>9B6000-1</b> 60001	<b>9B5630-1R</b> 56301RDP
<b>9B4820-1</b> 48201 48207	<b>9B5600-1LC</b> 56001LC 56101	56002 56003 56007	<b>9B6001-1</b> 60011 <b>9B6011-1</b> 60101 60111	
<b>9B4820-1B</b> 48201B	56111	<b>9B5601-1</b> 56011	<b>9B5620-1</b> 56201	
		<b>9B5600-1B</b> 56001B		

**DOWNROD 24"**

**DOWNROD 8"**

**MOTOR**



<b>9D24BW</b> 36201 48201 56001LC 56001 56002 56003 56007 56301RDP 48203 48207 60001 56201	<b>9D248BLK</b> 48201B 56001B <b>9D24BB</b> 56011 60011 <b>9D12TW</b> 56101 56111 60101 60111	<b>9D08</b> 36201 48201 56001LC 56003 48203 <b>9D08BBLK</b> 48201B	<b>9M3620-1-A</b> 36201 <b>9M4820-1-A</b> 48201 <b>9M4820-1B-A</b> 48201B <b>9M4820-3-A</b> 48203 <b>9M5600-7-A</b> 48207 <b>6011-1U</b> 60101 60111	<b>9M5600-1LC-A</b> 56001LC <b>9M5600-1-A</b> 56001 <b>9M5600-1B-A</b> 56001B <b>9M5600-4-A</b> 56002 <b>9M5600-3-A</b> 56003 <b>9M5600-7-A</b> 56007	<b>9M5601-1-A</b> 56011 <b>5611-1U</b> 56101 56111 <b>9M5630-1R-A</b> 56301RDP <b>9M6000-1-A</b> 60001 <b>9M6001-1-A</b> 60011 <b>9M5620-1-A</b> 56201
--	---	---	--	--	--

**RUBBER ROLLER**

**J HOOK KIT**

**BLADE SCREWS (6 REQ)**

**BLADE PADS (3 REQ)**

**REVERSIBLE TOGGLE**

**REVERSING SW. PLATE**

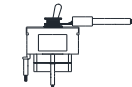
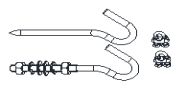
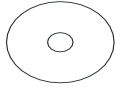

<b>9F2900-04A</b> ALL MODELS	<b>9F2900-01</b> ALL MODELS	<b>9F2900-20A</b> ALL MODELS	<b>9F2900-19A</b> ALL MODELS	<b>9F2GX54-73</b> 56301RDP	<b>9FP005</b> 56301RDP
---------------------------------	--------------------------------	---------------------------------	---------------------------------	-------------------------------	---------------------------

**CANOPY UPPER**

**CANOPY LOWER**



<b>9F2900-07A</b> 36201 48201 56001LC 56001 56002 56003 56007 56301RDP 48203 48207 60001 56201	<b>9F2900-07AB</b> 48201B 56001B <b>9FP029</b> 56011 60011 <b>3100039A</b> 56101 56111 60101 60111	<b>9F2900-08A</b> 36201 48201 56001LC 56001 56002 56003 56007	60001 60101 60111 56301RDP 48203 48207 56101 56111	<b>9F2900-08AB</b> 48201B 56001B <b>9FP030</b> 56011 60011
--	--	--	---	---

**3-SPEED PULL CHAIN SW.**

**PULL CHAIN STRING**

**OUTDOOR KIT**

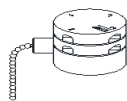

PICTURE NOT AVAILABLE

<b>9F2900-26</b> 48203 56003	<b>3378</b> 48203 56003	99992 56101 60101
------------------------------------	-------------------------------	-------------------------

