

THERMAZONE SERIES

Infrared Heaters for Industrial/Commercial/Residential



Technical Specifications:

Element Types: Flat Panel Emitter

Reflection Angles: 60 degrees

Mounting Types:

- › Ceiling Mount
- › Wall Mount
- › Hung by chain or threaded rod

Ideal Spaces:

Warehouses
 Factories
 Manufacturing Plants
 Storage Facilities
 Workshops and Garages
 Autobody and Repair Shops
 Fitness Studios
 Hot Yoga
 Restaurants
 Patios
 Docks
 Walkways / Entryways



Black

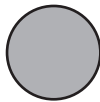

Stainless Steel

PERFORMANCE

- › **ENGINEERED FOR USING LOWER WAVELENGTHS** - to radiate heat, Thermazone heaters generate long wavelength heat, which are the most consistent, even, and energy efficient in the industry.
- › **SPEC VERSATILITY** - Quiet, versatile mounting and complimenting with controls.

EASE OF MAINTENANCE

- › **NO MOVING PARTS** - Nothing to break or wear out means the Thermazone is maintenance free.
- › **NO REFLECTORS TO CLEAN** - No bulbs means no need for reflectors. Another reason Thermazone heaters require zero maintenance.
- › **NO BULBS** - Save yourself money and frustration by never having to replace a bulb.
- › **MOUNTING** - Wall and ceiling mounting bracket is included with each heater. Heater is also able to be hung by chain or threaded rod.

PREMIUM COMFORT

- › **ZERO GLOW** - Thermazone unit is designed with a clean, black facade, emitting zero light and blending into the space.
- › **SILENT** - No fans or moving parts to create noise and no buzz or hum from intense bulbs means Thermazone is completely silent.



THERMAZONE SERIES

Infrared Heaters for Industrial/Commercial/Residential



QMARK THERMAZONE SERIES		SINGLE PHASE AMPERAGES										
MODEL 1X	WATTAGE	120V	208V	240V	277V	347V	480V	600V				
QR-ST5-U12-0871B	871	7.3	-	-	-	-	-	-				
QR-ST5-U12-1081B	1081	9.0	-	-	-	-	-	-				
QR-ST5-U12-1111B	1111	9.3	-	-	-	-	-	-				
QR-ST5-U12-1681B	1681	14.0	-	-	-	-	-	-				
QR-ST5-U12-1436V	1077/1436	-	5.2	6.0	-	-	-	-				
MODEL 2X	WATTAGE	SINGLE PHASE AMPERAGES							THREE PHASE AMPERAGES			
		120V	208V	240V	277V	347V	480V	600V	208V	240V	480V	600V
QR-ST5-U24-1015V	1015	-	-	4.3	-	-	-	-	-	-	-	-
QR-ST5-U24-1316B	1316	11.0	-	-	-	-	-	-	-	-	-	-
QR-ST5-U24-1297V	1297	-	-	5.4	-	-	-	-	-	-	-	-
QR-ST5-U24-1659B	1659	13.8	-	-	-	-	-	-	-	-	-	-
QR-ST5-U24-1701V	1276/1701	-	6.1	7.1	-	-	-	-	-	-	-	-
QR-ST5-U24-2192B	2192	18.3	-	-	-	-	-	-	-	-	-	-
QR-ST5-U24-2001V	1501/2001	-	7.2	8.3	-	-	-	-	-	-	-	-
QR-ST5-U24-1982N	1982	-	-	-	7.2	-	-	-	-	-	-	-
QR-ST5-U24-2060I	2060	-	-	-	-	6.0	-	-	-	-	-	-
QR-ST5-U24-2222B	2222	18.5	-	-	-	-	-	-	-	-	-	-
QR-ST5-U24-2428V	1821/2428	-	8.8	10.2	-	-	-	-	-	-	-	-
QR-ST5-U24-2388N	2388	-	-	-	8.6	-	-	-	-	-	-	-
QR-ST5-U24-2488I	2488	-	-	-	-	7.2	-	-	-	-	-	-
QR-ST5-U24-3363B	3363	28.0	-	-	-	-	-	-	-	-	-	-
QR-ST5-U24-3239V	2429/3239	-	11.7	13.5	-	-	-	-	-	-	-	-
QR-ST5-U24-3008N	3008	-	-	-	10.1	-	-	-	-	-	-	-
QR-ST5-U24-3176I	3176	-	-	-	-	9.2	-	-	-	-	-	-
QR-ST5-U24-1992P	1496/1992	-	-	-	-	-	-	-	4.2	4.8	-	-
QR-ST5-U24-2442P	1834/2442	-	-	-	-	-	-	-	5.1	5.9	-	-
QR-ST5-U24-3021P	2284/3041	-	-	-	-	-	-	-	6.4	7.3	-	-
MODEL 4X	WATTAGE	SINGLE PHASE AMPERAGES							THREE PHASE AMPERAGES			
		120V	208V	240V	277V	347V	480V	600V	208V	240V	480V	600V
QR-ST5-U48-2030V	1523/2030	-	7.3	8.5	-	-	-	-	-	-	-	-
QR-ST5-U48-2014I	2014	-	-	-	-	5.8	-	-	-	-	-	-
QR-ST5-U48-2030T	2030	-	-	-	-	-	4.2	-	-	-	-	-
QR-ST5-U48-2594V	1946/2594	-	9.4	10.8	-	-	-	-	-	-	-	-
QR-ST5-U48-2502I	2502	-	-	-	-	7.2	-	-	-	-	-	-
QR-ST5-U48-2594T	2594	-	-	-	-	-	5.4	-	-	-	-	-
QR-ST5-U48-3402V	2552/3402	-	12.3	14.2	-	-	-	-	-	-	-	-
QR-ST5-U48-3206I	3206	-	-	-	-	9.3	-	-	-	-	-	-
QR-ST5-U48-3402T	3402	-	-	-	-	-	7.1	-	-	-	-	-
QR-ST5-U48-4002V	3002/4002	-	14.5	16.7	-	-	-	-	-	-	-	-
QR-ST5-U48-3964N	3964	-	-	-	14.3	-	-	-	-	-	-	-
QR-ST5-U48-4120I	4120	-	-	-	-	11.9	-	-	-	-	-	-
QR-ST5-U48-4002T	4002	-	-	-	-	-	8.3	-	-	-	-	-
QR-ST5-U48-4042Y	4042	-	-	-	-	-	-	6.7	-	-	-	-
QR-ST5-U48-4856V	3642/4856	-	17.5	20.2	-	-	-	-	-	-	-	-
QR-ST5-U48-4776N	4776	-	-	-	17.2	-	-	-	-	-	-	-
QR-ST5-U48-4976I	4976	-	-	-	-	14.4	-	-	-	-	-	-
QR-ST5-U48-4856T	4856	-	-	-	-	-	10.1	-	-	-	-	-
QR-ST5-U48-4878Y	4878	-	-	-	-	-	-	8.1	-	-	-	-
QR-ST5-U48-6478V	4859/6478	-	23.4	27.0	-	-	-	-	-	-	-	-
QR-ST5-U48-6056N	6056	-	-	-	21.7	-	-	-	-	-	-	-
QR-ST5-U48-6352I	6352	-	-	-	-	18.3	-	-	-	-	-	-
QR-ST5-U48-6478T	6478	-	-	-	-	-	13.5	-	-	-	-	-
QR-ST5-U48-6118Y	6118	-	-	-	-	-	-	10.2	-	-	-	-
QR-ST5-U48-3971P	2983/3971	-	-	-	-	-	-	-	8.3	9.6	-	-
QR-ST5-U48-3928U	3928	-	-	-	-	-	-	-	-	-	4.7	-
QR-ST5-U48-3963Z	3963	-	-	-	-	-	-	-	-	-	-	3.8
QR-ST5-U48-4794P	3601/4794	-	-	-	-	-	-	-	10.0	11.6	-	-
QR-ST5-U48-4838U	4838	-	-	-	-	-	-	-	-	-	5.8	-
QR-ST5-U48-4797Z	4797	-	-	-	-	-	-	-	-	-	-	4.6
QR-ST5-U48-5954P	4472/5954	-	-	-	-	-	-	-	12.4	14.3	-	-
QR-ST5-U48-6060U	6060	-	-	-	-	-	-	-	-	-	7.3	-
QR-ST5-U48-5982Z	5982	-	-	-	-	-	-	-	-	-	-	5.8

THERMAZONE SERIES

Infrared Heaters for Industrial/Commercial/Residential

QMARK THERMAZONE THIN SERIES		SINGLE PHASE AMPERAGES		
18" Model	WATTAGE	120V	208V	240V
QR-STT-U18-1091B	1091	9.1	-	-
QR-STT-U18-1330B	1330	11.5	-	-
QR-STT-U18-1767B	1767	14.8	-	-
QR-STT-U18-2161B	2161	18.1	-	-
36" MODEL				
QR-STT-U36-2180V	2180/1635	-	6.8	9.1
QR-STT-U36-2660V	2660/2071	-	8.6	11.5
QR-STT-U36-3104V	3104/2328	-	9.7	12.9
QR-STT-U36-3534V	3534/2661	-	11.1	14.8
QR-STT-U36-4322V	4322/3242	-	15.6	18.1

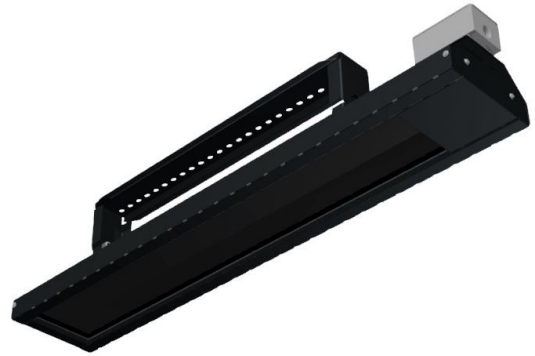

Optional Accessories: Thermazone

CATALOG NO.	DESCRIPTION	COMPATIBLE WITH
03-104	12" x 24" SS Grid	All 12" x 24" Heaters All 1P 12" x 48" Heaters*
03-105	12" x 12" SS Grid	All 12" x 12" Heaters
03-106	12" x 16" SS Grid	All 3P 12" x 48" Heaters**

NOTES:
* requires qty 2
** requires qty 3

Optional Local Controls:

MODEL #	DESCRIPTION	SUPPLY VOLTAGE	PHASE	AMP RATING	SUITABLE WITH		
					CONTACTOR PANEL	STAND ALONE	SSR PANEL
TZ-REM-PT	Fixed Cycle Controller w/ Adjustable Output	120/24	1	NA	-	-	✓
TZ-PCT	Adjustable Cycle Controller w/ Adjustable Output	120/240	1	28	✓	✓	✓
TZ-TIMER	0-60 Min Heavy Duty In-Wall On/Off Timer	120/240	1	28	✓	✓	✓
TZ-TIMER2HR	0-120 Min Heavy Duty In-Wall On/Off Timer	120/240	1	20	✓	✓	✓
TZ-HUB	App Based Z-Wave Wireless Connection Hub	120	1	NA	✓	✓	✓
TZ-SWITCH	App Based Z-Wave Wireless Junction Box	120/240	1	40	✓	✓	✓

*Optional controls suitable for isolated control of your heater(s), or to be paired with QMarks line of control panels to operate banks of heaters together. Options range from adjustable output cycle timers with fixed and adjustable cycle times, to standard on/off timer control, and introducing market leading Z-Wave app based control for easy operation from your phone."

Clearances:

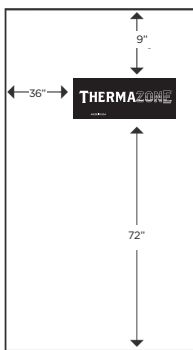

CLEARANCES	Between Heaters	36"	36"
	To Side Walls	Wall Mounted: 4" Ceiling Mounted Vertical: 36" Ceiling Mounted Angled Away: 4" Ceiling Mounted Angled Toward: 72"	Wall Mounted: 7" Ceiling Mounted Vertical: 36" Ceiling Mounted Angled Away: 7" Ceiling Mounted Angled Toward: 72"
To Ceiling	Wall Mounted: 4" Ceiling Mounted Vertical: 4" Ceiling Mounted Angled Away: 4" Ceiling Mounted Angled Toward: 4"	Wall Mounted: 7" Ceiling Mounted Vertical: 4" Ceiling Mounted Angled Away: 7" Ceiling Mounted Angled Toward: 4"	
To Floor	72"	72"	
To Overhang	18"	12"	

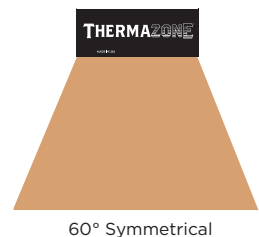
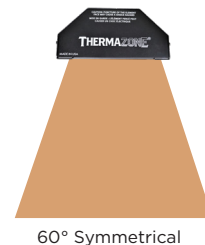

THERMAZONE SERIES

Infrared Heaters for Industrial/Commercial/Residential

Scan the QR code to access additional specs and features



Dimensions: 1' Thermazone Heater

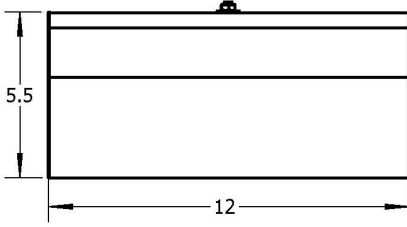

Dimensions: 2' Thermazone Heater

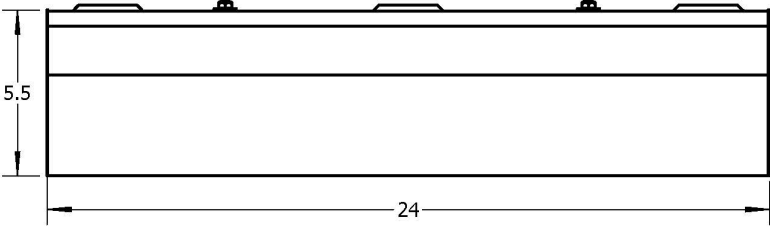

Dimensions: 4' Thermazone Heater

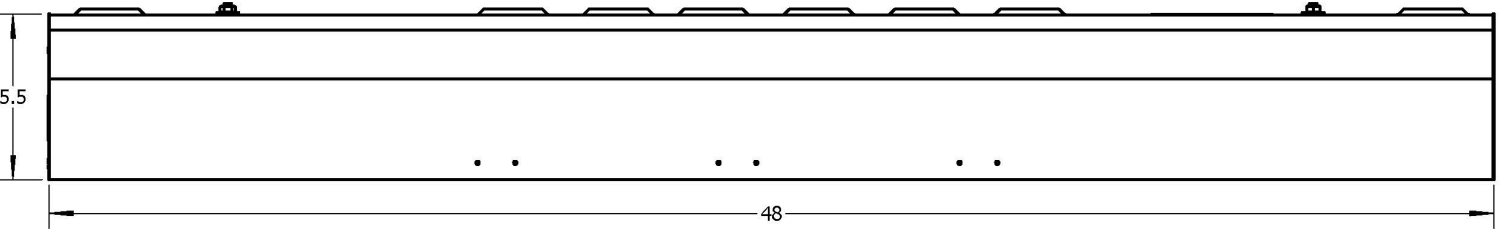

Dimensions: All Models - End View

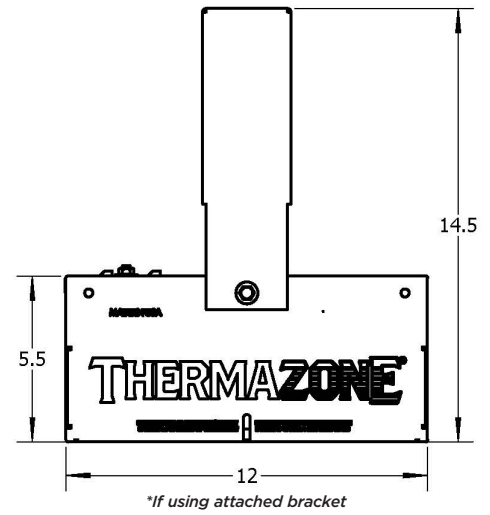

THERMAZONE THIN SERIES

Infrared Heaters for Industrial/Commercial/Residential

Dimensions: 18" Thermazone Thin Heater

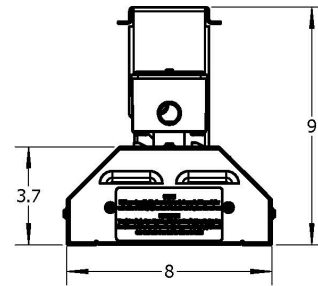
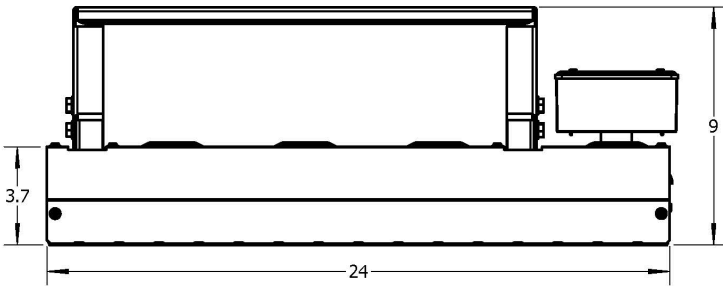

Dimensions: 36" Thermazone Thin Heater

