

THERMAZONE SERIES

Infrared Heaters for Industrial/Commercial/Residential



Technical Specifications:

Element Types: Flat Panel Emitter

Reflection Angles: 60 degrees

Mounting Types:

- › Ceiling Mount
- › Wall Mount
- › Hung by chain or threaded rod

Ideal Spaces:

Warehouses
Factories
Manufacturing Plants
Storage Facilities
Workshops and Garages
Autobody and Repair Shops
Fitness Studios
Hot Yoga
Restaurants
Patios
Docks
Walkways / Entryways



Black

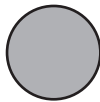

Stainless Steel

PERFORMANCE

- › **ENGINEERED FOR USING LOWER WAVELENGTHS** - to radiate heat, Thermazone heaters generate long wavelength heat, which are the most consistent, even, and energy efficient in the industry.
- › **SPEC VERSATILITY** - Quiet, versatile mounting and complimenting with controls.

EASE OF MAINTENANCE

- › **NO MOVING PARTS** - Nothing to break or wear out means the Thermazone is maintenance free.
- › **NO REFLECTORS TO CLEAN** - No bulbs means no need for reflectors. Another reason Thermazone heaters require zero maintenance.
- › **NO BULBS** - Save yourself money and frustration by never having to replace a bulb.
- › **MOUNTING** - Wall and ceiling mounting bracket is included with each heater. Heater is also able to be hung by chain or threaded rod.

PREMIUM COMFORT

- › **ZERO GLOW** - Thermazone unit is designed with a clean, black facade, emitting zero light and blending into the space.
- › **SILENT** - No fans or moving parts to create noise and no buzz or hum from intense bulbs means Thermazone is completely silent.



THERMAZONE SERIES

Infrared Heaters for Industrial/Commercial/Residential



| QMARK THERMAZONE SERIES | | SINGLE PHASE AMPERAGES | | | | | | | |
|-------------------------|-----------|------------------------|------|------|------|------|------|------|--|
| MODEL 1X | WATTAGE | 120V | 208V | 240V | 277V | 347V | 480V | 600V | |
| QR-ST5-U12-0871B | 871 | 7.3 | - | - | - | - | - | - | |
| QR-ST5-U12-1081B | 1081 | 9.0 | - | - | - | - | - | - | |
| QR-ST5-U12-1111B | 1111 | 9.3 | - | - | - | - | - | - | |
| QR-ST5-U12-1681B | 1681 | 14.0 | - | - | - | - | - | - | |
| QR-ST5-U12-1436V | 1077/1436 | - | 5.2 | 6.0 | - | - | - | - | |

| MODEL 2X | WATTAGE | SINGLE PHASE AMPERAGES | | | | | | | | THREE PHASE AMPERAGES | | | |
|------------------|-----------|------------------------|------|------|------|------|------|------|------|-----------------------|------|------|---|
| | | 120V | 208V | 240V | 277V | 347V | 480V | 600V | 208V | 240V | 480V | 600V | |
| QR-ST5-U24-1015V | 1015 | - | - | 4.3 | - | - | - | - | - | - | - | - | - |
| QR-ST5-U24-1316B | 1316 | 11.0 | - | - | - | - | - | - | - | - | - | - | - |
| QR-ST5-U24-1297V | 1297 | - | - | 5.4 | - | - | - | - | - | - | - | - | - |
| QR-ST5-U24-1659B | 1659 | 13.8 | - | - | - | - | - | - | - | - | - | - | - |
| QR-ST5-U24-1701V | 1276/1701 | - | 6.1 | 7.1 | - | - | - | - | - | - | - | - | - |
| QR-ST5-U24-2192B | 2192 | 18.3 | - | - | - | - | - | - | - | - | - | - | - |
| QR-ST5-U24-2001V | 1501/2001 | - | 7.2 | 8.3 | - | - | - | - | - | - | - | - | - |
| QR-ST5-U24-1982N | 1982 | - | - | - | 7.2 | - | - | - | - | - | - | - | - |
| QR-ST5-U24-2060I | 2060 | - | - | - | - | 6.0 | - | - | - | - | - | - | - |
| QR-ST5-U24-2222B | 2222 | 18.5 | - | - | - | - | - | - | - | - | - | - | - |
| QR-ST5-U24-2428V | 1821/2428 | - | 8.8 | 10.2 | - | - | - | - | - | - | - | - | - |
| QR-ST5-U24-2388N | 2388 | - | - | - | 8.6 | - | - | - | - | - | - | - | - |
| QR-ST5-U24-2488I | 2488 | - | - | - | - | 7.2 | - | - | - | - | - | - | - |
| QR-ST5-U24-3363B | 3363 | 28.0 | - | - | - | - | - | - | - | - | - | - | - |
| QR-ST5-U24-3239V | 2429/3239 | - | 11.7 | 13.5 | - | - | - | - | - | - | - | - | - |
| QR-ST5-U24-3008N | 3008 | - | - | - | 10.1 | - | - | - | - | - | - | - | - |
| QR-ST5-U24-3176I | 3176 | - | - | - | - | 9.2 | - | - | - | - | - | - | - |
| QR-ST5-U24-1992P | 1496/1992 | - | - | - | - | - | - | - | 4.2 | 4.8 | - | - | - |
| QR-ST5-U24-2442P | 1834/2442 | - | - | - | - | - | - | - | 5.1 | 5.9 | - | - | - |
| QR-ST5-U24-3021P | 2284/3041 | - | - | - | - | - | - | - | 6.4 | 7.3 | - | - | - |

| MODEL 4X | WATTAGE | SINGLE PHASE AMPERAGES | | | | | | | | THREE PHASE AMPERAGES | | | |
|------------------|-----------|------------------------|------|------|------|------|------|------|------|-----------------------|------|------|---|
| | | 120V | 208V | 240V | 277V | 347V | 480V | 600V | 208V | 240V | 480V | 600V | |
| QR-ST5-U48-2030V | 1523/2030 | - | 7.3 | 8.5 | - | - | - | - | - | - | - | - | - |
| QR-ST5-U48-2014I | 2014 | - | - | - | - | 5.8 | - | - | - | - | - | - | - |
| QR-ST5-U48-2030T | 2030 | - | - | - | - | - | 4.2 | - | - | - | - | - | - |
| QR-ST5-U48-2594V | 1946/2594 | - | 9.4 | 10.8 | - | - | - | - | - | - | - | - | - |
| QR-ST5-U48-2502I | 2502 | - | - | - | - | 7.2 | - | - | - | - | - | - | - |
| QR-ST5-U48-2594T | 2594 | - | - | - | - | - | 5.4 | - | - | - | - | - | - |
| QR-ST5-U48-3402V | 2552/3402 | - | 12.3 | 14.2 | - | - | - | - | - | - | - | - | - |
| QR-ST5-U48-3206I | 3206 | - | - | - | - | 9.3 | - | - | - | - | - | - | - |
| QR-ST5-U48-3402T | 3402 | - | - | - | - | - | 7.1 | - | - | - | - | - | - |
| QR-ST5-U48-4002V | 3002/4002 | - | 14.5 | 16.7 | - | - | - | - | - | - | - | - | - |
| QR-ST5-U48-3964N | 3964 | - | - | - | 14.3 | - | - | - | - | - | - | - | - |
| QR-ST5-U48-4120I | 4120 | - | - | - | - | 11.9 | - | - | - | - | - | - | - |
| QR-ST5-U48-4002T | 4002 | - | - | - | - | - | 8.3 | - | - | - | - | - | - |
| QR-ST5-U48-4042Y | 4042 | - | - | - | - | - | - | 6.7 | - | - | - | - | - |
| QR-ST5-U48-4856V | 3642/4856 | - | 17.5 | 20.2 | - | - | - | - | - | - | - | - | - |
| QR-ST5-U48-4776N | 4776 | - | - | - | 17.2 | - | - | - | - | - | - | - | - |
| QR-ST5-U48-4976I | 4976 | - | - | - | - | 14.4 | - | - | - | - | - | - | - |
| QR-ST5-U48-4856T | 4856 | - | - | - | - | - | 10.1 | - | - | - | - | - | - |
| QR-ST5-U48-4878Y | 4878 | - | - | - | - | - | - | 8.1 | - | - | - | - | - |
| QR-ST5-U48-6478V | 4859/6478 | - | 23.4 | 27.0 | - | - | - | - | - | - | - | - | - |
| QR-ST5-U48-6056N | 6056 | - | - | - | 21.7 | - | - | - | - | - | - | - | - |
| QR-ST5-U48-6352I | 6352 | - | - | - | - | 18.3 | - | - | - | - | - | - | - |
| QR-ST5-U48-6478T | 6478 | - | - | - | - | - | 13.5 | - | - | - | - | - | - |
| QR-ST5-U48-6118Y | 6118 | - | - | - | - | - | - | 10.2 | - | - | - | - | - |
| QR-ST5-U48-3971P | 2983/3971 | - | - | - | - | - | - | - | 8.3 | 9.6 | - | - | - |
| QR-ST5-U48-3928U | 3928 | - | - | - | - | - | - | - | - | - | 4.7 | - | - |
| QR-ST5-U48-3963Z | 3963 | - | - | - | - | - | - | - | - | - | - | 3.8 | - |
| QR-ST5-U48-4794P | 3601/4794 | - | - | - | - | - | - | - | 10.0 | 11.6 | - | - | - |
| QR-ST5-U48-4838U | 4838 | - | - | - | - | - | - | - | - | - | 5.8 | - | - |
| QR-ST5-U48-4797Z | 4797 | - | - | - | - | - | - | - | - | - | - | 4.6 | - |
| QR-ST5-U48-5954P | 4472/5954 | - | - | - | - | - | - | - | 12.4 | 14.3 | - | - | - |
| QR-ST5-U48-6060U | 6060 | - | - | - | - | - | - | - | - | - | 7.3 | - | - |
| QR-ST5-U48-5982Z | 5982 | - | - | - | - | - | - | - | - | - | - | 5.8 | - |

THERMAZONE SERIES

Infrared Heaters for Industrial/Commercial/Residential

| QMARK THERMAZONE THIN SERIES | | SINGLE PHASE AMPERAGES | | |
|------------------------------|-----------|------------------------|------|------|
| 18" Model | WATTAGE | 120V | 208V | 240V |
| QR-STT-U18-1091B | 1091 | 9.1 | - | - |
| QR-STT-U18-1330B | 1330 | 11.5 | - | - |
| QR-STT-U18-1767B | 1767 | 14.8 | - | - |
| QR-STT-U18-2161B | 2161 | 18.1 | - | - |
| 36" MODEL | | | | |
| QR-STT-U36-2180V | 2180/1635 | - | 6.8 | 9.1 |
| QR-STT-U36-2660V | 2660/2071 | - | 8.6 | 11.5 |
| QR-STT-U36-3104V | 3104/2328 | - | 9.7 | 12.9 |
| QR-STT-U36-3534V | 3534/2661 | - | 11.1 | 14.8 |
| QR-STT-U36-4322V | 4322/3242 | - | 15.6 | 18.1 |

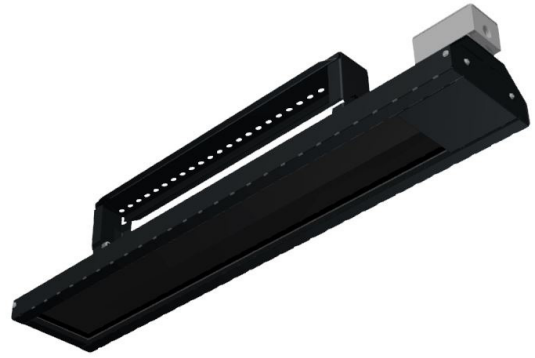

Optional Accessories: Thermazone

| CATALOG NO. | DESCRIPTION | COMPATIBLE WITH |
|-------------|-------------------|--|
| 03-104 | 12" x 24" SS Grid | All 12" x 24" Heaters All 1P 12" x 48" Heaters* |
| 03-105 | 12" x 12" SS Grid | All 12" x 12" Heaters |
| 03-106 | 12" x 16" SS Grid | All 3P 12" x 48" Heaters** |

NOTES:
* requires qty 2
** requires qty 3

Optional Local Controls:

| MODEL # | DESCRIPTION | SUPPLY VOLTAGE | PHASE | AMP RATING | SUITABLE WITH | | |
|-------------|--|----------------|-------|------------|-----------------|-------------|-----------|
| | | | | | CONTACTOR PANEL | STAND ALONE | SSR PANEL |
| TZ-REM-PT | Fixed Cycle Controller w/ Adjustable Output | 120/24 | 1 | NA | - | - | ✓ |
| TZ-PCT | Adjustable Cycle Controller w/ Adjustable Output | 120/240 | 1 | 28 | ✓ | ✓ | ✓ |
| TZ-TIMER | 0-60 Min Heavy Duty In-Wall On/Off Timer | 120/240 | 1 | 28 | ✓ | ✓ | ✓ |
| TZ-TIMER2HR | 0-120 Min Heavy Duty In-Wall On/Off Timer | 120/240 | 1 | 20 | ✓ | ✓ | ✓ |
| TZ-HUB | App Based Z-Wave Wireless Connection Hub | 120 | 1 | NA | ✓ | ✓ | ✓ |
| TZ-SWITCH | App Based Z-Wave Wireless Junction Box | 120/240 | 1 | 40 | ✓ | ✓ | ✓ |

*Optional controls suitable for isolated control of your heater(s), or to be paired with QMarks line of control panels to operate banks of heaters together. Options range from adjustable output cycle timers with fixed and adjustable cycle times, to standard on/off timer control, and introducing market leading Z-Wave app based control for easy operation from your phone."

Clearances:

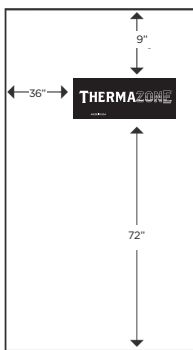

| CLEARANCES | Between Heaters | 36" | 36" |
|-------------|--|--|--|
| | To Side Walls | Wall Mounted: 4" Ceiling Mounted Vertical: 36" Ceiling Mounted Angled Away: 4" Ceiling Mounted Angled Toward: 72" | Wall Mounted: 7" Ceiling Mounted Vertical: 36" Ceiling Mounted Angled Away: 7" Ceiling Mounted Angled Toward: 72" |
| To Ceiling | Wall Mounted: 4" Ceiling Mounted Vertical: 4" Ceiling Mounted Angled Away: 4" Ceiling Mounted Angled Toward: 4" | Wall Mounted: 7" Ceiling Mounted Vertical: 4" Ceiling Mounted Angled Away: 7" Ceiling Mounted Angled Toward: 4" | |
| To Floor | 72" | 72" | |
| To Overhang | 18" | 12" | |

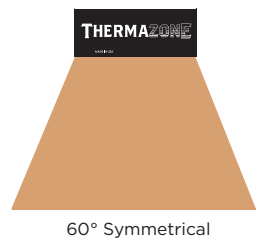
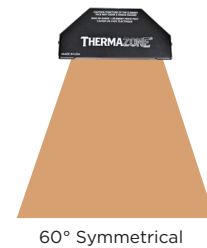

THERMAZONE SERIES

Infrared Heaters for Industrial/Commercial/Residential

Scan the QR code to access additional specs and features



Dimensions: 1' Thermazone Heater

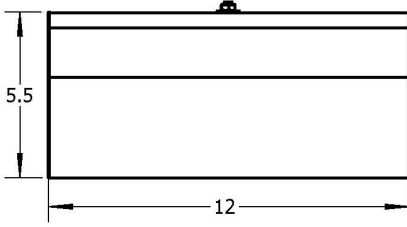

Dimensions: 2' Thermazone Heater

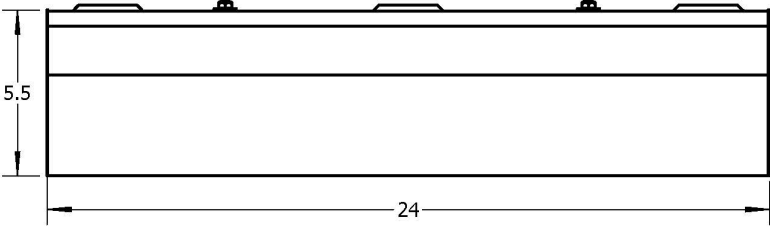

Dimensions: 4' Thermazone Heater

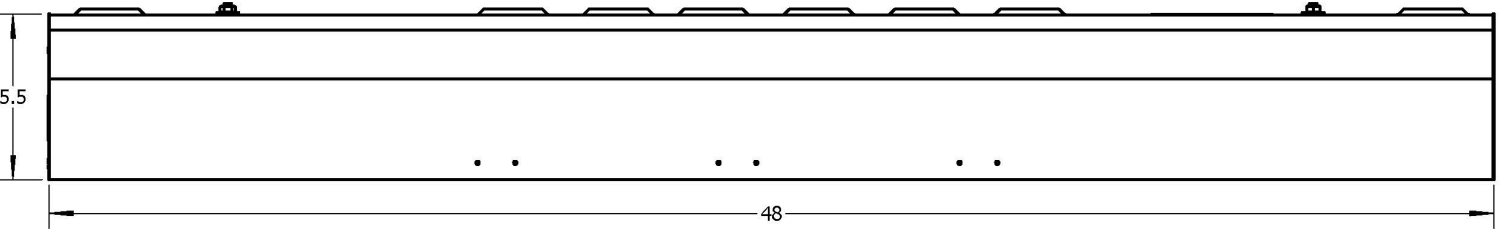

Dimensions: All Models - End View

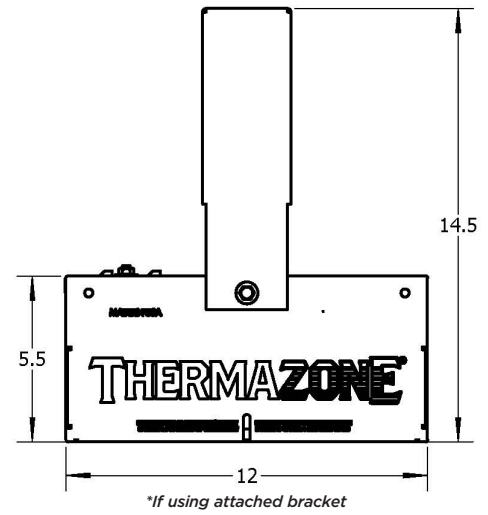

THERMAZONE THIN SERIES

Infrared Heaters for Industrial/Commercial/Residential

Dimensions: 18" Thermazone Thin Heater

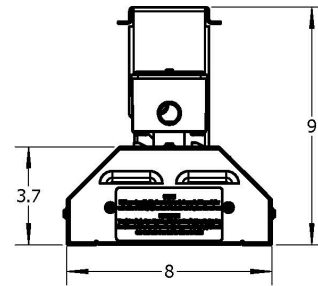
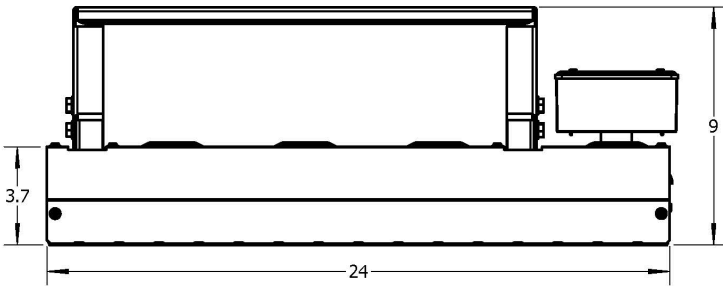

Dimensions: 36" Thermazone Thin Heater

