

**SUBMITTAL SHEET**  
**THERMAZONE THIN SERIES**

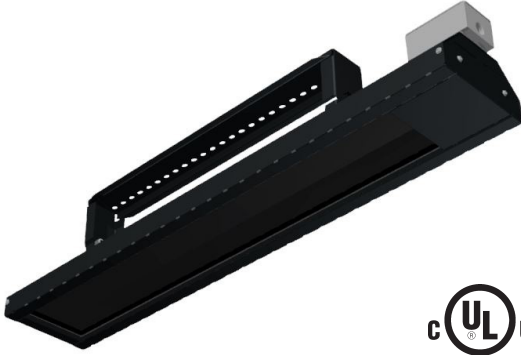

**CAPACITIES**

**Element Types:** flat panel emitter

Voltages: 120-240

Phase: single phase

Wattages: 1091 - 4322

**Mounting Types:**

- Ceiling Mount
- Wall Mount
- Hung by chain or threaded rod

**Reflection Angles:** 60 degrees

See Selection Chart for all Options

JOB NAME: \_\_\_\_\_

LOCATION: \_\_\_\_\_

ARCHITECT: \_\_\_\_\_

ENGINEER: \_\_\_\_\_

CONTRACTOR: \_\_\_\_\_

SUBMITTED BY: \_\_\_\_\_ DATE: \_\_\_\_\_

TAG/ITEM	QTY.	CATALOG NUMBER	HEATER			
			VOLTS	PHASE	WATTS	AMP

SUBMITTED BY:	DATE

APPROVED BY:	DATE

**THERMAZONE THIN SERIES- INFRARED HEATER FOR COMMERCIAL/RESIDENTIAL**

## ARCHITECT'S AND ENGINEER'S SPECIFICATIONS\*

The Thermazone electric infrared heater(s) shall be supplied Berko®, a Marley Engineered Products® Brand, Bennettsville, SC, USA, and shall be of the KW rating, voltage and phase specified in the schedule. They shall be radiant type, and certified to cULus listed under standard 2021.

**HEATING ASSEMBLY:** The heating assembly shall be cULus listed under standard 2021 and shall consist of single stranded, non-coiled Ni-Chrome wire embedded in vitrified ceramic fiber and backed with high density, low biopersistent Fiberfrax insulation. The emitting surface is covered with a black-coated high temperature fiberglass cloth.

**WIRING:** For connection to the power supply, Thermazone heaters will include an indoor/outdoor rate j-box mounted to the heater's raceway.

**CONSTRUCTION:** The heaters are formed and fastened together out of 16 ga. and 20 ga. CRS or stainless steel. If CRS, the heater must be powder coated with a high temp black finish. Unit may include a Stainless Steel grid on the face of the heater.

**MOUNTING:** The heater shall be provided with a mounting kit designed to bear the weight of the heater assembly. The construction and design shall permit it to be ceiling or wall mounted, with the use of the mounting brackets supplied, hung by chain or suspended with threaded rod.

**PERFORMANCE:** All units are engineered to operate at optimal performance with a 60 degree dissipation pattern. Each unit is designed to operate with medium or longwave infrared technology, for the most efficient delivery of heat for the desired space.

**OPTIONAL CONTROLS:** All infrared units are designed for compatibility to a variety of controls offered by Berko. Depending upon the voltage, wattage, and zoning requirements of the job, these controls may include one or a combination of the following: thermostat, timer, % timer, contactor panels, SSR panel, SCR panel, and/or Z-Wave mobile application based systems.

*\*Berko reserves the right to change specifications without prior notice.*

BERKO THERMAZONE THIN SERIES		SINGLE PHASE AMPERAGES		
18' Model	WATTAGE	120V	208V	240V
BR-STT-U18-1091B	1091	9.1	-	-
BR-STT-U18-1330B	1330	11.5	-	-
BR-STT-U18-1767B	1767	14.8	-	-
BR-STT-U18-2161B	2161	18.1	-	-
36" MODEL	WATTAGE	120V	208V	240V
BR-STT-U36-2180V	2180/1635	-	6.8	9.1
BR-STT-U36-2660V	2660/2071	-	8.6	11.5
BR-STT-U36-3104V	3104/2328	-	9.7	12.9
BR-STT-U36-3534V	3534/2661	-	11.1	14.8
BR-STT-U36-4322V	4322/3242	-	15.6	18.1

**THERMAZONE THIN SERIES**

**How to Order**

Example:

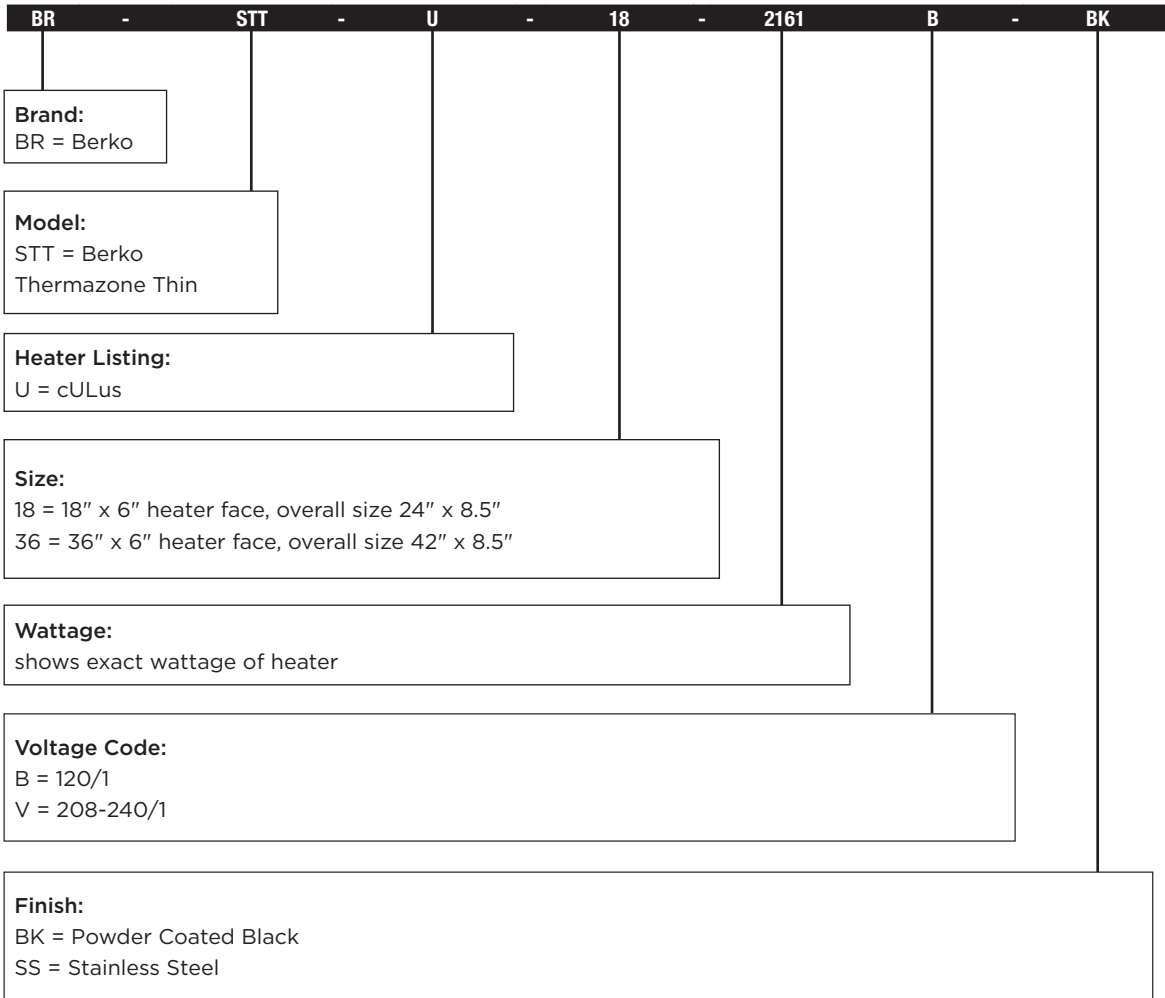

**Dimensions and Clearances:**

\*Reference product instruction manual for additional information on proper mounting, wiring, and installation.

**FOR WALL MOUNTING:**

Do not install the section closer than:

- 6-7/8 inches below a horizontal surface
- 12 inches to an adjacent vertical surface
- 36 inches to another heater
- 6 feet from the floor

For angle positioning, the heater should not be directed toward any vertical surface closer than 6 feet.

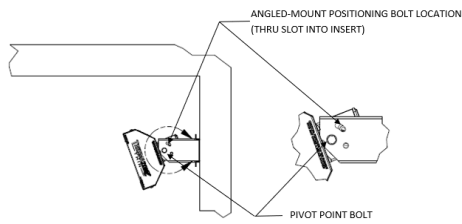

Fig. 1 - ANGLED POSITIONING FOR WALL MOUNTING

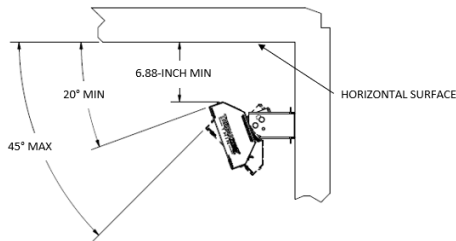

Fig. 2A - WALL MOUNTING

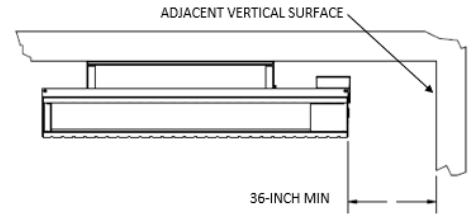

Fig. 2B - WALL MOUNTING

**FOR CEILING MOUNTING:**

Do not install the section closer than:

- 36 inches to a vertical surface for vertical mounting
- 6-7/8 inches to a vertical surface for angled ceiling mounting
- 12 inches to an adjacent vertical surface
- 36 inches to another heater
- 6 feet from the floor

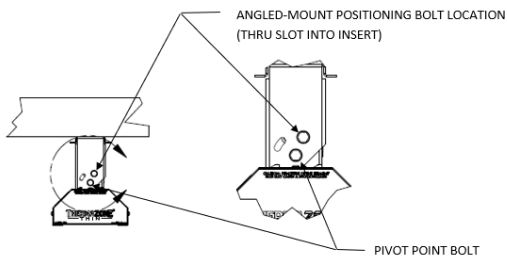

Fig. 3 - CEILING ONLY VERTICAL MOUNTING POSITIONING

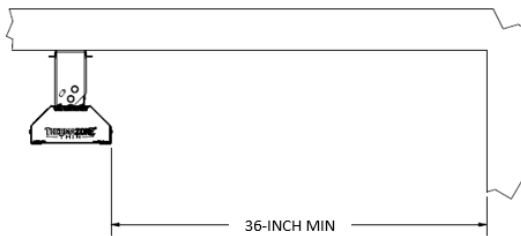

Fig. 4 - CEILING MOUNTING VERTICAL

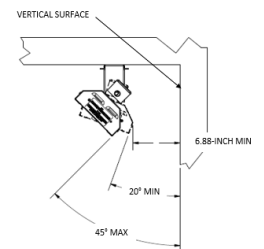

Fig. 5 - CEILING MOUNTING ANGLED AWAY FROM VERTICAL SURFACE

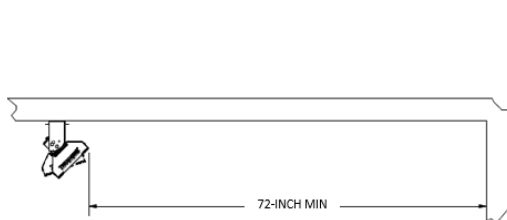

Fig. 6 - CEILING MOUNTING ANGLED TOWARDS VERTICAL SURFACE

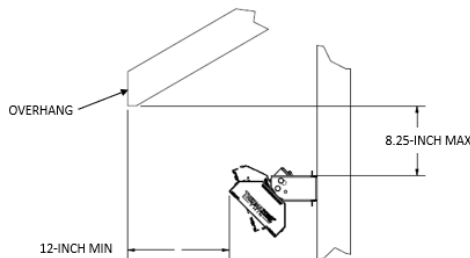

Fig. 7 - PROTECTED AREA WALL MOUNTING

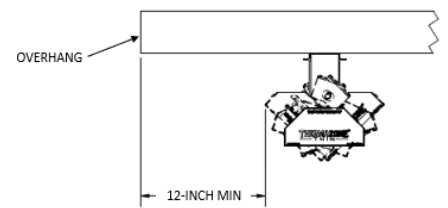
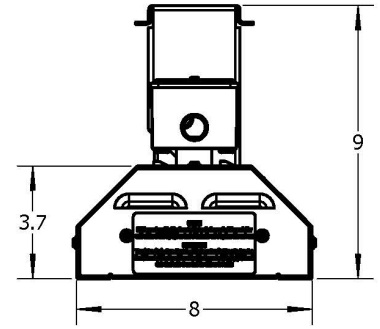
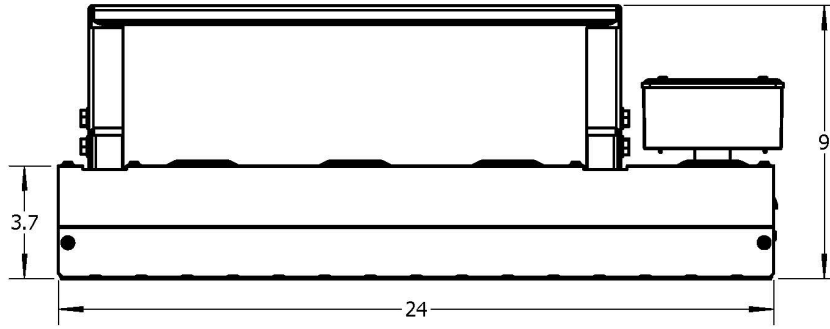

Fig. 8 - PROTECTED AREA CEILING MOUNTING

**THERMAZONE THIN SERIES**

*Dimensions: 18" Thermazone Thin Heater*



*Dimensions: 36" Thermazone Thin Heater*

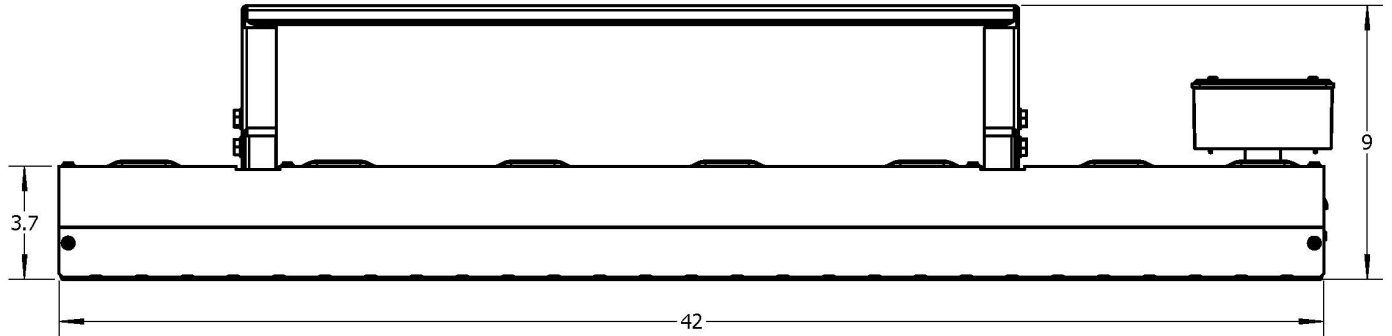

No matter the industry or application, Marley Engineered Products has a robust portfolio of innovative, reliable, high-performance comfort heating and ventilation solutions for all your heating needs.

For more information or assistance on your next project, contact Technical Services at 800-642-4328

Scan the QR code to access additional specs and features



Approvals: \_\_\_\_\_