

This catalog contains part numbers for the most common replacement parts for Berko heaters shown in the Table of Contents. Additional parts for these heaters may be available - consult factory for availability. Parts for Berko heaters not listed in the Table of Contents may be available - consult factory for availability.

TABLE OF CONTENTS

BASEBOARD	CEILING HEATERS	RADIANT
(2500 Series) 2	QCH 22	WRL 43
BKOC 2	QFF 22	XRM 44
Baseboard Accessories 4	FFCH 22	YRN 45
OBD 5		FFR 46
HBB 5		PMRR 46
	UNIT HEATERS	VRP & VRS 47
WALL HEATERS	CUH900 23	JRK 48
SSARWH 6	PHFP25 25	BHRA & BVRC 49
SSHOWH 7	HUH 26	RCC 50
HT 8	BDH 27	
MCSSAR 9	BSDH 28	PORTABLE
FRC (WH-FC) 10	BPH 29	QPH4A 33
FRA (WHB3000) 11	HUHA AFC 30	FBE 51
SRA (WHB1000) 12	HUH524TA & HUH724ST 32	LFP 51
SRA ARCHITECTURAL SERIES 13	PH5 33	FHP 52
VFK 14	TBX 34	WPC 53
GFR 15	BWD 35	
QFG 16		INDUSTRIAL PRODUCTS
SED 17	CONVECTORS	AIR CIRCULATORS 54
COS-E 18	UCJ 37	DRUM BLOWERS 64
MFQ 19	ASL 38	COMMERCIAL CEILING FANS 66
ECP 20	BDBSL 39	EXHAUST FANS 67
	ICST 40	AIR CURTAINS 69
SPECIALITY HEATERS	CSL 41	
QTS 21	CPL 41	
FDI 21	ASLC 42	
WHT 21		
CFWF 21		

OBsolete PRODUCTS

SOME PARTS MAY NO LONGER BE AVAILABLE FOR OBSOLETE PRODUCTS

BUILDER PRODUCTS

ALL BATH VENTS 73
GENERAL HOME/KITCHEN 83
ROOF VENTILATORS 84
WHOLE HOUSE FANS 85

WALL HEATERS

MFA 86
CRA 87
BVP 88
A2500 88
1235 & 2435 89
B2400 89
SR 90
SRA 91
FR 92
FRA 93
FRC 94

CEILING HEATERS

SCH 88

UNIT HEATERS

CUH 95
VUH 95
VUH-A 95
HUHAA 96
HUHAA 97

CONVECTORS

CC & DCC 98
DB 98

RADIANT

RH 99

AIR CIRCULATORS

LCHHD 99
LCHXN 99
LCHIN 99

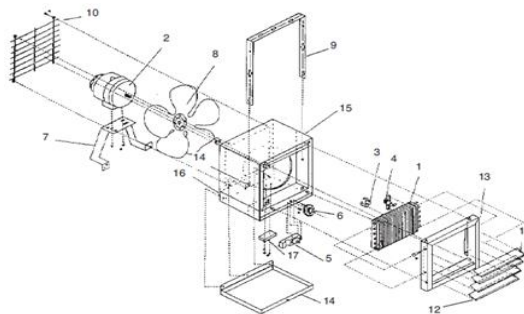









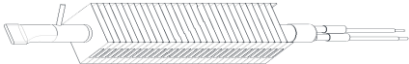



C2500 & 2500 SERIES CONTINUED







THERMAL CUTOUT



4520-2018-000	4520-2018-001	4520-2018-002	4520-2018-003	4520-2018-004
2502 2502A 2502B 2502NWC 2502NWCA 2502W 2502WA 2502WB 2502WCB 2502WCA 2502WCA 2512 2512A 2512B 2512NWC 2512NWCA 2512W 2512WA 2512WB 2512WCB 2512WCA 2512WCA 2542	25026 25026A 25026B 25026NWC 25026W 25026WA 25026WB 25026WCB 25026WCA 25026WCA 25126 25126A 25126B 25126NWC 25126NWCA 25126W 25126WA 25126WB 25126WCB 25126WCA 25126WCA 25426 25426A 25426B 25426NWC 25426W 25426WA 25426WB 25426WCB 25426WCA 25426WCA 25726 25726A 25726B 25726W 25726WCA	2503 2503A 2503B 2503NWC 2503NWCA 2503W 2503WA 2503WB 2503WCB 2503WCA 2503WCA 2513 2513A 2513B 2513NWC 2513NWCA 2513W 2513WA 2513WB 2513WCB 2513WCA 2513WCA 2543 2543A 2543B 2543NWC 2543W 2543WA 2543WB 2543WCB 2543WCA 2543WCA 2573 2573A 2573B 2573W 2573WCA	2504 2504A 2504B 2504NWC 2504NWCA 2504W 2504WA 2504WB 2504WCB 2504WCA 2504WCA 2514 2514A 2514B 2514NWC 2514NWCA 2514W 2514WA 2514WB 2514WCB 2514WCA 2514WCA 2544 2544A 2544B 2544NWC 2544W 2544WA 2544WB 2544WCB 2544WCA 2544WCA 2574 2574A 2574B 2574W 2574WCA	2505 2505A 2505B 2505NWC 2505NWCA 2505W 2505WA 2505WB 2505WCB 2505WCA 2505WCA 2515 2515A 2515B 2515NWC 2515NWCA 2515W 2515WA 2515WB 2515WCB 2515WCA 2515WCA 2545 2545A 2545B 2545NWC 2545W 2545WA 2545WB 2545WCB 2545WCA 2545WCA 2575 2575A 2575B 2575W 2575WCA
4520-2018-005	4520-2018-006	4520-2019-000	4520-2019-001	4520-2019-002
2506 2506A 2506B 2506NWC 2506NWCA 2506W 2506WA 2506WB 2506WCB 2506WCA 2506WCA 2516 2516A 2516B 2516NWC 2516NWCA 2516W 2516WA 2516WB 2516WCB 2516WCA 2516WCA 2546 2546A 2546B 2546NWC 2546NWCA 2546W 2546WA 2546WB 2546WCB 2546WCA 2546WCA 2576 2576A 2576B 2576W 2576WCA	2508 2508A 2508B 2508NWC 2508NWCA 2508W 2508WA 2508WB 2508WCB 2508WCA 2508WCA 2518 2518A 2518B 2518NWC 2518NWCA 2518W 2518WA 2518WB 2518WCB 2518WCA 2518WCA 2548 2548A 2548B 2548NWC 2548NWCA 2548W 2548WA 2548WB 2548WCB 2548WCA 2548WCA 2578 2578A 2578B 2578W 2578WCA	2502H 2502HA 2502HB 2502HNWC 2502HNWCA 2502HW 2502HWA 2502HWB 2502HWCB 2502HWCA 2502HWCA 2512H 2512HA 2512HB 2512HNWC 2512HNWCA 2512HW 2512HWA 2512HWB 2512HWCB 2512HWCA 2512HWCA 2542H 2542HA 2542HB 2542HNWC 2542HNWCA 2542HW 2542HWA 2542HWB 2542HWCB 2542HWCA 2542HWCA 2572H 2572HA 2572HB 2572HNWC 2572HNWCA 2572HW 2572HWA 2572HWB 2572HWCB 2572HWCA 2572HWCA	25026HA 25026HA 25026HB 25026HNWC 25026HNWCA 25026HW 25026HWA 25026HWB 25026HWCB 25026HWCA 25026HWCA 25126HA 25126HA 25126HB 25126HNWC 25126HNWCA 25126HW 25126HWA 25126HWB 25126HWCB 25126HWCA 25126HWCA 25426HA 25426HA 25426HB 25426HNWC 25426HNWCA 25426HW 25426HWA 25426HWB 25426HWCB 25426HWCA 25426HWCA 25726HA 25726HA 25726HB 25726HNWC 25726HNWCA 25726HW 25726HWA 25726HWB 25726HWCB 25726HWCA 25726HWCA	2503H 2503HA 2503HB 2503HNWC 2503HNWCA 2503HW 2503HWA 2503HWB 2503HWCB 2503HWCA 2503HWCA 2513H 2513HA 2513HB 2513HNWC 2513HNWCA 2513HW 2513HWA 2513HWB 2513HWCB 2513HWCA 2513HWCA 2543H 2543HA 2543HB 2543HNWC 2543HNWCA 2543HW 2543HWA 2543HWB 2543HWCB 2543HWCA 2543HWCA 2573H 2573HA 2573HB 2573HNWC 2573HNWCA 2573HW 2573HWA 2573HWB 2573HWCB 2573HWCA 2573HWCA
4520-2019-005	4520-2019-006	4520-2019-003	4520-2019-004	
2506H 2506HA 2506HB 2506HNWC 2506HNWCA 2506HW 2506HWA 2506HWB 2506HWCB 2506HWCA 2516H 2516HA 2516HB 2516HNWC 2516HNWCA 2516HW 2516HWA 2516HWB 2516HWCB 2516HWCA 2516HWCA 2546H 2546HA 2546HB 2546HNWC 2546HNWCA 2546HW 2546HWA 2546HWB 2546HWCB 2546HWCA 2546HWCA 2576H 2576HA 2576HB 2576HNWC 2576HNWCA 2576HW 2576HWA 2576HWB 2576HWCB 2576HWCA 2576HWCA	2508H 2508HA 2508HB 2508HNWC 2508HNWCA 2508HW 2508HWA 2508HWB 2508HWCB 2508HWCA 2508HWCA 2518H 2518HA 2518HB 2518HNWC 2518HNWCA 2518HW 2518HWA 2518HWB 2518HWCB 2518HWCA 2518HWCA 2548H 2548HA 2548HB 2548HNWC 2548HNWCA 2548HW 2548HWA 2548HWB 2548HWCB 2548HWCA 2548HWCA 2578H 2578HA 2578HB 2578HNWC 2578HNWCA 2578HW 2578HWA 2578HWB 2578HWCB 2578HWCA 2578HWCA	2504H 2504HA 2504HB 2504HNWC 2504HNWCA 2504HW 2504HWA 2504HWB 2504HWCB 2504HWCA 2504HWCA 2514H 2514HA 2514HB 2514HNWC 2514HNWCA 2514HW 2514HWA 2514HWB 2514HWCB 2514HWCA 2514HWCA 2544H 2544HA 2544HB 2544HNWC 2544HNWCA 2544HW 2544HWA 2544HWB 2544HWCB 2544HWCA 2544HWCA 2574H 2574HA 2574HB 2574HNWC 2574HNWCA 2574HW 2574HWA 2574HWB 2574HWCB 2574HWCA 2574HWCA	2505H 2505HA 2505HB 2505HNWC 2505HNWCA 2505HW 2505HWA 2505HWB 2505HWCB 2505HWCA 2505HWCA 2515H 2515HA 2515HB 2515HNWC 2515HNWCA 2515HW 2515HWA 2515HWB 2515HWCB 2515HWCA 2515HWCA 2545H 2545HA 2545HB 2545HNWC 2545HNWCA 2545HW 2545HWA 2545HWB 2545HWCB 2545HWCA 2545HWCA 2575H 2575HA 2575HB 2575HNWC 2575HNWCA 2575HW 2575HWA 2575HWB 2575HWCB 2575HWCA 2575HWCA	

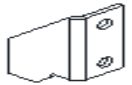
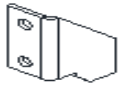

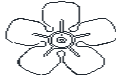
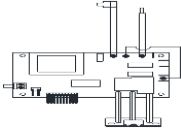

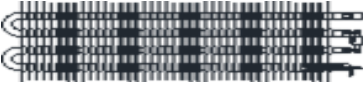
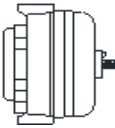
HBB SERIES BASEBOARD											
ELEMENT						LIMIT					
											
1802-2068-000	1802-2068-001	1802-2068-002	1802-2068-003	1802-2068-004	1802-2068-016	410122002	410122003	410122004	410122005	410122006	410122008
500D	7500D	1000D	1250D	1500D	2004D	500D	7500D	1000D	1250D	1500D	2004D
500DA	7500DA	1000DA	1250DA	1500DA	2004DA	500DA	7500DA	1000DA	1250DA	1500DA	2004DA
500DB	7500DB	1000DB	1250DB	1500DB	2004DB	500DB	7500DB	1000DB	1250DB	1500DB	2004DB
1802-2068-011	1802-2068-012	1802-2068-013	1802-2068-014	1802-2068-015	1802-2068-010	504D	7504D	1004D	1254D	1504D	2007D
504D	7504D	1004D	1254D	1504D	2008D	504DA	7504DA	1004DA	1254DA	1504DA	2007DA
504DA	7504DA	1004DA	1254DA	1504DA	2008DA	504DB	7504DB	1004DB	1254DB	1504DB	2007DB
504DB	7504DB	1004DB	1254DB	1504DB		508D	7507D	1007D	1257D	1507D	2008DB
1802-2068-005	1802-2068-006	1802-2068-007	1802-2068-008	1802-2068-009		508DA	7508D	1008D	1258D	1508D	
508D	7508D	1008D	1258D	1508D		508DA	7508DA	1008DA	1258DA	1508DA	
508DA	7508DA	1008DA	1258DA	1508DA		508DB	7508DB	1008DB	1258DB	1508DB	
508DB	7508DB	1008DB	1258DB	1508DB							
FRONT COVER						GRILLE					
											
1402-2066-000	1402-2066-001	1402-2066-002	1402-2066-003	1402-2066-004	1402-2066-005	2501-2012-012	2501-2012-013	2501-2012-014	2501-2012-015	2501-2012-010	2501-2012-011
500D	7500D	1000D	1250D	1500D	2004D	500D	7500D	1000D	1250D	1500D	2004D
500DA	7500DA	1000DA	1250DA	1500DA	2004DA	500DA	7500DA	1000DA	1250DA	1500DA	2004DA
500DB	7500DB	1000DB	1250DB	1500DB	2004DB	500DB	7500DB	1000DB	1250DB	1500DB	2004DB
504D	7504D	1004D	1254D	1504D	2007D	504D	7504D	1004D	1254D	1504D	2007D
504DA	7504DA	1004DA	1254DA	1504DA	2008D	504DA	7504DA	1004DA	1254DA	1504DA	2008D
504DB	7504DB	1004DB	1254DB	1504DB	2008DA	504DB	7504DB	1004DB	1254DB	1504DB	2008DA
508D	7507D	1007D	1257D	1507D	2008DB	508D	7507D	1007D	1257D	1507D	2008DB
508DA	7508D	1008D	1258D	1508D		508DA	7508D	1008D	1258D	1508D	
508DB	7508DA	1008DA	1258DA	1508DA		508DB	7508DA	1008DA	1258DA	1508DA	
508DB	7508DB	1008DB	1258DB	1508DB							
JUNCTION BOX COVER ALL MODELS 1800-2022-000											
											
OBD SERIES BASEBOARD											
ELEMENT						LIMIT					
											
1802-2056-007	1802-2056-011	1802-2063-017	1802-2063-023	1802-2094-015	1802-2063-033	4520-2018-001	4520-2018-002	4520-2018-003	4520-2018-004	4520-2018-005	4520-2018-006
D500	D750	D1000	D1250	D1500	D2004	D500	D750	D1000	D1250	D1500	D2004
D500A	D750A	D1000A	D1250A	D1500A	D2004A	D500A	D750A	D1000A	D1250A	D1500A	D2004A
1802-2056-005	1802-2056-009	1802-2063-015	1802-2063-021	1802-2063-027	1802-2063-032	D504	D754	D1004	D1254	D1504	D2007
D504	D754	D1004	D1254	D1504	D2007	D504A	D754A	D1004A	D1254A	D1504A	D2007A
D504A	D754A	D1004A	D1254A	D1504A	D2007A	D507	D757	D1007	D1256	D1507	D2008
1802-2056-004	1802-2056-008	1802-2063-014	1802-2063-047	1802-2063-026	1802-2063-034	D507A	D757A	D1007A	D1256A	D1507A	D2008A
D507	D757	D1007	D1256	D1507	D2008	D507A	D757A	D1007A	D1256A	D1507A	D2008A
D507A	D757A	D1007A	D1256A	D1507A	D2008A	D508	D758	D1008	D1257	D1508	
1802-2056-006	1802-2056-010	1802-2063-016	1802-2063-020	1802-2063-028		D508A	D758A	D1008A	D1257A	D1508A	
D508	D758	D1008	D1257	D1508		D508A	D758A	D1008A	D1257A	D1508A	
D508A	D758A	D1008A	D1257A	D1508A							
			1802-2063-022								
			D1258								
			D1258A								
FRONT COVER						GRILLE					
											
1402-2066-010	1402-2066-011	1402-2066-012	1402-2066-013	1402-2066-014	1402-2066-015	2501-2012-012	2501-2012-013	2501-2012-014	2501-2012-015	2501-2012-010	2501-2012-011
D500	D750	D1000	D1250	D1500	D2004	D500	D750	D1000	D1250	D1500	D2004
D500A	D750A	D1000A	D1250A	D1500A	D2004A	D500A	D750A	D1000A	D1250A	D1500A	D2004A
D504	D754	D1004	D1254	D1504	D2007	D504	D754	D1004	D1254	D1504	D2007
D504A	D754A	D1004A	D1254A	D1504A	D2007A	D504A	D754A	D1004A	D1254A	D1504A	D2007A
D507	D757	D1007	D1256	D1507	D2008	D507A	D757A	D1007A	D1256A	D1507A	D2008A
D507A	D757A	D1007A	D1256A	D1507A	D2008A	D508	D758	D1008	D1257	D1508	
D508	D758	D1008	D1257	D1508		D508A	D758A	D1008A	D1257A	D1508A	
D508A	D758A	D1008A	D1257A	D1508A							
			D1258								
			D1258A								
JUNCTION BOX COVER ALL MODELS 1800-2022-000											
											
SEE ACCESSORIES ON 2500 SERIES PAGE FOR T1 & T2 THERMOSTAT PARTS											

ARWH SERIES



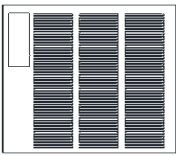
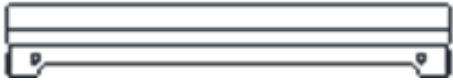

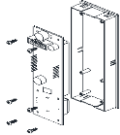
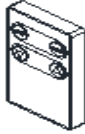
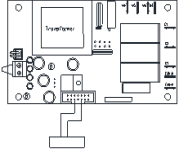
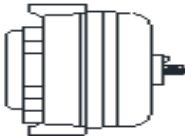

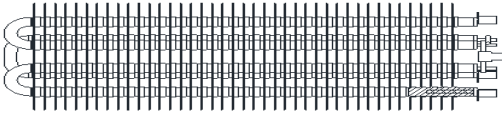
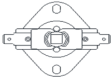
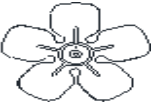

RIGHT BEZEL	LEFT BEZEL	DISPLAY ASSM.	BOTTOM BRACKET LT.	BOTTOM BRACKET RT.	REMOTE	EOL LIMIT	FAN BLADE
							
1219-11009-001 ALL MODELS	1219-11009-000 ALL MODELS	1016-11188-000 ALL MODELS	1215-11070-000 ALL MODELS	1215-11070-001 ALL MODELS	1414-11037-000 ALL MODELS	1414-11046-000 ALL MODELS	490030103 ALL MODELS
PWR CONTROL BOARD			DISCONNECT SWITCH	ELEMENT			
							
1414-11033-002 ARWH1802 ARWH1802AL ARWH1802BZ ARWH1802W	1414-11033-001 ARWH4807 ARWH4807AL ARWH4807BZ ARWH4807W	1414-11033-000 ARWH4808 ARWH4804 ARWH4808AL ARWH4804AL ARWH4808BZ ARWH4804BZ ARWH4808W ARWH4804W	410170001 ARWH1802 ARWH1802AL ARWH1802BZ ARWH1802W ARWH4804 ARWH4804AL ARWH4804BZ ARWH4804W ARWH4807 ARWH4807AL ARWH4807BZ ARWH4807W	302012828 ARWH1802 ARWH1802AL ARWH1802BZ ARWH1802W	1802-2075-801 ARWH4808 ARWH4808AL ARWH4808BZ ARWH4808W	302012810 ARWH4804 ARWH4804AL ARWH4804BZ ARWH4804W	302012811 ARWH4807 ARWH4807AL ARWH4807BZ ARWH4807W
MOTOR							
3900-11026-002 ARWH1802 ARWH1802AL ARWH1802BZ ARWH1802W	3900-11026-001 ARWH4807 ARWH4807AL ARWH4807BZ ARWH4807W	3900-11026-000 ARWH4808 ARWH4804 ARWH4808AL ARWH4804AL ARWH4808BZ ARWH4804BZ ARWH4808W ARWH4804W					

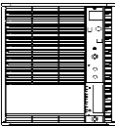

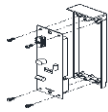
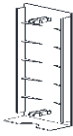

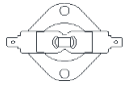
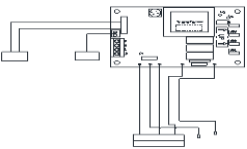
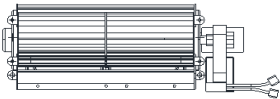

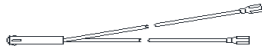

SSHO SERIES

GRILLE			GRILLE TABS (2 REQ)			LIGHT
						
2501-11022-000 HOSS4004 HOSS4007 HOSS4008	2501-11022-001 HOSS4004SB HOSS4007SB HOSS4008SB	2501-11022-002 HOSS4004NV HOSS4007NV HOSS408NV	1402-2120-002 HOSS4004 HOSS4007 HOSS4008	1402-2120-001 HOSS4004SB HOSS4007SB HOSS4008SB	1402-2120-000 HOSS4004NV HOSS4007NV HOSS408NV	3510-2017-005 ALL MODELS
DISPLAY ASSM.	REMOTE	CTRL PWR BOARD		MOTOR		DISCONNECT SWITCH
						
1016-11199-000 ALL MODELS	1414-11037-000 ALL MODELS	1414-11043-000 HOSS4004 HOSS4004NV HOSS4004SB HOSS4008 HOSS408NV HOSS4008SB	1414-11043-001 HOSS4007 HOSS4007NV HOSS4007SB	3900-2002-522 HOSS4004 HOSS4004NV HOSS4004SB HOSS4008 HOSS408NV HOSS4008SB	3900-2002-523 HOSS4007 HOSS4007NV HOSS4007SB	410170001 ALL MODELS
ELEMENT			MANUAL LIMIT	FAN BLADE		
						
1802-11005-000 HOSS4008 HOSS408NV HOSS4008SB	1802-11005-001 HOSS4004 HOSS4004NV HOSS4004SB	1802-11005-002 HOSS4007 HOSS4007NV HOSS4007SB	4520-2027-000 ALL MODELS	490030103 ALL MODELS		

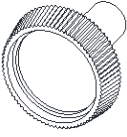
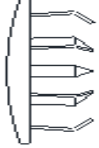
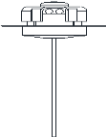

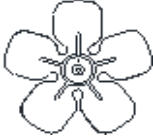

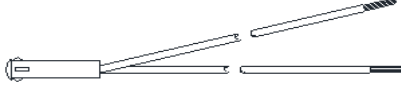
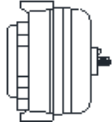
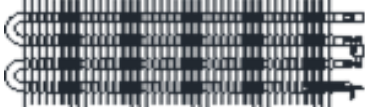





HT SMART SERIES







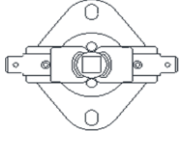

GRILLE PANEL		GRILLE ASSY INSERT		DISPLAY BEZEL	BOTTOM BEZEL	REMOTE	MANUAL LIMIT
							
2501-11003-003 HT1502SS HT2024SS	2501-11003-004 HT1502SSNW HT2024SSNW	1016-11063-000 HT1502SS HT2024SS	1016-11063-001 HT1502SSNW HT2024SSNW	1016-11035-003 HT1502SS HT2024SS HT1502SSNW HT2024SSNW	1219-11004-000 ALL MODELS	1414-11017-001 ALL MODELS	4520-11005-000 ALL MODELS
CNTRL PWR BOARD		BLOWER MOTOR		ELEMENT		LIGHT	
							
1414-11007-002 HT1502SS HT1502SSNW	1414-11007-003 HT2024SS HT2024SSNW	1225-11001-000 HT1502SS HT1502SSNW	1225-11001-001 HT2024SS HT2024SSNW	302023802 HT1502SS HT1502SSNW	302023805 HT2024SS HT2024SSNW	3510-2010-000 HT1502SS HT1502SSNW	3510-2010-001 HT2024SS HT2024SSNW
							

MCSSAR SERIES

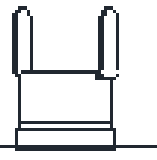



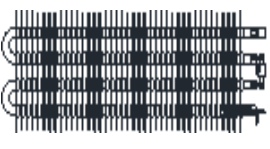



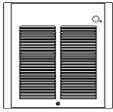
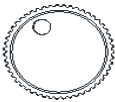

KNOB	PLUG BUTTON	MANUAL RESET	THERMAL FUSE	FAN BLADE	THERMOSTAT
					
3301-11013-000 ALL MODELS	4506-2012-009 ALL MODELS	4520-11019-000 ALL MODELS	4520-2030-000 ALL MODELS	490030103 ALL MODELS	5813-2027-001 ALL MODELS
FAN DELAY			LIGHT		
					
1414-2039-000 MCARWH1802 MCARWH1802AL MCARWH1802BZ MCARWH1802W	410074000 MCARWH4804 MCARWH4804AL MCARWH4804BZ MCARWH4804W MCARWH4807 MCARWH4807AL MCARWH4807AL	MCARWH4807BZ MCARWH4807W MCARWH4808 MCARWH4808AL MCARWH4808BZ MCARWH4808W	3510-2017-000 MCARWH1802 MCARWH1802AL MCARWH1802BZ MCARWH1802W	3510-2017-001 MCARWH4804 MCARWH4804AL MCARWH4804BZ MCARWH4804W MCARWH4807 MCARWH4807AL	MCARWH4807BZ MCARWH4807W MCARWH4808 MCARWH4808AL MCARWH4808BZ MCARWH4808W
MOTOR			ELEMENT		DISCONNECT SWITCH
					
3900-2010-003 MCARWH1802 MCARWH1802AL MCARWH1802BZ MCARWH1802W	3900-2010-000 MCARWH4804 MCARWH4804AL MCARWH4804BZ MCARWH4804W MCARWH4808 MCARWH4808AL MCARWH4808BZ MCARWH4808W	3900-2010-001 MCARWH4807 MCARWH4807AL MCARWH4807BZ MCARWH4807W	302012828 MCARWH1802 MCARWH1802AL MCARWH1802BZ MCARWH1802W 302012811 MCARWH4807 MCARWH4807AL MCARWH4807BZ MCARWH4807W	302012810 MCARWH4804 MCARWH4804AL MCARWH4804BZ MCARWH4804W 302012807 MCARWH4808 MCARWH4808AL MCARWH4808BZ MCARWH4808W	410170001 ALL MODELS 

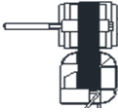
WH-FC SERIES (FRC)













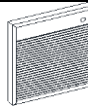

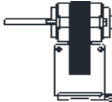
GRILLE		ELEMENTS				DISCONNECT SWITCH				
										
1016-11225-000 WH3150FC WH44083FC WH3180FC WH4503FC WH4303FC WH4504FC WH4306FC WH45043FC WH4307FC WH4506FC WH4404FC WH4507FC WH44043FC WH4508FC WH4407FC WH45083FC WH4408FC		1016-11225-001 WH3150FCNW WH44083FCNW WH3180FCNW WH4503FCNW WH4303FCNW WH4504FCNW WH4306FCNW WH45043FCNW WH4307FCNW WH4506FCNW WH4404FCNW WH4507FCNW WH44043FCNW WH4508FCNW WH4407FCNW WH45083FCNW WH4408FCNW		302012806 WH4307FC WH4307FCNW 302012824 WH4506FC WH4506FCNW 302012808 WH4404FC WH4404FCNW 302012827 WH3150FC WH3150FCNW	302012809 WH4407FC WH4407FCNW 302012829 WH3180FC WH3180FCNW 302012807 WH4408FC WH4408FCNW 302012820 WH4306FC WH4306FCNW	302012810 WH4504FC WH4504FCNW 302012811 WH4507FC WH4507FCNW 302012819 WH4303FC WH4303FCNW 302012823 WH4503FC WH4503FCNW	1802-2075-802 WH44043FC WH44043FCNW WH44083FC WH44083FCNW 1802-2075-803 WH45043FC WH45043FCNW 1802-2075-801 WH4508FC WH4508FCNW WH45083FC WH45083FCNW	410170001 WH3150FC WH4407FC WH3150FCNW WH4407FCNW WH3180FC WH4408FC WH3180FCNW WH4408FCNW WH4307FC WH4504FC WH4307FCNW WH4504FCNW WH4404FC WH4507FC WH4404FCNW WH4507FCNW	5216-2019-000 WH4303FC WH4503FCNW WH4303FCNW WH45043FC WH4306FC WH4506FCNW WH4306FCNW WH4506FC WH44043FC WH4506FCNW WH44043FCNW WH4508FC WH44083FC WH4508FCNW WH44083FCNW WH45083FC WH4503FC WH45083FCNW	
MOTOR		FAN DELAY		RELAY		TRANSFORMER				
										
3900-2010-000 WH4303FC WH4408FCNW WH4303FCNW WH4503FC WH4306FC WH4503FCNW WH4306FCNW WH4504FC WH4404FC WH4504FCNW WH4404FCNW WH4506FC WH4408FC WH4506FCNW		3900-2010-001 WH4507NW WH4307FC WH4307FCNW WH4407FC WH4407FCNW WH4507FC WH4507FCNW	3900-2010-003 WH3150FC WH3150FCNW WH3180FC WH3180FCNW	3900-2002-518 WH44043FC WH44043FCNW WH44083FC WH44083FCNW WH45043FC WH45043FCNW WH4508FC WH4508FCNW WH45083FC WH45083FCNW	410074000 WH3150FC WH4407FC WH3150FCNW WH4407FCNW WH3180FC WH4408FC WH3180FCNW WH4408FCNW WH4303FC WH4503FC WH4303FCNW WH4503FCNW WH4306FC WH4504FC WH4306FCNW WH4504FCNW WH4307FC WH4506FC WH4307FCNW WH4506FCNW WH4404FC WH4507FC WH4404FCNW WH4507FCNW	4520-2024-000 WH44043FC WH44043FCNW WH44083FC WH44083FCNW WH45043FC WH45043FCNW WH4508FC WH4508FCNW WH45083FC WH45083FCNW	5018-2017-000 WH44043FC WH44043FCNW WH45043FC WH45043FCNW	5018-2017-004 WH44083FC WH44083FCNW WH4508FC WH4508FCNW WH45083FC WH45083FCNW	490015017 WH4303FC WH4303FCNW WH4503FC WH4503FCNW	490015013 WH4306FC WH4306FCNW WH4506FC WH4506FCNW
THERMOSTAT	MANUAL LIMIT	FAN BLADE								
										
410168002 ALL MODELS	4520-2027-000 ALL MODELS	490030103 ALL MODELS								





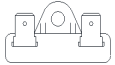









WHB (FRA-F)					
GRILLE	MANUAL LIMIT	FAN BLADE	THERMOSTAT	FAN DELAY	RELAY
					
1016-11226-000 WHB3150FC WHB3180C WHB3307FC WHB3404FC WHB34043FC WHB3407FC WHB3408FC WHB34083FC WHB3504FC WHB35043FC WHB3507FC WHB3508FC WHB35083FC	4520-2027-000 WHB3150FC WHB3180C WHB3307FC WHB3404FC WHB34043FC WHB3407FC WHB3408FC WHB34083FC WHB3504FC WHB35043FC WHB3507FC WHB3508FC WHB35083FC	490030103 WHB3150FC WHB3180C WHB3307FC WHB3404FC WHB34043FC WHB3407FC WHB3408FC WHB34083FC WHB3504FC WHB35043FC WHB3507FC WHB3508FC WHB35083FC	5813-2059-000 WHB3150FC WHB3180C WHB3307FC WHB3404FC WHB34043FC WHB3407FC WHB3408FC WHB34083FC WHB3504FC WHB35043FC WHB3507FC WHB3508FC WHB35083FC	410074000 WHB3150FC WHB3180C WHB3307FC WHB3404FC WHB34043FC WHB3407FC WHB3408FC WHB34083FC WHB3504FC WHB35043FC WHB3507FC WHB3508FC WHB35083FC	5018-2017-000 WHB34043FC WHB35043FC 5018-2017-004 WHB34083FC WHB3508FC WHB35083FC
DISCONNECT SWITCH		ELEMENT		MOTOR	
					
410170001 WHB3150FC WHB3180C WHB3307FC WHB3404FC WHB3407FC WHB3408FC WHB3504FC WHB3507FC	5216-2019-000 WHB34043FC WHB34083FC WHB35043FC WHB3508FC WHB35083FC	302012827 WHB3150FC 302012807 WHB3408FC 302012828 WHB3180C 302012806 WHB3307FC 302012808 WHB3404FC 302012809 WHB3407FC 302012810 WHB3504FC	302012811 WHB3507FC 1802-2075-800 WHB34083FC 1802-2075-801 WHB3508FC WHB35083FC 1802-2075-802 WHB34043FC 1802-2075-803 WHB35043FC	3900-2010-003 WHB3150FC WHB3180C 3900-2010-001 WHB3307FC WHB3507FC WHB3407FC 3900-2010-000 WHB3404FC WHB3408FC WHB3504FC	3900-2002-518 WHB34043FC WHB34083FC WHB35043FC WHB3508FC WHB35083FC 
PARTS KIT P/N 1205-11031-001 (KNOB, GRILLE SCREWS, AND PLUG BUTTONS)					







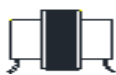
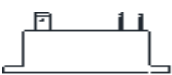



WHB SERIES (SRA)





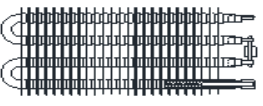
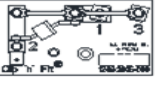

GRILLE		KNOB		ELEMENT		MOTOR					
											
1016-11228-000 WHB1101FC WHB1151FC WHB1157FC WHB1201FC WHB1202FC WHB1207FC WHB1208FC		3301-11015-001 WHB1101FC WHB1151FC WHB1157FC WHB1201FC WHB1202FC WHB1207FC WHB1208FC		302023801 WHB1101FC 302023802 WHB1151FC 302023803 WHB1157FC 302023804 WHB1208FC		302023805 WHB1202FC 302023806 WHB1207FC 302023808 WHB1201FC		490062001 WHB1101FC WHB1151FC WHB1201FC 490062003 WHB1208FC WHB1202FC		490062004 WHB1157FC WHB1207FC	
LIGHT		THERMAL FUSE		MANUAL LIMIT		THERMOSTAT					
											
3510-2017-007 WHB1101FC WHB1151FC WHB1201FC		3510-2017-006 WHB1157FC WHB1202FC WHB1207FC WHB1208FC		4520-2030-000 WHB1101FC WHB1151FC WHB1157FC WHB1201FC WHB1202FC WHB1207FC WHB1208FC		4520-11016-000 WHB1101FC WHB1151FC WHB1157FC WHB1201FC WHB1202FC WHB1207FC WHB1208FC		5813-2001-000 WHB1101FC WHB1151FC WHB1157FC WHB1202FC WHB1207FC WHB1208FC		5813-2022-000 WHB1201FC	
DISCONNECT SWITCH		FAN BLADE		FAN DELAY							
											
410170001 ALL MODELS		490061001 ALL MODELS		410074000 ALL MODELS							



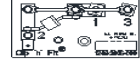

SRA ARCHITECTURAL SERIES (SWH)

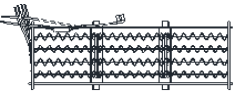
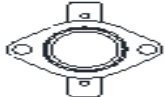
KNOB		GRILLE		ELEMENT		
						
3301-11015-003 SWH1012FC SWH1512FC SWH1527FC SWH1812FC SWH2020FC SWH2024FC SWH2027FC	3301-2052-002 SWH1012AG SWH1512AG SWH1527AG SWH1812AG SWH2020AG SWH2024AG SWH2027AG SWH1012AGA SWH1512AGA SWH1527AGA SWH1812AGA SWH2020AGA SWH2024AGA SWH2027AGA	1016-11227-000 SWH1012FC SWH1512FC SWH1527FC SWH1812FC SWH2020FC SWH2024FC SWH2027FC	2501-2075-000 SWH1012AG SWH1512AG SWH1527AG SWH1812AG SWH2020AG SWH2024AG SWH2027AG SWH1012AGA SWH1512AGA SWH1527AGA SWH1812AGA SWH2020AGA SWH2024AGA SWH2027AGA	302023801 SWH1012AG SWH1012AGA SWH1012FC 302023804 SWH2020AG SWH2020AGA SWH2020FC 302023808 SWH1812AG SWH1812AGA SWH1812FC	302023802 SWH1512AG SWH1512AGA SWH1512FC 302023805 SWH2024AG SWH2024AGA SWH2024FC	302023803 SWH1527AG SWH1527AGA SWH1527FC 302023806 SWH2027AG SWH2027AGA SWH2027FC
LIGHT			MOTOR		DISCONNECT SWITCH	
						
3510-2008-002 SWH1527AG	3510-2008-003 SWH1012AG SWH1512AG SWH1812AG SWH2020AG SWH2024AG SWH2027AG	3510-2017-007 SWH1012AGA SWH1512AGA SWH1812AGA SWH1012FC SWH1512FC SWH1812FC	3510-2017-006 SWH1527AGA SWH2020AGA SWH2024AGA SWH2027AGA SWH1527FC SWH2020FC SWH2024FC SWH2027FC	490062001 SWH1012AG SWH1512AG SWH1812AG SWH1012AGA SWH1512AGA SWH1812AGA SWH1012FC SWH1512FC SWH1812FC 490062002 SWH2020AG SWH2020AGA SWH2020FC	490062003 SWH2024AG SWH2024AGA SWH2024FC 490062004 SWH1527AG SWH2027AG SWH1527AGA SWH2027AGA SWH1527FC SWH2027FC	410170001 ALL MODELS
FAN DELAY	HI LIMIT	MANUAL LIMIT	FAN BLADE	THERMAL FUSE	THERMOSTAT	
						
410074000 ALL MODELS	410143000 SWH1012AG SWH1512AG SWH1527AG SWH1812AG SWH2020AG SWH2024AG SWH2027AG	4520-11016-000 SWH1012AGA SWH1512AGA SWH1527AGA SWH1812AGA SWH2020AGA SWH2024AGA SWH2027AGA SWH1012FC SWH1512FC SWH1527FC SWH1812FC SWH2020FC SWH2024FC SWH2027FC	490061001 ALL MODELS	4520-2030-000 SWH1012AGA SWH1512AGA SWH1527AGA SWH1812AGA SWH2020AGA SWH2024AGA SWH2027AGA SWH1012FC SWH1512FC SWH1527FC SWH1812FC SWH2020FC SWH2024FC SWH2027FC	5813-2022-000 SWH1812AG SWH1812AGA SWH1812FC	5813-2001-000 SWH1012AG SWH1512AG SWH1527AG SWH2020AG SWH2024AG SWH2027AG SWH1012AGA SWH1512AGA SWH1527AGA SWH2020AGA SWH2024AGA SWH2027AGA SWH1012FC SWH1512FC SWH1527FC SWH2020FC SWH2024FC SWH2027FC
						

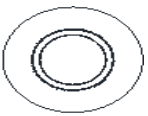

VFK-SERIES									
GRILLE			KNOB			FAN DELAY			MANUAL LIMIT
									
1402-2239-000 K151 K157A K204A K207A K208A K303A K304A K306A K307A K403A K404A K4043A K406A K407A K408A K4083A K483A K484A K4843A K486A K487A K488A K4883A	1402-2152-000 K204 K207 K208 K303 K304 K306 K307 K403 K404 K4043 K406 K408 K4083 K483 K484 K486 K488 K4883	2501-11028-000 K151FC K204FC K303FC K304FC K306FC K403FC K404FC K406FC K408FC K4083FC K483FC K484FC K486FC K487FC K488FC K4883FC	3301-2030-001 K151 K204 K207A K208 K303 K304 K306 K307A K403 K404 K4043A K406A K407A K408A K4083A K483 K484 K4843A K486A K487A K488A K4883A K157A		3301-11014-001 K151FC K204FC K303FC K304FC K306FC K403FC K404FC K406FC K408FC K4083FC K483FC K484FC K486FC K487FC K488FC K4883FC	4520-2024-000 K4043 K4043A K4083 K4083A K4083FC K4843 K4843A K488 K4883 K488A K4883A K4883FC	410074000 K204 K204A K204FC K208 K208A K303 K303A K303FC K304 K304A K304FC K306 K306A K306FC K403 K403A K403FC K404 K404A K404FC K406 K406A K406FC		4520-2027-000 ALL MODELS
ELEMENTS 				MOTOR 				FAN BLADE 	
302012827 K151 K151FC	302015802 K204 K204A K204FC	302015803 K207 K207A	302015801 K208 K208A	3900-2010-003 K151 K151FC	3900-2010-000 K204 K204A K204FC K406 K208 K406A K406FC K303 K408 K303A K408A K303FC K408FC K304 K483 K304A K483A K304FC K483FC K306A K484A K306FC K484FC K403 K486 K403A K486A K403FC K486FC K404		3900-2010-001 K207 K207A K307 K307A K487 K487A K487FC K157A K407A	3900-2002-518 K4043 K4043A K4083 K4083A K4083FC K4843 K4843A K488 K4883 K488A K4883A K488FC K4883FC	490030103 ALL MODELS
302012819 K303 K303A K303FC	302012820 K306 K306A K306FC	302012809 K304 K304A K304FC	302012806 K307 K307A	302012808 K404 K404A K404FC	302012807 K408 K408A K408FC	302012822 K406 K406A K406FC	302012823 K483 K483A K483FC	302012810 K484 K484A K484FC	1802-2075-803 K4843 K4843A
302012821 K403 K403A K403FC	1802-2075-802 K4043 K4043A	1802-2075-800 K4083 K4083A K4083FC	302012807 K408 K408A K408FC	1802-2075-803 K4843 K4843A		302012824 K486 K486A K486FC	302012811 K487 K487A K487FC	1802-2075-801 K488 K4883 K488A K4883A K488FC K4883FC	302015806 K157A
THERMOSTAT 			TRANSFORMER 			RELAY 		VFK-F 	
410168002 K4043 K4043A K4843 K4843A	5813-2027-000 K204 K204A K204FC K208 K208A K303 K303A K303FC K304 K304A K304FC K306 K306A K306FC K403 K403A K403FC K404 K404A		490015017 K303 K403 K483 K303A K403A K483A K303FC K403FC K483FC	490015013 K306 K406 K486 K306A K406A K486A K306FC K406FC K486FC	5018-2017-000 K4043 K4043A K4843 K4843A	5018-2017-004 K4083 K4083A K4083FC K488 K4883 K488A K4883A K488FC K4883FC		VFK 	

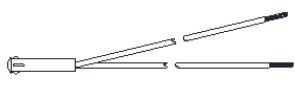
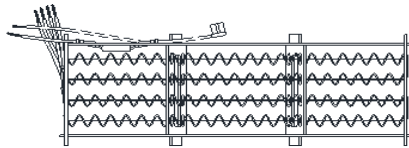
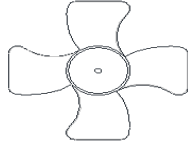
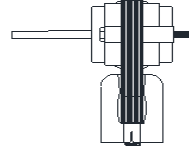

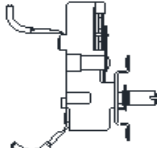
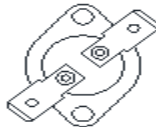



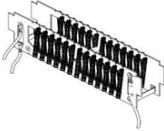
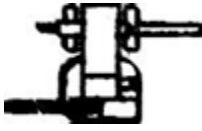
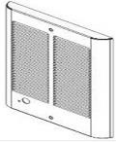

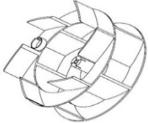

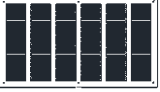
GFR SERIES								
KNOB		GRILLE			LIGHT			
								
3301-2014-004 R1500T2 R2004T2 R2404T2 R1500T2A R2004T2A R2404T2A R1500T2B R2004T2B R2404T2B	3301-11015-002 R1500T2FC R2004T2FC R2404T2FC	2501-11031-000 R1500FC R1500T2FC R2004FC R2004IFFC R2004T2FC R2404FC R2404IFFC R2404T2FC	2501-2026-000 R1500 R1500T2 R2004 R2004IF R2004T2 R2404 R2404IF R2404T2 R1500A R1500T2A R2004A R2004IFA R2004T2B R2404B R2404IFB R2404T2B		3510-2010-000 R1500 R1500T2 R1500A R1500T2A R1500B R1500T2B R1500FC R1500T2FC	3510-2010-001 R2004 R2004IF R2004T2 R2004A R2004IFA R2004T2A R2004B R2004IFB R2004T2B R2004FC R2004IFFC R2004T2FC		R2404 R2404IF R2404T2 R2404A R2404IFA R2404T2A R2404B R2404IFB R2404T2B R2404FC R2404IFFC R2404T2FC
BLOWER ASM. 				ELEMENT 			CLIP N FIT BOARD 	
1225-2000-000 R1500 R1500T2 R1500A R1500T2A R1500B R1500T2B R1500FC R1500T2FC	1225-2002-001 R2404A R2404IFA R2404T2A R2404B R2404IFB R2404T2B R2404FC R2404IFFC R2404T2FC	1225-2000-001 R2004 R2004IF R2004T2 R2404 R2404IF R2404T2 R2004A R2004IFA R2004T2A		302023802 R1500 R1500T2 R1500A R1500T2A R1500B R1500T2B R1500FC R1500T2FC	302023805 R2004 R2004IF R2004T2 R2004A R2004IFA R2004T2A R2004B R2004IFB R2004T2B R2004FC R2004IFFC R2004T2FC	302023809 R2404 R2404IF R2404T2 R2404A R2404IFA R2404T2A R2404B R2404IFB R2404T2B R2404FC R2404IFFC R2404T2FC	1249-2005-000 ALL MODELS	
THERMOSTAT 	TEMPERATURE REGULATOR 			HI-LIMIT 				
410130001 R1500T2 R2004T2 R2404T2 R1500T2A R2004T2A R2404T2A R1500T2B R2004T2B R2404T2B R1500T2FC R2004T2FC R2404T2FC	410143000 R1500 R1500T2 R2004 R2004IF R2004T2 R1500A R1500T2A R2004A R2004IFA R2004T2A		4520-2029-000 R2404 R2404IF R2404T2 R2404A R2404IFA R2404T2A R2404B R2404IFB R2404T2B R2404FC R2404IFFC R2404T2FC	4520-2025-000 R1500 R1500T2 R2004 R2004IF R2004T2 R1500A R1500T2A R2004A R2004IFA R2004T2A	4520-2025-001 R2404 R2404IF R2404T2 R2404A R2404IFA R2404T2A	4520-11010-000 R1500B R1500T2B R1500FC R1500T2FC	4520-11010-001 R2004B R2004IFB R2004T2B R2004FC R2004IFFC R2004T2FC R2404B R2404IFB R2404T2B R2404FC R2404IFFC R2404T2FC	

QFG-SERIES									
KNOB	GRILLE	BLOWER ASM				CLIP N FIT BOARD		THERMOSTAT	
									
3301-2040-001 G1512T2M G2024T2M G1512T2MA G2024T2MA G2224T2MA G1512T2MB G2024T2MB G2224T2MB G1512T2MC G2024T2MC G2224T2MC	2501-2046-000 ALL MODELS	1225-2000-000 G1012IF G1512IF G1512M G1512T2M G1512IFMA G1512MA G1512T2MA G1512IFMB G1512MB G1512T2MB G1512IFMC G1512T2MC	1225-2000-001 G1024IF G1524IF G2024IF G2024M G2024T2M G2028IF G2224IF G2024IFMA G2024MA G2024T2MA G2028IFA G2224IFMA G2224MA	1225-2002-001 G2224T2MA G2024IFMB G2024MB G2024T2MB G2028IFB G2024IFMC G2024T2MC	1225-2002-001 G2224IFMB G2224T2MB G2228IFB G2224IFC G2224T2MC G2228IFC	1249-2005-000 G1512M G1512T2M G2024M G2024T2M G2224M G1512MA G1512T2MA G2024IFMA G2024MA G2024T2MA G2224IFMA G2224MA G2224T2MA G1512IFMB		G1512MB G1512T2MB G2024IFMB G2024MB G2024T2MB G2224IFMB G2224T2MB G1512IFMC G1512T2MC G2024IFMC G2024T2MC G2224IFC G2224T2MC G2228IFC	410130001 G1512T2M G1512T2MA G1512T2MB G2024T2M G2024T2MA G2224T2MA G2024T2MB G2224T2MB G1512T2MC G2024T2MC G2224T2MC
ELEMENT		HI LIMIT				LIGHT			
									
1802-2124-005 G1024IF G2024IF	1802-2124-000 G1512IF G1512IFMA	4520-11012-000 G1512IFMC G1512T2MC	4520-11012-001 G2024IFMC G2024T2MC G2224IFC G2224T2MC	4520-2059-000 G1012IF G1512IF G1512M G1512T2M G1512IFMA G1512MA G1512T2MA G1512IFMB G1512MB G1512T2MB G1024IF G1524IF G2024M G2024T2M G2024IFMB G1524IF G2024M G2024T2M G2228IFB		3510-2017-000 G1012IF G1512IF G1512M G1512T2M G1512IFMA G1512MA G1512T2MA G1512IFMB G1512MB G1512T2MB G1512IFMC G1512T2MC	3510-2017-001 G1024IF G1524IF G2024IF G2024M G2024T2M G2028IF G2224IF G2224M G2024IFMA G2024MA G2024T2MA G2028IFA G2224IFMA G2224MA G2024T2MC G2224IFC G2224T2MC G2228IFC	G2024IFMB G2024MB G2024T2MB G2028IFB G2224IFMB G2224T2MB G2228IFB G2024IFMC G2024T2MC G2224IFC G2224T2MC G2228IFC	
1802-2125-000 G1512IFMB G1512MB G1512T2MB G1512IFMC G1512T2MC	1802-2125-002 G2024IFMB G2024MB G2024T2MB G2024IFMC G2024T2MC	 Patented Clip-N-Fit® feature (US Patented No. 6,172,343)		G1512MA G2024T2MA G2028IFA G2224IFMA G2224MA G2224T2MA G2024IFMB G2024M G2024T2M G2224IFB		G2024IFMB G2024MB G2024T2MB G2224IFB G2224T2MC G2224IFC G2224T2MC G2228IFC			
1802-2124-001 G2028IFB	1802-2125-001 G2224IFMB			G1512T2MA G1512IFMB G1512MB G1512T2MB G1024IF G1524IF G2024M G2024T2M G2228IFB		G2024IFMA G2028IFA G2224IFMA G2224MA G2224T2MA G2024IFMB G2024M G2024T2M G2224IFB			
1802-2125-006 G2228IFB G2228IFC	G2224T2MB G2224IFC G2224T2MC			G2024IFMB G2024M G2024T2M G2228IFB		G2024IFMA G2024MA G2024T2MA G2028IFA G2224IFMA G2224MA G2024T2MC G2224IFC G2224T2MC			
MODELS NOT LISTED ELEMENTS ARE OBSOLETE									

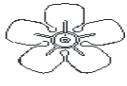

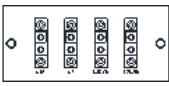
SED SERIES					
KNOB		GRILLE		LIGHT	
					
3301-2044-001 D1012C D1024C D1012CA D1024CA	3301-2039-002 D1012W D1512 D2024 D1012WA D1024WA D1512A D2024A	2501-2054-001 D1012C D1024C D1512CR D1012CA D1024CA D1512CRA	2501-2054-000 D1012W D1512 D2024 D1012WA D1024WA D1512A D2024A	3510-2017-002 D1012C D1012W D1512 D1512CR D1012CA D1012WA D1512A D1512CRA	3510-2017-003 D1024C D2024 D1024CA D1024WA D2024A
ELEMENT			FAN BLADE	MOTOR	
					
1802-2124-003 D1012C D1012W D1012CA D1012WA	1802-2124-005 D1024C D2024 D1024CA D1024WA D2024A	1802-2124-000 D1512 D1512CR D1512A D1512CRA	1210-2008-000 ALL MODELS	3900-2037-000 D1012C D1012W D1512 D1512CR D1012CA D1012WA D1512A D1512CRA	3900-2037-001 D1024C D2024 D1024CA D1024WA D2024A
THERMOSTAT		LIMIT			
					
410130001 D1012C D1012W D1512 D1012CA D1012WA D1512A D1024C D2024		4520-2055-000 D1012C D1012W D1512 D1512CR D1024C D2024	4520-11009-000 D1012CA D1012WA D1512A D1512CRA	4520-11009-001 D1024CA D1024WA D2024A	







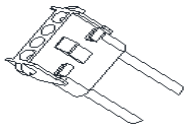
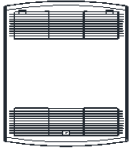
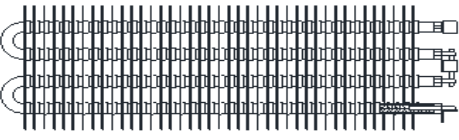
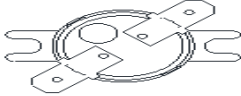

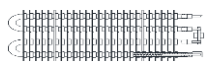

COZ-E WALL HEATER



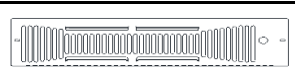
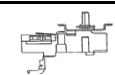

ELEMENT (INCLUDES LIMIT & ONE SHOT FUSE)		MOTOR		GRILLE
				
1802-11014-016 CZ1012IF	1802-11014-010 CZ1512T	3900-11032-000 CZ1012IF CZ1012T CZ1512IF CZ1512T	3900-11032-001 CZ1048IF CZ1048T CZ1548IF CZ1548T CZ2048IF CZ2048T	2501-11024-000 ALL MODELS
1802-11014-011 CZ1012T	1802-11014-018 CZ1548IF			
1802-11014-019 CZ1048IF	1802-11014-013 CZ1548T			
1802-11014-014 CZ1048T	1802-11014-017 CZ2048IF			
1802-11014-015 CZ1512IF	1802-11014-012 CZ2048T			
THERMOSTAT	FAN IMPELLER	PARTS KIT		
		PICTURE NOT AVAILABLE		
5813-2090-000 CZ1012T CZ1048T CZ1512T CZ1548T CZ2048T	2002-11004-000 ALL MODELS	1205-11028-501 CZ1012IF CZ1048IF CZ1512IF CZ1548IF CZ2048IF	1205-11028-500 CZ1012T CZ1048T CZ1512T CZ1548T CZ2048T	





MFQ-SERIES						
GRILLE	ELEMENTS (2 REQ)			MOTOR (2 REQ)		
						
2501-2027-000 ALL MODELS	302012819 Q6003	302012821 Q8003	302012809 Q6004 Q8007	3900-2010-000 Q6003 Q6004 Q60048 Q6006 Q6008 Q8003 Q8004 Q80048 Q8006 Q8008	3900-2010-001 Q6007 Q8007	
	302012820 Q6006 Q8006	302012826 Q80048	302012806 Q6007			
	302012825 Q60048	302012808 Q6008 Q8004	302012807 Q8008			
THERMOSTAT	FAN BLADE (2 REQ)	DISCONNECT SW.	TERMINAL BOARD			
						
410168002 (2REQ.) Q6003 Q60048 Q6006 Q8003 Q80048 Q8006	5813-0023-000 Q6004 Q6007 Q6008 Q8004 Q8007 Q8008	490030103 ALL MODELS	5216-2025-000 ALL MODELS	5823-2002-000 ALL MODELS		
TRANSFORMER			FAN DELAY (2 REQ)	MANUAL LIMIT (2 REQ)		
						
490015017 Q6003 Q8003	490015022 Q60048 Q80048	490015013 Q6006 Q8006	410074000 ALL MODELS	4520-2027-000 ALL MODELS		

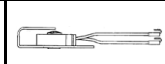
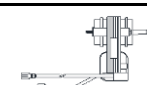
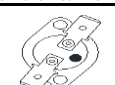
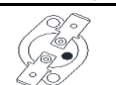









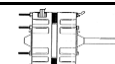

ECP SERIES (OBSOLETE)				
PLUG ASSY FEMALE	GRILLE	ELEMENT		LIMIT
				
1016-0114-000 ALL MODELS	2501-2082-000 ALL MODELS	302012808 ECP1024	302012803 ECP1524	4520-2025-001 ALL MODELS
				

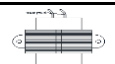

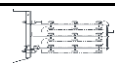







QTS SERIES							
ELEMENTS		MOTOR ASSEMBLY		HI-LIMIT	SELF HOLD LIMIT	FAN DELAY	
							
302023811 S1100 S1100A S1100B S1100C S1100CNW	302023803 S1104 S1104A S1104B S1104C S1104CNW	1225-2002-000 S1100 S1100A S1100B S1100C S1100CNW	1225-2002-001 S1104 S1104A S1104B S1104C S1104CNW	4520-2031-000 S1100 S1100A S1100B S1104 S1104A S1104B S1500 S1504 S1500A S1500B S1500C S1500T S1500TA S1500TB S1500TC S1500TCNW	4520-11011-000 S1100C S1100CNW S1500C S1500TC S1500TCNW	1414-2020-000 S1100 S1100A S1104 S1104A S1500 S1500A S1500T S1500TA S1504 S1504A S1504T	410074000 S1100B S1100C S1100CNW S1104B S1104C S1104CNW S1500B S1500C S1500TB S1500TC S1500TCNW S1504B S1504C S1504TB S1504TCNW
PILOT LIGHT		GRILLE		THERMOSTAT	KNOB	THERMAL CUTOFF	
							
3510-2010-000 S1100A S1100B S1100C S1100CNW S1500A S1500B S1500C S1500TA S1500TB S1500TC S1500TCNW	3510-2010-001 S1104 S1104A S1104B S1104C S1104CNW S1504 S1504A S1504B S1504C S1504TA S1504TB S1504TC S1504TCNW	2501-2039-000 S1100 S1100A S1100B S1100C S1104 S1104A S1104B S1104C S1500 S1500A S1500B S1500C S1500TA S1500TB	S1500TC S1504 S1504A S1504B S1504C S1504T S1504TA S1504TB S1504TC	2501-2039-001 S1100CNW S1104CNW S1500TCNW S1504TCNW	410129001 S1500T S1500TA S1500TB S1500TC S1500TCNW S1504T S1504TA S1504TB S1504TC S1504TCNW	3301-2020-006 S1500T S1500TA S1500TB S1500TC S1500TCNW S1504T S1504TA S1504TB S1504TC S1504TCNW	4520-2030-000 ALL MODELS 









FDI SERIES				
BLADE	ELEMENT		GRILLE	BUZZER
				
1210-0046-000 I1500 I1504	1802-5032-000 I1500	1802-5032-004 I1504	2501-5016-001 I1500 I1504	2714-2001-001 I1500 I1504
MOTOR	ONE SHOT FUSE BLUE DOT		HI LIMIT WHITE DOT	
				
3900-2025-000 I1500	3900-2025-001 I1504	4520-2041-000 I1500 I1504	 4520-5015-001 I1500 I1504	

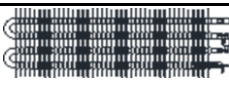
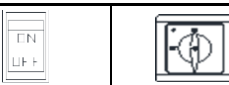

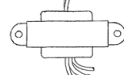





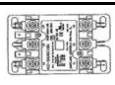

HT SERIES PUMP HOUSE HEATER			
ELEMENT	KNOB	THERMOSTAT	
			
1802-2091-000	3301-2020-006	5813-2062-000	* Neutral grey finish.

CFWF					
TOP FRONT PANEL	BOTTOM FRONT PANEL	TOP TRIM PANEL	MOTOR	RELAY	TRANSFORMER
					
1402-2312-000 CFWF920 CFWF920A	1402-2313-000 CFWF920 CFWF920A	5806-2004-000 CFWF920 CFWF920A	3900-2036-000 CFWF920 CFWF920A	5018-2017-001 CFWF920 CFWF920A	5814-0003-000 CFWF920 CFWF920A
HI-LIMIT	MANUAL RESET LIMIT	ELEMENT	FAN BLADE	PILOT LIGHT	CERAMIC LIMITS
					
4520-2053-000 CFWF920	4520-2027-000 CFWF920A	1802-2117-101 CFWF920 CFWF920A	1210-2009-001 CFWF920 CFWF920A	3510-2018-000 CFWF920 CFWF920A	4520-2052-000 CFWF920 CFWF920A

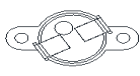

QCH (U SERIES)						
GRILLE		PLASTIC COVER (2 REQ)	ELEMENTS		MOTOR	
						
1402-2121-000 U1000 U1000A U1500 U1500A U1507 U1800 U2004 U2004A U2007 U2007A U2008	1016-11228-001 U1000FA U1500FA U2004FA U2007FA	1402-2119-000 U1000 U1000A U1500 U1500A U1507 U1800 U2004 U2004A U2007 U2007A U2008	302023812 U1000 U1000A U1000FA	302023803 U1507 302023808 U1800	490062001 U1000 U1000A U1000FA U1500 U1500A U1800	490062003 U2004 U2004A U2004FA
			302023802 U1500 U1500A U1500FA	302023806 U2007 U2007A U2007FA		490062004 U2007 U2007A U2007FA
			302023805 U2004 U2007A U2004FA	302023804 U2008	490062004 U1507	490062002 U2008
LIGHT		FAND DELAY	HI-LIMIT	FAND BLADE	DISCONNECT SW	
						
3510-2008-003 U1000A U1000FA U1500A U1500FA	3510-2008-002 U2004A U2004FA U2007A U2007FA	410074000 ALL MODELS	410143000 ALL MODELS	490061001 ALL MODELS	410170001 ALL MODELS	

QFF (F SERIES)						
MOTOR		ELEMENT			DISCONNECT	
						
3900-2002-520 F1500	3900-2002-500 F2004 F2008 F3003 F3006 F4003 F4004 F4006 F4008	302012827 F1500	302012821 F4003	302012811 F4807	410170001 F1500 F1507 F2004 F2007 F2008 F3007 F4004 F4007 F4008 F40083 F4804 F4807	5216-2019-000 F3003 F3006 F4003 F40043 F4006 F40083 F4803 F48043 F4806 F4808 F48083 F48483 F48483LV
3900-2002-501 F1507 F2007 F3007 F4007 F4807	F3003 F3006 F4003 F4004 F4006 F4008	302015806 F1507	302012808 F4004	1802-2075-802 F40043		
3900-2002-518 F40043 F40083 F48043 F4808 F48083	F4006 F4008 F4803 F4804 F4806	302015802 F2004	302012822 F4006	1802-2075-800 F40083		
		302015803 F2007	302012809 F4007	1802-2075-803 F48043		
		302015801 F2008	302012807 F4008	1802-2075-801 F4808 F48083		
	3900-2002-021 F48483 F48483LV	302012819 F3003	302012823 F4803	1802-2075-804 F48483 F48483LV		
		302012820 F3006	302012810 F4804			
		302012806 F3007	302012824 F4806			
POWER TR.	SECONDARY TR.	RELAY	GRILLE	HI-LIMIT	FAN DELAY	FAN BLADE
						
490015017 F3003 F4003 F4803	490065002 F48483LV	5018-2017-000 F40043 F48043 F48483	1402-2139-001 ALL MODELS	410169001 ALL MODELS	410074000 ALL MODELS	490030103 ALL MODELS
490015013 F3006 F4006 F4806		5018-2017-004 F40083 F4808 F48083				
490015022 F48483 F48483LV		5018-2017-001 F48483LV				

FFCH (500 SERIES)						
ELEMENT	MOTOR	RELAY	OUTLET GRILLE (2 REQ'D)	LOUVER GUIDES NAV W.	LOUVER GUIDES NOR W.	
						
302012802 542	302012813 552	3900-2011-000 542	2501-2020-001 NAVAJO WHITE 2501-2020-002 NORTHERN WHITE	1215-2059-000 REA (2 REQ'D) 1215-2059-001 SEA (2 REQ'D)	1215-2059-002 REA (2 REQ'D)	
302012803 547	302012814 557	548			1215-2059-003 SEA (2 REQ'D)	
302012801 548	302012812 558	558				
		3900-2011-001 547 557				
FAN DELAY	FAN BLADE	HI-LIMIT	POWER BLOCK			
						
1414-2039-000 ALL MODELS	1210-2000-000 ALL MODELS	4520-0011-000 ALL MODELS	5823-0004-000 ALL MODELS			

CUH900 SERIES













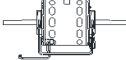















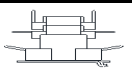
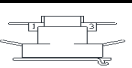

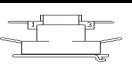
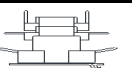

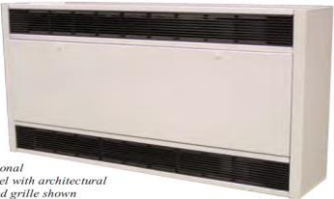

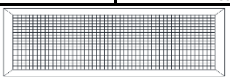
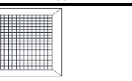



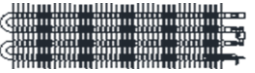
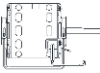

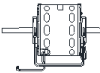

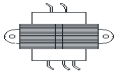

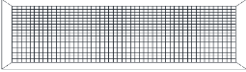
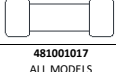
ELEMENTS

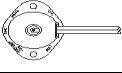
MODEL	NO. REQ.	208V	NO. REQ.	240V	NO. REQ.	277V	NO. REQ.	347V	NO. REQ.	380V	NO. REQ.	480V	NO. REQ.	600V
935														
2KW	1	1802-2083-100	1	1802-2083-101	1	1802-2083-114	1	1802-2083-103	1	1802-2083-101	1	1802-2083-114	1	1802-2083-103
3KW	1	1802-2083-107	1	1802-2083-108	1	1802-2083-116	1	1802-2083-105	1	1802-2083-108	1	1802-2083-116	1	1802-2083-105
4KW	1	1802-2083-106	1	1802-2083-107	1	1802-2083-108	1	1802-2083-109	1	1802-2083-107	1	1802-2083-118	1	1802-2083-109
5KW	1	1802-2083-110	1	1802-2083-111	1	1802-2083-120	1	1802-2083-113	1	1802-2083-111	1	1802-2083-120	1	1802-2083-113
6KW	2	1802-2083-107	2	1802-2083-108	2	1802-2083-116	2	1802-2083-105	2	1802-2083-108	2	1802-2083-116	2	1802-2083-105
7KW	1	1802-2083-106	1	1802-2083-107	1	1802-2083-118	1	1802-2083-109	1	1802-2083-107	1	1802-2083-116	1	1802-2083-109
8KW	1	1802-2083-107	1	1802-2083-108	1	1802-2083-116	1	1802-2083-105	1	1802-2083-108	1	1802-2083-116	1	1802-2083-105
	1	1802-2083-110	1	1802-2083-111	1	1802-2083-120	1	1802-2083-113	1	1802-2083-111	1	1802-2083-120	1	1802-2083-113
945														
4KW	2	1802-2083-100	2	1802-2083-101	2	1802-2083-114	2	1802-2083-103	2	1802-2083-101	2	1802-2083-114	2	1802-2083-103
6KW	2	1802-2083-107	2	1802-2083-108	2	1802-2083-116	2	1802-2083-105	2	1802-2083-108	2	1802-2083-116	2	1802-2083-105
8KW	2	1802-2083-106	2	1802-2083-107	2	1802-2083-108	2	1802-2083-109	2	1802-2083-107	2	1802-2083-118	2	1802-2083-109
10KW	2	1802-2083-110	2	1802-2083-111	2	1802-2083-120	2	1802-2083-113	2	1802-2083-111	2	1802-2083-120	2	1802-2083-113
12KW	4	1802-2083-107	4	1802-2083-108	4	1802-2083-116	4	1802-2083-105	4	1802-2083-108	4	1802-2083-116	4	1802-2083-105
14KW	2	1802-2083-106	2	1802-2083-107	2	1802-2083-116	2	1802-2083-105	2	1802-2083-107	2	1802-2083-116	2	1802-2083-105
	2	1802-2083-107	2	1802-2083-108	2	1802-2083-118	2	1802-2083-109	2	1802-2083-108	2	1802-2083-118	2	1802-2083-109
16KW	2	1802-2083-107	2	1802-2083-108	2	1802-2083-116	2	1802-2083-105	2	1802-2083-108	2	1802-2083-116	2	1802-2083-105
	2	1802-2083-110	2	1802-2083-111	2	1802-2083-120	2	1802-2083-113	2	1802-2083-111	2	1802-2083-120	2	1802-2083-113
58" AND LARGER HEATERS CONTACT FACTORY WITH CFID# ON UNIT'S NAMEPLATE														

LOUVERED PANELS







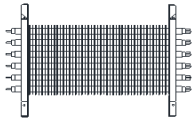
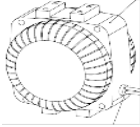

DESERT TAN	35"	4513-2114-T35	NAVAJO WHITE	35"	4513-2114-P35	NORTHERN WHITE	35"	4513-2114-W35	STAT BRONZE	35"	4513-2114-S35	
	45"	4513-2114-T45		45"	4513-2114-P45		45"	4513-2114-W45		45"	4513-2114-S45	
	58"	4513-2114-T58		58"	4513-2114-P58		58"	4513-2114-W58		58"	4513-2114-S58	
	78"	4513-2114-T78		78"	4513-2114-P78		78"	4513-2114-W78		78"	4513-2114-S78	
ALUMINUM	35"	4513-2114-A35	BLACK	35"	4513-2114-B35	CHARCOL GREY	35"	4513-2114-G35	NEUTRAL GREY	35"	4513-2114-N35	
	45"	4513-2114-A45		45"	4513-2114-B45		AR. NEUTRAL GREY	45"		4513-2114-NA45	45"	4513-2114-N45
	58"	4513-2114-A58		58"	4513-2114-B58					58"	4513-2114-N58	
			78"	4513-2114-B78			78"	4513-2114-N78				

CUH900 CONTINUED						
PRIMARY TRANSFORMER		SEC. TRANSFORMER		MOTORS		BLOWER WHEEL
						
CONTACT FACTORY WITH CFID# ON UNIT'S NAMEPLATE		490026910 MODELS WITH 24V CONTR.		CONTACT FACTORY WITH CFID# ON UNIT'S NAMEPLATE		490047001 ALL MODELS
DAMPER MOTOR	DAMPER RHEOSTAT	DAMPER RHEOSTAT KNOB	THERMOSTAT SPST	THERMOSTAT 2STG	THERMOSTAT KNOB	PLUG BUTTON
						
490050001 MODELS WITH AIR DAMPER	410104001 MODELS WITH AIR DAMPER	482084001 MODELS WITH AIR DAMPER	410127001 SINGLE STAGE MODELS	5813-2008-000 TWO STAGE MODELS	3301-2020-001 ALL MODELS	4506-2012-000 ALL MODELS
DAMPER ROCKER SW	FAN AUTO/ON SW	ON/OFF SW	HIGH/LOW SW	DOOR SAFETY SW	AUTO HIGH LIMIT	MANUAL LIMIT
						
410131001 MODELS WITH AIR DAMPER	5216-2029-001 ALL MODELS	5216-2029-001 ALL MODELS	5216-2029-000 SINGLE STAGE MODELS	5216-2028-000 ALL MODELS	4520-2048-000 ALL MODELS	4520-2017-000 ALL MODELS
FAN AUTO RELAY (120V)	FAN DELAY RELAY(120V)	POWER RELAY (120)	FAN AUTO RELAY (24V)	FAN DELAY RELAY (24V)	POWER RELAY (24)	NIGHT SETBACK RELAY
						
410101003 MODELS WITH 120V CONTROL	410171002 MODELS WITH 120V CONTROL	410101003 MODELS WITH 120V CONTROL	410101001 MODELS WITH 24V CONTROL	410171001 MODELS WITH 24V CONTROL	410101001 MODELS WITH 24V CONTROL	410101001 MODELS WITH N.S. RELAY
FUSE	FILTER	FILTER REUSABLE	DISCONNECT SW			NOTES: * TAKES TWO MOTORS ** TAKES ONE OF EACH TYPE MOTOR  <i>Optional model with architectural styled grille shown</i>
						
481001017 ALL MODELS	2010-7008-006 CU935	2010-7009-006 CU935	30 AMP	5216-2033-000		
	2010-7008-007 CU945	2010-7009-007 CU945	60 AMP	5216-2033-001		
	2010-7008-008 CU958	2010-7009-008 CU958	100 AMP	5216-2033-002		

CUH 900 SERIES STOCK MODELS						
ELEMENT		MOTOR				TIME DELAY RELAY
						
1802-2083-110 S93505203FFB S94510203FFB	1802-2083-120 S93505483FFB S94510483FFB	3900-2032-000 S93505203FFB S93505243FFB S93505483FFB S93505603FFB	3900-2033-000 S94510203FFB S94510243FFB S94510483FFB S94510603FFB	3900-2032-001 S93505271FFNC	3900-2033-001 S94510271FFNC	410101001 ALL MODELS
1802-2083-111 S93505243FFB S94510243FFB	S93505271FFNC S93505483FFB S94510271FFNC			3900-2032-001 S93505483FFNC	3900-2033-002 S94510483FFNC	FAN DELAY RELAY 
1802-2083-121 S93505603FFB S94510603FFB	S94510483FFB S94510483FFNC					410171001 ALL MODELS
PRI. TRANSFORMER		CAPACITOR		FILTER		FUSE
						
490015025 S93505483FFB S94510483FFB	490015026 S93505603FFB S94510603FFB	1432-0002-003 S93505203FFB S93505243FFB S93505483FFB S93505603FFB S94510243FFB S94510483FFB S94510603FFB	1432-0002-001 S94510203FFB	2010-7008-006 S93505203FFB S93505243FFB S93505483FFB S93505603FFB	2010-7008-007 S94510203FFB S94510243FFB S94510483FFB S94510603FFB	481001017 ALL MODELS
490026002 S93505271FFNC S94510271FFNC	5814-0003-002 S93505483FFNC S94510483FFNC					PLUG BUTTON 
SEC. TR (240/24V)	MANUAL RESET	LIMIT	HIGH/LOW SW.	DOOR SW.	FAN AUTO/ON SW.	4506-2012-000 ALL MODELS
						BLOWER WHEEL 
490026910 ALL MODELS	4520-2017-000 ALL MODELS	4520-2048-000 ALL MODELS	5216-2029-000 ALL MODELS	5216-2028-000 ALL MODELS	5216-2029-001 ALL MODELS	490047001 ALL MODELS
THERMOSTAT	T'STAT KNOB					
						
410127001 ALL MODELS	3301-2020-001 ALL MODELS					

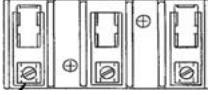

COMPACT FREEZE PROTECTION HEATERS PHFP25

ELEMENT	MOTOR	FAN BLADE	FAN RELAY	RELAY
				
1802-11002-000 PHFP25	3900-11007-000 PHFP25	1210-2017-000 PHFP25	410171003 PHFP25	1414-2038-000 PHFP25
THERMOSTAT	KNOB	HI LIMIT	POWER BLOCK	MT. BRACKET
				
5813-2091-000 PHFP25	3301-2053-000 PHFP25	1414-2037-000 PHFP25	5823-0004-005 PHFP25	310876001 PHFP25

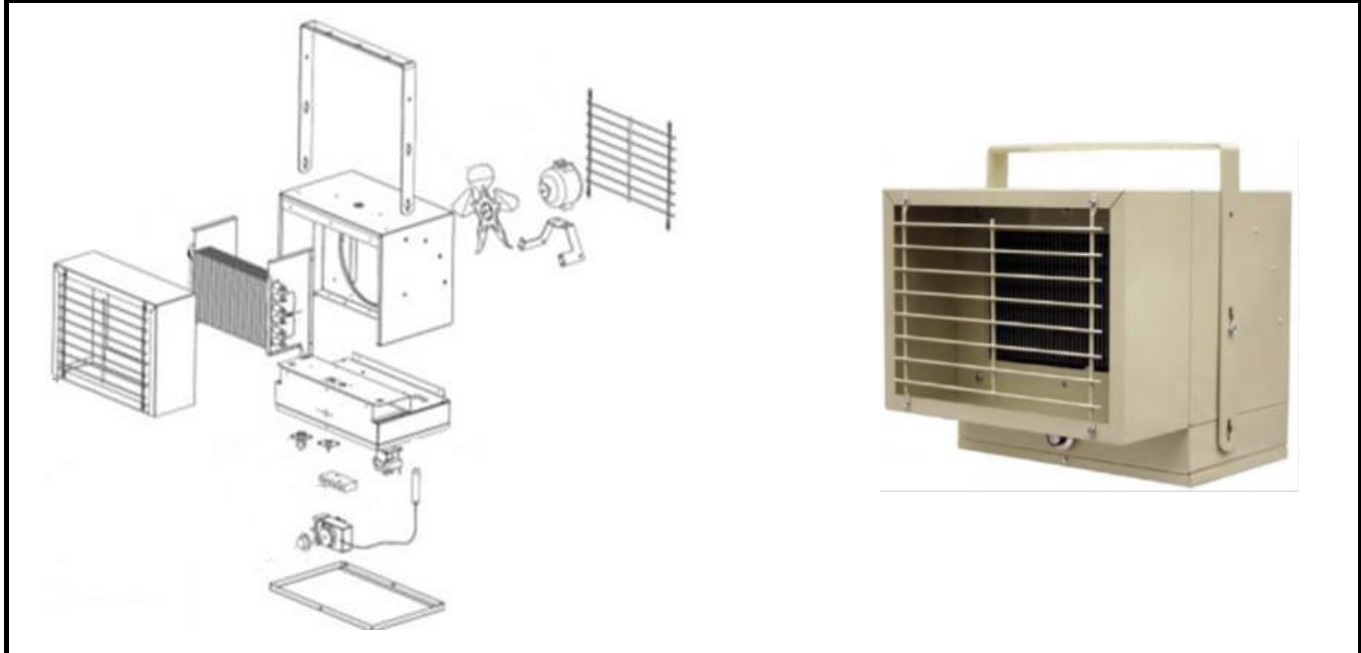









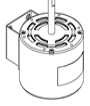
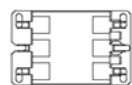
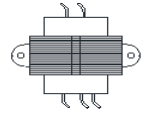

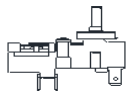
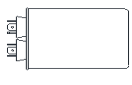
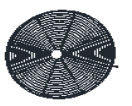
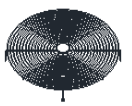

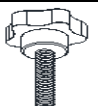

HUH SERIES

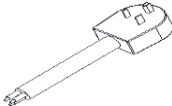
ELEMENT			FAN BLADE		MOTOR		RELAY		
302006804 UH520 UH520A	302006811 UH727 UH727A	302006842 UH1534 UH1560	1210-2017-000 UH520 UH520A UH524 UH524A	490011001 UH1020 UH1024 UH1027 UH1034 UH1048 UH1060	3900-2008-000 UH520 UH520A UH524 UH534 UH534A	490059004 UH1020 UH1024 UH1027 UH1034 UH1048 UH1060	5018-0004-102 UH520A UH524A UH538 UH538A UH548 UH548A	5018-0003-002 UH534 UH534A UH734 UH734A UH1534	5018-0005-006 UH1020 UH1024 UH1027 UH1048 UH1060 UH1520 UH1524 UH1527 UH1548 UH1560 UH2034 UH2048 UH2060 UH2548 UH2560 UH3048 UH3060
302006807 UH524 UH524A UH548 UH548A	302006840 UH734 UH734A UH760 UH760A	302006829 UH2548 302006843 UH2560 302006822 UH3048 302006844 UH3060	UH538 UH538A UH560 UH560A UH720 UH720A UH724 UH724A	UH1520 UH1524 UH1527 UH1534 UH1548 UH1560 UH1560A	UH720 UH720A UH724 UH724A UH727 UH727A UH734 UH734A	UH538 UH538A UH548 UH548A UH560 UH560A UH720 UH720A UH724 UH724A UH748 UH748A	UH1520 UH1524 UH1527 UH1534 UH1548 UH1560 UH1600 UH2034 UH2060	UH560 UH560A UH720 UH720A UH724 UH724A UH748 UH748A	UH1524 UH1527 UH1548 UH1560 UH2034 UH2048 UH2060 UH2548 UH2560 UH3048 UH3060
302006839 UH534 UH534A UH560 UH560A	302006812 UH1020 UH1527 302006813 UH1024 UH1048		UH727 UH727A UH734 UH734A UH748 UH748A UH760 UH760A	UH1527 UH1534 UH1548 UH1560	UH727 UH727A UH734 UH734A UH748 UH748A UH760 UH760A	UH560 UH560A UH720 UH720A UH724 UH724A UH748 UH748A	UH1527 UH1534 UH1548 UH1560 UH1600 UH2034 UH2060		
302006848 UH538 UH538A	UH1520 UH2048		UH720A UH724 UH727 UH727A UH734 UH734A UH748 UH748A UH760 UH760A	UH2034 UH2048 UH2060	UH2034 UH2048 UH2060 UH724A UH748 UH748A	UH2048 UH2060 UH3060	UH760A UH1034		
302006809 UH720 UH720A	302006814 UH1027 UH1524 UH1548		UH720 UH724 UH727 UH727A UH734 UH734A UH748 UH748A UH760 UH760A	UH2034 UH2048 UH2060	UH2034 UH2048 UH2060 UH724A UH748 UH748A	UH2048 UH2060 UH3060	UH760A UH1034		
302006810 UH724 UH724A UH748 UH748A	302006841 UH1034 UH1060 UH2034 UH2060		UH720 UH724 UH727 UH727A UH734 UH734A UH748 UH748A UH760 UH760A	UH2034 UH2048 UH2060	UH2034 UH2048 UH2060 UH724A UH748 UH748A	UH2048 UH2060 UH3060	UH760A UH1034		
LIGHT	FUSE BLOCK	FUSE	CAPACITOR	HI LIMIT	FAN DELAY	TRANSFORMER			
3510-2017-003 UH524A UH724A	480099002 UH1020 UH1024 UH1520 480099003 UH1520 UH1524 480096000 UH1527 480099001 UH1534 UH2034 2025-0001-000 UH2034	481001003 UH1020 UH1024 UH1520 UH1534 UH2034 481001006 UH1520 UH1524 481001023 UH1527 2019-7002-007 UH2034	1432-0002-003 UH2548 UH2560 UH3048 UH3060	410027000 ALL MODELS	410148000 ALL MODELS	490015017 UH534 UH534A UH734 UH734A 490015014 UH538 UH538A 490056001 UH548 UH548A UH748 UH748A	490015013 UH560 UH560A UH760 UH760A 490015009 UH1027 UH1527 490015019 UH1034 UH1534 UH2034	490015010 UH1048 UH1548 UH2048 490015012 UH1060 UH1560 UH2060 490015008 UH2548 UH3048 490015015 UH2560 UH3060	
QUANTITY 5 & 7.5KW (4) 10 THRU 20KW (6) 25 & 30KW (9)	LOUVER	LOUVER SPRING	HOLE PLUG	MT. BRACKET	POWER BLOCK		THERMOSTAT (ASSM INCLUDES KNOB)		
3503-2004-109 UH520 UH520A UH524 UH524A UH534 UH534A UH538 UH538A UH548 UH548A UH560 UH560A UH720 UH720A UH724 UH724A UH727 UH727A UH734 UH734A UH748 UH748A UH760 UH760A	3503-2004-111 UH1020 UH1024 UH1027 UH1034 UH1048 UH1060 UH1520 UH1524 UH1527 UH1534 UH1548 UH1560 UH2034 UH2048 UH2060	3503-2004-112 UH2548 UH2560 UH3048 UH3060	5208-7005-001 ALL MODELS	29214-11621 UH520 UH520A UH524 UH524A UH534 UH534A UH538 UH538A UH548 UH548A UH560 UH560A UH720 UH720A UH724 UH724A UH727 UH727A UH734 UH734A UH748 UH748A UH760 UH760A	310876001 UH520 UH520A UH524 UH524A UH534 UH534A UH538 UH538A UH548 UH548A UH560 UH560A UH720 UH720A UH724 UH724A UH727 UH727A UH734 UH734A UH748 UH748A UH760 UH760A	5823-0004-000 UH520 UH520A UH524 UH524A UH534 UH534A UH538 UH538A UH548 UH548A UH560 UH560A UH720 UH720A UH724 UH724A UH727 UH727A UH734 UH734A UH748 UH748A UH760 UH760A 5823-0004-005 UH734 UH734A	480100001 UH1020 UH1024 UH1027 UH1034 UH1048 UH1060 UH1520 UH1524 UH1527 UH1534 UH1548 UH1560 UH2034 UH2048 UH2060 480034002 UH2548 UH2560 UH3048 UH3060		

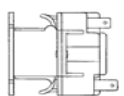

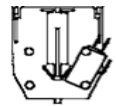
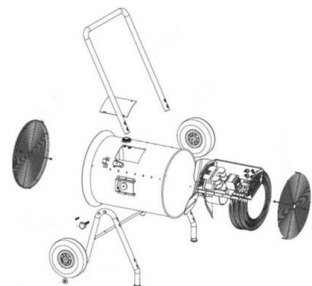
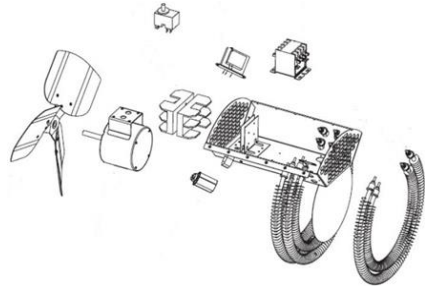
BDH SERIES

ELEMENT SMALL		ELEMENT LARGE		MOTOR		CONTACTOR		TRANSFORMER			
											
1802-11001-000 DH1583A DH1583B DH1583C		1802-11001-001 DH1583A DH1583B DH1583C		3900-11002-000 DH1021A DH1021CKA DH1021CKB DH1021CKC DH1521A DH1521B DH1521C DH1523A DH1523B DH1523C DH1543A DH1543B DH1543C DH3043A DH3043B DH3043C		5018-0006-000 DH1543A DH1543B DH1543C DH3043A DH3043B DH3043C		5018-0006-004 DH1021A DH1021CKA DH1021CKB DH1521A DH1521B DH1521C DH1523A DH1523B DH1523C DH1583A DH1583B DH1583C		5814-0003-002 DH1543A DH1543B DH1543C DH3043A DH3043B DH3043C	
1802-11001-002 DH1021A DH1021CKA DH1021CKB DH1021CKC DH1521A DH1521B DH1521C DH1523A DH1523B DH1523C DH1543A DH1543B DH1543C DH3043A DH3043B DH3043C		1802-11001-003 DH1021A DH1021CKA DH1021CKB DH1021CKC DH1521A DH1521B DH1521C DH1523A DH1523B DH1523C DH1543A DH1543B DH1543C DH3043A DH3043B DH3043C		3900-11002-001 DH1543A DH1543B DH1543C DH3043A DH3043B DH3043C		5018-0006-002 DH1021CKC					
FAN BLADE		HI LIMIT		THERMOSTAT		CAPACITOR		GUARD REAR		GUARD FRONT	
											
1210-0098-001 ALL MODELS		410029000 ALL MODELS		5813-2059-000 ALL MODELS		1432-0002-003 ALL MODELS		2504-11004-000 ALL MODELS		2504-11005-000 ALL MODELS	
HANDLE		CART KNOB		THERMOSTAT KNOB		WHEEL		SHAFT CAP		AXEL SHAFT	
											
2710-11001-000 ALL MODELS		3301-11003-000 ALL MODELS		3301-11018-002 ALL MODELS		6406-11001-000 ALL MODELS		1408-11002-000 ALL MODELS		5217-11001-000 ALL MODELS	
CORD		FUSE		FUSE BLOCK		FAN RELAY		FAN DELAY		AUXILIARY SWITCH	
											
1016-10593-000 DH1021CKA DH1021CKB SCS10063 DH1021CKC		2019-7008-077 DH1521A DH1521B DH1521C		480030007 DH1521A DH1521B DH1521C		5018-0007-000 DH1543A DH1543B DH1543C DH3043A DH3043B DH3043C		1414-2039-000 DH3043C		5216-10564-000 DH1521C DH1543A DH1543B DH1543C DH3043A DH3043B DH3043C	
											

BSDH

MODEL	ELEMENT (11)	ELEMENT (12)	MOTOR (16)	CONTACTOR (20)
SDH3043	118-304793-011 (3)	118-304793-013 (3)	193-121843-232	072-304551-008
SDH3093	118-304793-012 (3)	118-304793-014 (3)	193-121843-233	072-304551-008
SDH4843	118-304793-011 (3)	118-304793-013 (6)	193-121843-232	072-304551-008 (2)
SDH4893	118-304793-012 (3)	118-304793-014 (6)	193-121843-233	072-304551-008 (2)
SDH6043	118-304793-011 (6)	118-304793-013 (6)	193-121843-232	072-304551-008 (2)
SDH6093	118-304793-012 (6)	118-304793-014 (6)	193-121843-233	072-304551-008 (2)
MODEL	TRANSFORMER (21)	FUSE BLOCK (80)	FUSE (81)	TERM. BLOCK (84)
SDH3043	315-304252-001	NA	NA	NA*
SDH3093	315-304252-003	NA	NA	NA*
SDH4843	315-304252-001	129-025643-001	128-026510-005 (3)	303-047468-004
SDH4893	315-304252-003	129-025643-001	128-026510-005 (3)	303-047468-004
SDH6043	315-304252-001	129-025643-001 (2)	128-026510-006 (6)	303-047468-004
SDH6093	315-304252-003	129-025643-001 (2)	128-026510-006 (6)	303-047468-004

PARTS COMMON TO ALL UNITS

TEMPERATURE CONTROL (18)	300-019560-002
HI-LIMIT (19)	300-049200-004
TOGGLE SWITCH (23)	292-046123-001
BLOWER ASSEMBLY (32)	021-304823-009
INLET & OUTLET GRILLE (33)	134-304780-002 (2)
CASTER/LOCKING (36)	375-122535-007
HANDLE-RIGHT SIDE (37)	139-304779-003
HANDLE-LEFT SIDE (38)	139-304479-004
SEMPNEUMATIC WHEEL (45)	333-557518-004 (2)
PULLEY VAR. PITCH 7/8" (77)	225-305091-004
PULLEY VAR. PITCH 5/8" (78)	225-305091-003
PULLEY BELT (79)	017-049702-009
PILOT LIGHT-GREEN (86)	213-122066-043
PILOT LIGHT-AMBER (87)	213-122066-042
THERMOSTAT KNOB (94)	169-017949-004

NOTES:

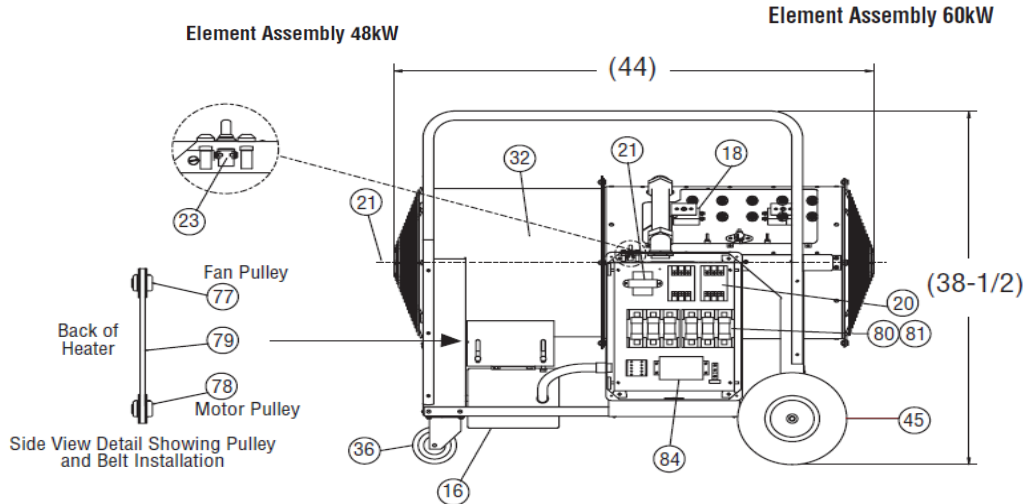
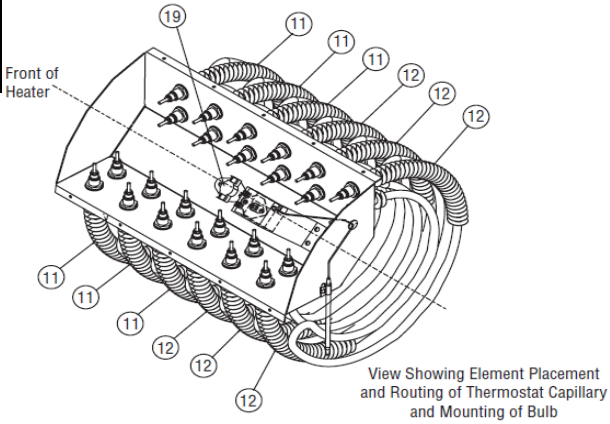
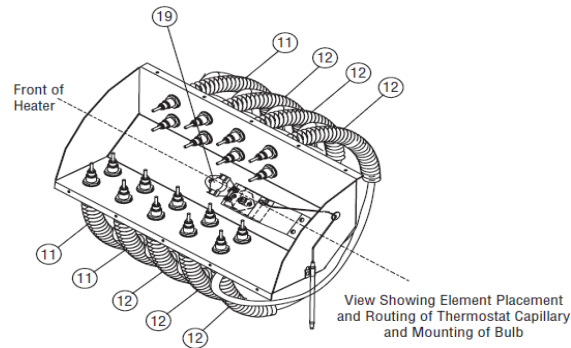
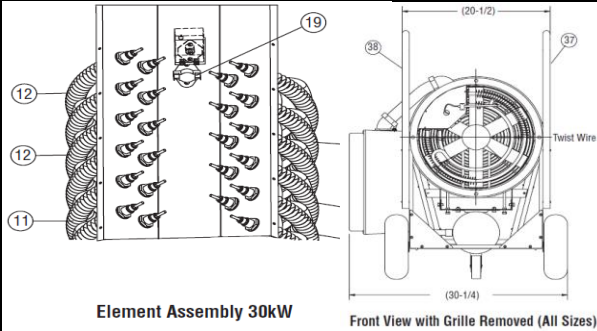

(#) QUANTITY REQ.

* WIRED DIRECTLY TO CONTACTOR



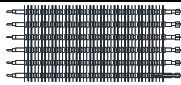
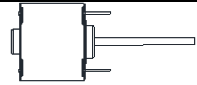
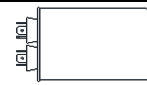



BPH PLENUM RATED UNIT HEATER

ELEMENT			MOTOR			CAPACITOR		
								
1802-10498-000 PRH1381240000 PRH1383240000	1802-10498-004 PRH11021240000 PRH11023240000 1802-10498-001 PRH1521240000 PRH1521240000 PRH1323240000 1802-10498-002 PRH1523240000 PRH121021240000 PRH21023240000 1802-10498-003 PRH11083240000 PRH1581240000 PRH1581240000 PRH1583240000 PRH1583240000 PRH21083240000	1802-10498-007 PRH1343240000 1802-10498-008 PRH11583240000 PRH17581240000 PRH17583240000 1802-10498-009 PRH17521240000 PRH17523240000 PRH17523240000 1802-10498-010 PRH17571240000 1802-10498-011 PRH11543240000 PRH17543240000 PRH21543240000	3900-10164-001 PRH11043240000 PRH11543240000 PRH1343240000 PRH1543240000 PRH17543240000 PRH21043240000 PRH21543240000	3900-10160-003 PRH11021240000 PRH11023240000 PRH11083240000 PRH11523240000 PRH1583240000 PRH1521240000 PRH1581240000 PRH1581240000 PRH1583240000 PRH17521240000 PRH17523240000 PRH17571240000 PRH17583240000 PRH21021240000 PRH21023240000 PRH21083240000 PRH21523240000	3900-2094-001 PRH1321240000 PRH1323240000 PRH1381240000 PRH1383240000 PRH1521240000 PRH1581240000 PRH1581240000 PRH1583240000 3900-2095-001 PRH171240000 PRH17521240000 PRH17523240000 PRH17581240000 PRH17583240000 PRH21021240000 PRH21023240000 PRH21083240000 PRH21523240000	1432-0002-001 PRH11043240000 PRH11071240000 PRH11543240000 PRH1321240000 PRH1323240000 PRH1343240000 PRH1371240000 PRH1381240000 PRH1383240000 PRH1521240000 PRH1523240000	1432-0002-002 PRH1543240000 PRH1571240000 PRH1581240000 PRH1583240000 PRH1583240000 PRH17543240000 PRH17571240000 PRH21043240000 PRH21071240000 PRH21543240000	PRH11021240000 PRH11023240000 PRH11083240000 PRH11523240000 PRH11583240000 PRH1321240000 PRH1323240000 PRH1343240000 PRH1371240000 PRH1381240000 PRH1383240000 PRH1521240000 PRH1523240000 PRH1543240000 PRH1571240000 PRH1581240000 PRH1581240000 PRH1583240000

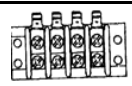
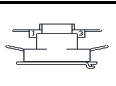
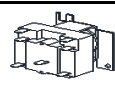



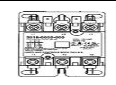

BLOWER ASSEMBLY			LIMIT			GRILLE		
								

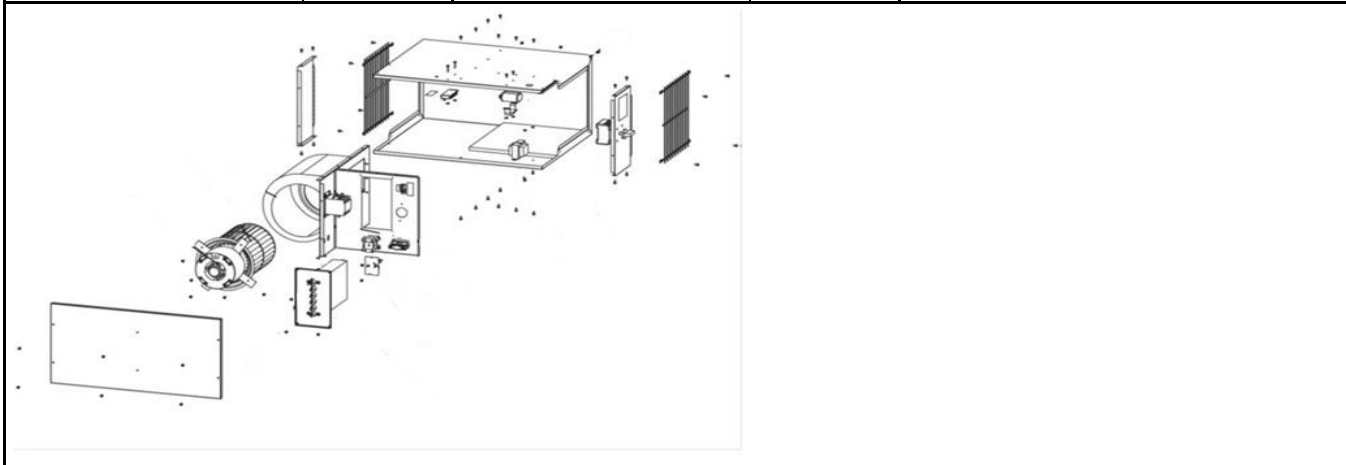
1225-10158-000 PRH11021240000 PRH11023240000 PRH11043240000 PRH1071240000 PRH11083240000 PRH11523240000 PRH11543240000 PRH1583240000 PRH1521240000 PRH1523240000 PRH1543240000 PRH1571240000 PRH1581240000 PRH1581240000 PRH1583240000	1225-2022-000 PRH1321240000 PRH1323240000 PRH1343240000 PRH17571240000 PRH1381240000 PRH1383240000 PRH1521240000 PRH1523240000 PRH1543240000 PRH1571240000 PRH1581240000 PRH1583240000	1414-2040-001 PRH11021240000 PRH11023240000 PRH11043240000 PRH1071240000 PRH11083240000 PRH11523240000 PRH11543240000 PRH1583240000 PRH1521240000 PRH1523240000 PRH1543240000 PRH1571240000 PRH1581240000 PRH1581240000 PRH21523240000 PRH21543240000	1414-2040-000 PRH1321240000 PRH1323240000 PRH1343240000 PRH1371240000 PRH1381240000 PRH1383240000 PRH1521240000 PRH1523240000 PRH1543240000 PRH1571240000 PRH1581240000 PRH1583240000	2501-10156-800 PRH11021240000 PRH11023240000 PRH11043240000 PRH1071240000 PRH11083240000 PRH11523240000 PRH11543240000 PRH1583240000 PRH1521240000 PRH1523240000 PRH1543240000 PRH1571240000 PRH1581240000 PRH1581240000 PRH21523240000 PRH21543240000	312056803 PRH1321240000 PRH1323240000 PRH1343240000 PRH1371240000 PRH1381240000 PRH1383240000 PRH1521240000 PRH1523240000 PRH1543240000 PRH1571240000 PRH1581240000
--	---	--	--	---	---





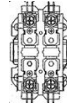

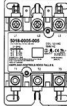
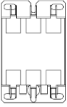
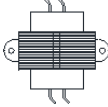



TRANSFORMER		TERMINAL BLOCK		TIME DELAY RELAY	FAN RELAY	DISCONNECT SW.
						

5814-0003-000 PRH11021240000 PRH11023240000 PRH11083240000 PRH11523240000 PRH11583240000 PRH1321240000 PRH1323240000 PRH1381240000 PRH1383240000 PRH1521240000 PRH1523240000 PRH1543240000	5814-0003-001 PRH11071240000 PRH11571240000 PRH1571240000 PRH17571240000 PRH21071240000 5814-0003-002 PRH11043240000 PRH11543240000 PRH1343240000 PRH1543240000 PRH17543240000 PRH21043240000 PRH21543240000	480106001 PRH11021240000 PRH11023240000 PRH11043240000 PRH1071240000 PRH11083240000 PRH11523240000 PRH11543240000 PRH11583240000 PRH1321240000 PRH1323240000 PRH1343240000 PRH1371240000 PRH1381240000 PRH1383240000 PRH1521240000 PRH1523240000	480106002 PRH1523240000 PRH1543240000 PRH1571240000 PRH1581240000 PRH1581240000 PRH1583240000 PRH17521240000 PRH17523240000 PRH17543240000 PRH17581240000 PRH17581240000	410171001 ALL MODELS CONTACTOR RELAY  5018-0005-004 ALL MODELS 	5018-2024-000 ALL MODELS	5216-2036-000 ALL MODELS
---	---	---	--	--	------------------------------------	------------------------------------

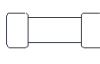











HUHAA SERIES						
ELEMENT				MOTOR		
QUANTITY OF ELEMENTS 3 THRU 10KW (3) 15 THRU 30KW (6) 40 & 50KW (9)						
						
1802-0087-024 HUHAA320FC	1802-0087-031 HUHAA720FC	1802-0087-037 HUHAA1520FC	1802-0087-018 HUHAA3024FC	3900-2002-506 HUHAA320FC	3900-0347-005 HUHAA748FC	3900-2065-000 HUHAA2548AFC
1802-0087-000 HUHAA324FC	1802-0087-006 HUHAA724FC	1802-0087-012 HUHAA1524FC	1802-0087-019 HUHAA3048AFC	3900-2002-507 HUHAA327FC	3900-0361-500 HUHAA1520FC	3900-0350-002 HUHAA5020FC
1802-0087-001 HUHAA327FC	1802-0087-007 HUHAA727FC	1802-0087-008 HUHAA1548FC	1802-0087-020 HUHAA4024FC	3900-2002-507 HUHAA524FC	3900-0361-501 HUHAA1524FC	3900-0350-000 HUHAA4024FC
1802-0087-002 HUHAA348FC	1802-0087-008 HUHAA748FC	1802-0087-026 HUHAA2020FC	1802-0087-021 HUHAA4048FC	3900-2005-000 HUHAA348FC	3900-0362-002 HUHAA2020FC	3900-0350-001 HUHAA4048FC
1802-0087-034 HUHAA520FC	1802-0087-036 HUHAA1020FC	1802-0087-016 HUHAA2524FC	1802-0087-022 HUHAA5024FC	3900-2014-004 HUHAA720FC	3900-0362-000 HUHAA2024FC	3900-0350-001 HUHAA4048FC
1802-0087-035 HUHAA524FC	1802-0087-010 HUHAA1027FC	1802-0087-017 HUHAA2548AFC	1802-0087-023 HUHAA5048FC	3900-2014-004 HUHAA724FC	3900-0362-001 HUHAA2048FC	
1802-0087-004 HUHAA527FC	1802-0087-011 HUHAA1048FC	1802-0087-028 HUHAA3020FC		3900-2014-004 HUHAA727FC	3900-0364-000 HUHAA1020FC	
1802-0087-005 HUHAA548FC	1802-0087-011 HUHAA2048FC			3900-2014-004 HUHAA1024FC	3900-0364-000 HUHAA3020FC	
				3900-2014-004 HUHAA1027FC	3900-0364-000 HUHAA3024FC	
FAN BLADE			PROTECTOR LIMIT			FAN DELAY
						
1210-2000-000 HUHAA320FC HUHAA324FC HUHAA327FC HUHAA348FC HUHAA520FC HUHAA524FC HUHAA527FC HUHAA548FC	1210-0090-000 HUHAA720FC HUHAA724FC HUHAA727FC HUHAA748FC HUHAA1020FC HUHAA1024FC HUHAA1027FC HUHAA1048FC	1210-0098-000 HUHAA2524FC HUHAA2548AFC HUHAA3020FC HUHAA3024FC HUHAA3048AFC 1210-11004-000 HUHAA4024FC HUHAA4048FC HUHAA5020FC HUHAA5024FC HUHAA5048FC	4520-0011-000 HUHAA320FC HUHAA324FC HUHAA327FC HUHAA348FC HUHAA520FC HUHAA524FC HUHAA527FC HUHAA548FC	4520-0011-001 HUHAA720FC HUHAA724FC HUHAA727FC HUHAA748FC HUHAA1020FC HUHAA1024FC HUHAA1027FC HUHAA1048FC HUHAA1520FC HUHAA1524FC HUHAA1548FC HUHAA2020FC HUHAA2024FC HUHAA2048FC	4520-0011-002 HUHAA2524FC HUHAA2548AFC HUHAA3020FC HUHAA3024FC HUHAA3048AFC HUHAA4024FC HUHAA4048FC HUHAA5020FC HUHAA5024FC HUHAA5048FC	4520-0010-000 ALL MODELS
RELAY				POWER TR		
						
5018-0003-000 HUHAA720FC HUHAA724FC HUHAA727FC HUHAA1024FC HUHAA1027FC	5018-0004-100 HUHAA348FC HUHAA548FC HUHAA748FC HUHAA1020FC HUHAA1048FC HUHAA1548FC HUHAA2048FC HUHAA4048FC HUHAA5048FC	5018-0005-004 HUHAA1520FC HUHAA1524FC HUHAA2020FC HUHAA2524FC HUHAA2548AFC HUHAA3024FC HUHAA3048AFC HUHAA4024FC HUHAA4048FC HUHAA5024FC	5018-0006-000 HUHAA2024FC HUHAA3020FC HUHAA5020FC HUHAA5048FC	5814-0003-000 HUHAA720FC HUHAA724FC HUHAA1020FC HUHAA1024FC HUHAA1520FC HUHAA1524FC HUHAA2020FC HUHAA2024FC HUHAA2524FC HUHAA3020FC HUHAA3024FC	5814-0003-002 HUHAA348FC HUHAA548FC HUHAA748FC HUHAA1048FC HUHAA1548FC HUHAA2048FC HUHAA2548AFC HUHAA3048AFC HUHAA4048FC HUHAA5048FC	490026007 HUHAA4024FC HUHAA5020FC HUHAA5024FC
				5814-0003-001 HUHAA727FC HUHAA1027FC		

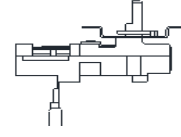
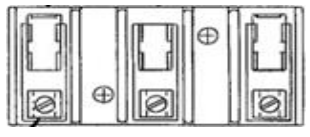
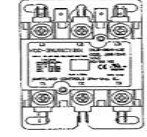
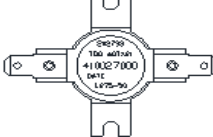
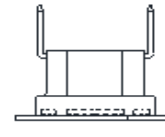









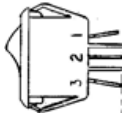

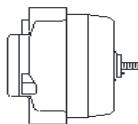
HUHAA CONTINUED

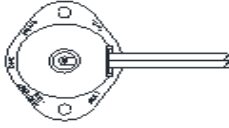
CONTROL BOARD			POWER BLOCK		FUSE BLOCK	FUSE	
							
5823-0001-000 HUHAA320FC HUHAA324FC HUHAA327FC HUHAA520FC HUHAA524FC HUHAA527FC HUHAA527FC	5823-0002-000 HUHAA348FC HUHAA548FC HUHAA724FC HUHAA727FC HUHAA748FC HUHAA1020FC HUHAA1024FC HUHAA1027FC HUHAA1048FC HUHAA1520FC HUHAA1524FC HUHAA1548FC	HUHAA2020FC HUHAA2024FC HUHAA2048FC HUHAA2524FC HUHAA2548AFC HUHAA3020FC HUHAA3024FC HUHAA3024FC HUHAA3048AFC HUHAA4024FC HUHAA4048FC HUHAA5020FC HUHAA5024FC HUHAA5048FC	5823-0004-000 HUHAA320FC HUHAA324FC HUHAA327FC HUHAA348FC HUHAA520FC HUHAA524FC HUHAA527FC HUHAA548FC HUHAA720FC	HUHAA724FC HUHAA727FC HUHAA748FC HUHAA1020FC HUHAA1024FC HUHAA1027FC HUHAA1048FC HUHAA1548FC HUHAA2048FC	5823-0004-001 HUHAA1524FC HUHAA2548AFC HUHAA3048AFC 5823-0004-002 HUHAA2020FC HUHAA2024FC HUHAA2524FC HUHAA4048FC HUHAA5048FC 5823-0004-003 HUHAA1520FC HUHAA3024FC 5823-0005-000 HUHAA3020FC HUHAA4024FC HUHAA5020FC HUHAA5024FC	2025-0002-000 HUHAA1520FC HUHAA2020FC 480030004 HUHAA2524FC HUHAA3020FC HUHAA3024FC HUHAA4024FC HUHAA5020FC HUHAA5024FC 2025-0001-000 HUHAA5048FC 2025-7004-000 HUHAA5048FC	2019-0007-010 HUHAA1520FC 2019-0007-008 HUHAA2020FC 2019-7008-077 HUHAA2524FC 2019-7008-080 HUHAA3020FC HUHAA5020FC 2019-7008-079 HUHAA3024FC HUHAA5024FC 2019-7008-078 HUHAA4024FC 2019-7002-008 HUHAA5048FC 2019-7002-012 HUHAA5048FC
LOUVERS			LOUVER SPRING	HI/LOW SW.	CAPACITOR		
QUANTITY 3&5KW (5) 7 THRU 20KW (6) 25 THRU 50KW (9)							
3503-2004-106 HUHAA320FC HUHAA324FC HUHAA327FC HUHAA348FC HUHAA520FC HUHAA524FC HUHAA527FC HUHAA548FC	3503-2004-101 HUHAA720FC HUHAA724FC HUHAA727FC HUHAA748FC HUHAA1020FC HUHAA1024FC HUHAA1027FC HUHAA1048FC HUHAA1520FC HUHAA1524FC HUHAA1548FC HUHAA2020FC HUHAA2024FC HUHAA2048FC	3503-2004-108 HUHAA2524FC HUHAA2548AFC HUHAA3020FC HUHAA3024FC HUHAA3048AFC HUHAA4024FC HUHAA4048FC HUHAA5020FC HUHAA5024FC HUHAA5048FC	5208-7005-001 ALL MODELS	5216-2053-000 HUHAA2524FC HUHAA2548AFC HUHAA3020FC HUHAA3024FC HUHAA3048AFC HUHAA4024FC HUHAA4048FC HUHAA5020FC HUHAA5024FC HUHAA5048FC	1432-0002-003 HUHAA2020FC HUHAA2024FC HUHAA2048FC HUHAA2524FC 1432-0002-001 HUHAA3020FC HUHAA2548AFC HUHAA3048AFC 1432-0002-004 HUHAA4024FC HUHAA4048FC HUHAA5020FC HUHAA5024FC HUHAA5048FC	THERMOSTAT (ASSM INCLUDES KNOB) UHMT1 (ASSEMBLY 1-POLE) 5813-0036-000 THERMOSTAT 3301-2020-006 KNOB UHMT2 (ASSEMBLY 2-STAGE) 5813-0037-000 THERMOSTAT 3301-2020-006 KNOB	



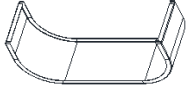
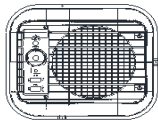
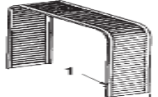
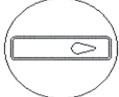

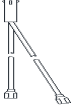

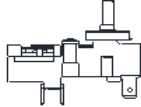



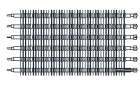

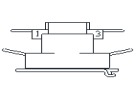

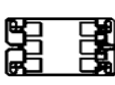
HUH524TA & HUH724ST SERIES

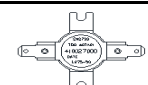
ELEMENT		MOTOR	FAN BLADE	KNOB	THERMOSTAT
					
302006807 HUH524TA HUH524TAB HUH524TAC	302006810 UH724ST UH724STA	3900-2008-000 HUH524TA HUH524TAB HUH524TAC UH724ST UH724STA	1210-2017-000 HUH524TA HUH524TAB HUH524TAC UH724ST UH724STA	3301-2014-006 HUH524TA HUH524TAB HUH524TAC UH724ST UH724STA	5813-2050-000 HUH524TA HUH524TAB HUH524TAC UH724ST UH724STA
POWER BLOCK		RELAY	HI LIMIT	FAN DELAY	LIGHT
					
5823-0004-005 HUH524TA HUH524TAB HUH524TAC	5823-0004-000 UH724ST UH724STA	5018-0004-102 UH724ST UH724STA	410027000 HUH524TA HUH524TAB HUH524TAC UH724ST UH724STA	410148000 HUH524TA HUH524TAB HUH524TAC UH724ST UH724STA	3510-2017-003 HUH524TAC UH724STA
LOUVERS		LOUVER SPRING	MT. BRACKET		
					
3503-2004-010 HUH524TA HUH524TAB HUH524TAC	UH724ST UH724STA	5208-7005-001 HUH524TA HUH524TAB HUH524TAC UH724ST UH724STA	310876001 HUH524TA HUH524TAB HUH524TAC UH724ST UH724STA		

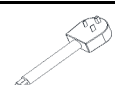
QPH4A & PH5 SERIES

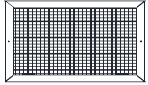

ROCKER SWITCH (2 REQ)		FAN BLADE		ELEMENT (3 REQ)		MOTOR					
											
S99814893A000 PH5 PH5HW PH5HWA PH5HWAB PH5HWAC PH5HWAD PH4A PH4AB NPH4AB NPH4ABA		1210-2000-000 PH5 PH5HW PH5HWA PH5HWAB PH5HWAC PH5HWAD PH4 PH4A		1210-2000-001 PH4AB NPH4AB NPH4ABA		1802-0087-032 PH5 PH5HW PH5HWA PH5HWAB PH5HWAC PH5HWAD	1802-0087-038 PH4 PH4A PH4AB NPH4AB NPH4ABA	3900-2002-506 PH5 PH5HW PH5HWA PH5HWAB PH5HWAC PH5HWAD PH4 PH4A PH4AB NPH4AB NPH4ABA			
FAN DELAY		MANUAL RESET		LIMIT		BUZZER					
											
4520-0010-000 PH5HWAC PH5HWAD		4520-2017-000 PH5HWA PH5HWAB PH4A		4520-11004-000 PH4AB NPH4AB		4520-11004-002 PH5HWAC PH5HWAD NPH4ABA	4520-0011-000 PH5 PH5HW PH4	2714-11001-000 PH5HWAD			
STAND		CONTROL COVER		GRILLE		GUARD		T'STAT KNOB		STAND KNOB (2 REQ)	
											
5210-2000-002 PH5HWAB PH5HWAC PH5HWAD PH4A PH4AB NPH4AB NPH4ABA		1402-0336-000 PH5 PH5HW PH5HWA PH5HWAB PH5HWAC PH5HWAD PH4 PH4AB NPH4AB NPH4ABA		1402-2154-001 PH5HWAB PH5HWAC PH5HWAD PH4AB NPH4AB NPH4ABA		2504-0011-001 PH5 PH5HW PH5HWA PH5HWAB PH5HWAC PH5HWAD PH4 PH4AB NPH4AB NPH4ABA		3301-2012-001 PH5HWAB PH5HWAC PH5HWAD PH4AB NPH4AB NPH4ABA		3301-2018-000 PH5HWA PH5HWAB PH5HWAC PH5HWAD PH4AB NPH4AB NPH4ABA	
LIGHT		CORD		THERMOSTAT							
											
3510-2007-000 PH5HWA PH5HWAB PH5HWAC PH5HWAD		1420-2028-000 PH4AB 1420-11012-000 NPH4AB NPH4ABA		5813-2018-000 PH5HWA PH5HWAB PH5HWAC PH5HWAD PH4A PH4AB NPH4AB NPH4ABA		5813-0047-000 PH5 PH5HW PH4					

TBX SERIES (OBS)

ELEMENT	MOTOR	TIME DELAY RELAY	CONTACTOR 30AMP	CONTACTOR 50AMP	THERMOSTAT
					
302006814 TBX754	490059004 ALL MODELS	410171003 ALL MODELS	5018-0003-002 ALL MODELS	5018-0006-002 ALL MODELS	5813-2059-000 ALL MODELS
302006813 TBX104					
					
490011001 ALL MODELS	410169001 ALL MODELS	480100001 ALL MODELS	1016-0193-800 ALL MODELS	1016-10593-000 ALL MODELS	3301-2053-000 ALL MODELS
					
1017-0004-000 ALL MODELS	2501-10513-800 ALL MODELS	2710-10586-000 ALL MODELS	2710-2012-800 ALL MODELS	6406-0002-000 ALL MODELS	1408-10584-000 ALL MODELS

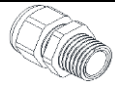

WD WASHDOWN CONTINUED

CAPACITOR				STRAIGHT FITTING	SILICONE SEAL	TERMINAL BLOCK
					PICTURE NOT AVAILABLE	
1432-0002-001		1432-0002-003		1432-0002-004		5823-2006-000
WD02112A	WD05832A	WD03712A	WD12212A	WD20432A	ALL MODELS	
WD02212A	WD07212A	WD05712A	WD12232A	WD20632A	ALL MODELS	
WD02812A	WD07232A	WD07712A	WD12432A	WD25232A		
WD03112A	WD07412A	WD10712A	WD12632A	WD25432A		
WD03212A	WD07432A		WD12812A	WD25632A		
WD03232A	WD07632A		WD12832A	WD25832A		
WD03432A	WD07812A		WD15212A	WD30232A		
WD03812A	WD07831A		WD15232A	WD30431A		
WD03832A	WD07832A		WD15412A	WD30432A		
WD05212A	WD10212A		WD15432A	WD30631A		
WD05232A	WD10232A		WD15632A	WD30632A		
WD05412A	WD10412A		WD15812A	WD30832A		
WD05431A	WD10432A		WD15832A	WD39432A		
WD05432A	WD10632A		WD20232A	WD394632A		
WD05632A	WD10832A		WD20412A			
WD05812A						

GRILLE INLET	GRILLE OUTLET
	

2504-11018-000		2504-11020-000		2504-11019-001		2504-11021-001	
WD02112A	WD05832A	WD12212A	WD20432A	WD02112A	WD05832A	WD12212A	WD20432A
WD02212A	WD07212A	WD12232A	WD20632A	WD02212A	WD07212A	WD12232A	WD20632A
WD02812A	WD07232A	WD12432A	WD25232A	WD02812A	WD07232A	WD12432A	WD25232A
WD03112A	WD07412A	WD12632A	WD25432A	WD03112A	WD07412A	WD12632A	WD25432A
WD03212A	WD07432A	WD12812A	WD25632A	WD03212A	WD07432A	WD12812A	WD25632A
WD03232A	WD07632A	WD12832A	WD25832A	WD03232A	WD07632A	WD12832A	WD25832A
WD03432A	WD07712A	WD15212A	WD30232A	WD03432A	WD07712A	WD15212A	WD30232A
WD03712A	WD07812A	WD15232A	WD30431A	WD03712A	WD07812A	WD15232A	WD30431A
WD03812A	WD07831A	WD15412A	WD30432A	WD03812A	WD07831A	WD15412A	WD30432A
WD03832A	WD07832A	WD15432A	WD30631A	WD03832A	WD07832A	WD15432A	WD30631A
WD05212A	WD10212A	WD15632A	WD30632A	WD05212A	WD10212A	WD15632A	WD30632A
WD05232A	WD10232A	WD15812A	WD30832A	WD05232A	WD10232A	WD15812A	WD30832A
WD05412A	WD10412A	WD15832A	WD39432A	WD05412A	WD10412A	WD15832A	WD39432A
WD05431A	WD10432A	WD20232A	WD394632A	WD05431A	WD10432A	WD20232A	WD394632A
WD05432A	WD10632A	WD20412A		WD05432A	WD10632A	WD20412A	
WD05632A	WD10712A			WD05632A	WD10712A		
WD05712A	WD10832A			WD05712A	WD10832A		
WD05812A				WD05812A			

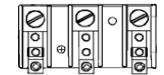
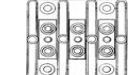
POWER BLOCK	
	

5823-0004-002		480034002	
WD02112A	WD05812A	WD12232A	WD12212A
WD02212A	WD05832A	WD12432A	WD12632A
WD02812A	WD07212A	WD12832A	WD12812A
WD03112A	WD07232A	WD15232A	WD15212A
WD03212A	WD07412A	WD15412A	WD15632A
WD03232A	WD07432A	WD15432A	WD15812A
WD03432A	WD07712A	WD15832A	WD20232A
WD03712A	WD07812A	WD20412A	WD20632A
WD03812A	WD07831A	WD20432A	WD25232A
WD03832A	WD07832A	WD25432A	WD25632A
WD05212A	WD10212A	WD30431A	WD25832A
WD05232A	WD10232A	WD30432A	WD30232A
WD05412A	WD10412A	WD39432A	WD30631A
WD05431A	WD10432A		WD30632A
WD05432A	WD10712A		WD30832A
WD05712A	WD10832A		WD394632A

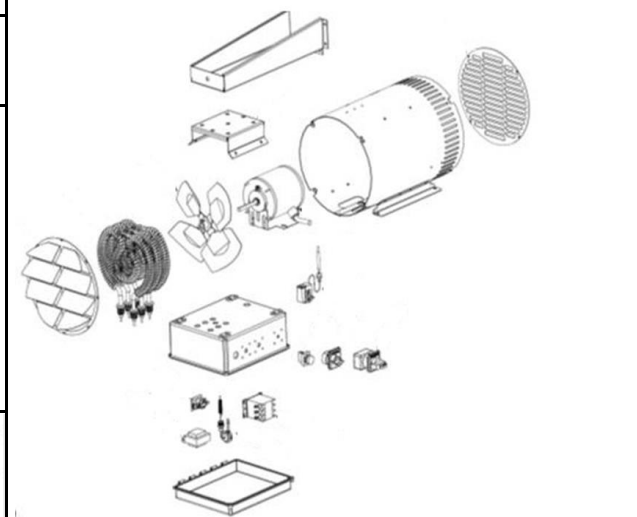







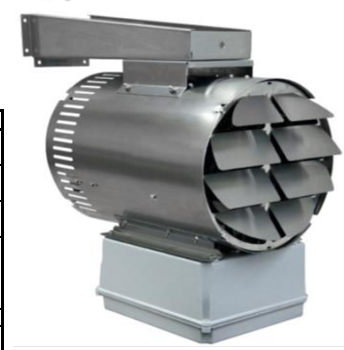

Factory Installed Accessories

CATALOG NUMBER	DESCRIPTION
T	Thermostat
L	Pilot Light
S	Mode/Selector Switch
D	Disconnect Switch
E	Monel Element*
M	Manual Reset
P	Epoxy Coating

PART	GASKET	KNOB
THERMOSTAT SM/MD UNITS LRG UNITS	5813-11010-000 5206-11009-000 5206-11010-000	3301-11010-000
PILOT LIGHT 120V CONTROL 24V CONTROL	3510-11009-001 3510-11009-000	N/A
MODE SWITCH SM/MD UNITS LRG UNITS	4529-11011-000 4529-11011-001	5206-11009-000 PART OF SW. ASSM
DISCONNECT SWITCH 40AMP 60AMP 100AMP 125AMP	5216-11017-000 5216-11017-001 5216-11017-002 5216-11017-003	5206-11009-000 PART OF SW. ASSM
MONEL ELEMENT CONTACT FACTORY		
MANUAL RESET SM/MD UNITS LRG UNITS	4520-11017-000 4520-11017-001	N/A
EPOXY COATING CONTACT FACTORY		



UCJ								
ELEMENT				LINEAR LIMIT			TR. RELAY	
								
1802-2056-003 J400B	1802-2044-011 J750B	1802-2044-014 J1007B	1802-2044-228 J1503B	4520-2018-000 J400B	4520-2018-003 J1000B	4520-2018-005 J1500B	5018-11003-003 J503B	410043007 J1006B
1802-2056-001 J404B	1802-2044-210 J753B	1802-2044-016 J1008B	1802-2044-027 J1504B	J404B	J1003B	J1503B	J753B	J1256B
1802-2056-000 J407B	1802-2044-009 J754B	1802-2044-023 J1250B	1802-2044-229 J1506B	J407B	J1004B	J1504B	J1003B	J1506B
1802-2056-002 J408B	1802-2044-008 J757B	1802-2044-222 J1253B	1802-2044-026 J1507B	J408B	J1006B	J1506B	J1253B	J2006B
1802-2044-043 J500B	1802-2044-010 J758B	1802-2044-021 J1254B	1802-2044-028 J1508B	4520-2018-001 J500B	J1007B	J1507B	J1503B	
1802-2044-202 J503B	1802-2044-017 J1000B	1802-2044-223 J1256B	1802-2044-234 J2003B	J503B	4520-2018-004 J1250B	4520-2018-006 J2003B	J2003B	
1802-2044-041 J504B	1802-2044-216 J1003B	1802-2044-020 J1257B	1802-2044-033 J2004B	J507B	J1253B	J2004B	J2004B	
1802-2044-040 J507B	1802-2044-015 J1004B	1802-2044-022 J1258B	1802-2044-235 J2006B	J508B	J1254B	J2006B	J2006B	
1802-2044-042 J508B	1802-2044-217 J1006B	1802-2044-029 J1500B	1802-2044-032 J2007B	4520-2018-002 J750B	J1256B	J2007B	J2007B	
			1802-2044-034 J2008B	J753B	J1257B	J2008B		
				J754B	J1258B			
				J757B				
				J758B				
SWITCH		FRONT COVER			CONTROL COVER	THERMOSTAT		
								
5216-11007-000 J400B J404B J407B J408B J500B J504B J507B J508B J750B J754B J757B J758B J1000B J1004B	J1007B J1008B J1250B J1254B J1257B J1258B J1500B J1504B J1507B J1508B J2004B J2007B J2008B	5216-2053-000 J503B J753B J1003B J1006B J1253B J1256B J1503B J1506B J2003B J2006B	1402-2192-006 J400B J404B J407B J408B 1402-2192-001 J500B J503B J504B J507B J508B 1402-2192-002 J750B J753B J754B J757B J758B	1402-2192-003 J1000B J1003B J1004B J1006B J1007B J1008B 1402-2192-004 J1250B J1253B J1254B J1256B J1257B J1258B	1402-2192-005 J1500B J1503B J1504B J1506B J1507B J1508B 1402-2192-007 J2003B J2004B J2006B J2007B J2008B	1402-11020-000 ALL MODELS	5813-0024-000 ALL MODELS	
								

ASL SERIES

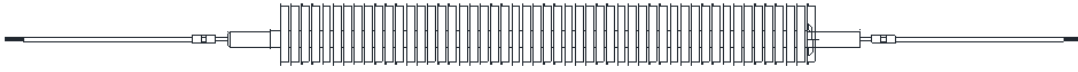

DISCRIPTION	PART NUMBERS					
	120V	208V	240V	277V	347V	600V
*ELEMENT (100 WATTS/FT)						
28" HEATER	1802-2001-047	1802-2001-048	1802-2001-049	NA	NA	NA
3'	1802-2001-053	1802-2001-054	1802-2001-055	1802-2001-056	NA	NA
4'	1802-2001-059	1802-2001-060	1802-2001-061	1802-2001-062	1802-2001-232	NA
5'	1802-2001-065	1802-2001-066	1802-2001-067	1802-2001-068	1802-2001-242	NA
6'	1802-2001-071	1802-2001-072	1802-2001-073	1802-2001-074	1802-2001-252	1802-2001-253
8'	NA	1802-2001-077	1802-2001-078	1802-2001-079	1802-2001-262	1802-2001-263
10'	NA	1802-2001-081	1802-2001-082	1802-2001-083	1802-2001-272	1802-2001-273
*ELEMENT (125 WATTS/FT)						
28" HEATER	1802-2001-085	1802-2001-086	1802-2001-048	1802-2001-049	NA	NA
3'	1802-2001-087	1802-2001-088	1802-2001-054	1802-2001-055	1802-2001-220	NA
4'	1802-2001-089	1802-2001-090	1802-2001-060	1802-2001-061	1802-2001-230	NA
5'	1802-2001-091	1802-2001-092	1802-2001-066	1802-2001-067	1802-2001-240	1802-2001-241
6'	1802-2001-093	1802-2001-094	1802-2001-072	1802-2001-073	1802-2001-250	1802-2001-251
8'	NA	1802-2001-095	1802-2001-077	1802-2001-078	1802-2001-260	1802-2001-261
10'	NA	1802-2001-096	1802-2001-081	1802-2001-082	1802-2001-270	1802-2001-271
*ELEMENT (150 WATTS/FT)						
28" HEATER	1802-2001-051	1802-2001-001	1802-2001-000	1802-2001-052	NA	NA
3'	1802-2001-057	1802-2001-007	1802-2001-006	1802-2001-058	1802-2001-218	NA
4'	1802-2001-063	1802-2001-013	1802-2001-012	1802-2001-064	1802-2001-228	NA
5'	1802-2001-069	1802-2001-019	1802-2001-018	1802-2001-070	1802-2001-238	1802-2001-239
6'	1802-2001-075	1802-2001-025	1802-2001-024	1802-2001-076	1802-2001-248	1802-2001-249
8'	NA	1802-2001-031	1802-2001-030	1802-2001-080	1802-2001-258	1802-2001-259
10'	NA	1802-2001-035	1802-2001-034	1802-2001-084	1802-2001-268	1802-2001-269
*ELEMENT (188 WATTS/FT)						
28" HEATER	1802-2001-005	1802-2001-002	1802-2001-001	1802-2001-000	NA	NA
3'	1802-2001-011	1802-2001-008	1802-2001-007	1802-2001-006	1802-2001-216	NA
4'	1802-2001-017	1802-2001-014	1802-2001-013	1802-2001-012	1802-2001-226	1802-2001-227
5'	1802-2001-023	1802-2001-020	1802-2001-019	1802-2001-018	1802-2001-236	1802-2001-237
6'	1802-2001-029	1802-2001-026	1802-2001-025	1802-2001-024	1802-2001-246	1802-2001-247
8'	NA	1802-2001-032	1802-2001-031	1802-2001-030	1802-2001-256	1802-2001-257
10'	NA	1802-2001-036	1802-2001-035	1802-2001-034	1802-2001-266	1802-2001-267
*ELEMENT (250 WATTS/FT)						
28" HEATER	1802-2001-004	1802-2001-003	1802-2001-002	1802-2001-001	1802-2001-202	NA
3'	1802-2001-010	1802-2001-009	1802-2001-008	1802-2001-007	1802-2001-214	NA
4'	1802-2001-016	1802-2001-015	1802-2001-014	1802-2001-013	1802-2001-224	1802-2001-225
5'	1802-2001-022	1802-2001-021	1802-2001-020	1802-2001-019	1802-2001-234	1802-2001-235
6'	1802-2001-028	1802-2001-027	1802-2001-026	1802-2001-025	1802-2001-244	1802-2001-245
8'	NA	1802-2001-033	1802-2001-032	1802-2001-031	1802-2001-254	1802-2001-255
10'	NA	1802-2001-037	1802-2001-036	1802-2001-035	1802-2001-264	1802-2001-265
* 1, 2 OR 3 ELEMENTS MAY BE REQUIRED. VOLTAGE AND WATTAGE ARE STAMPED ON END OF ELEMENTS. DIVIDE THE WATTAGE BY THE HEATER LENGTH (FEET) TO DETERMINE WATTS/FOOT OF ELEMENT. THEN USE THIS DATA TO DETERMINE PART NUMBER OF HEATING ELEMENT.						

DISCRIPTION	PART NUMBERS					
	120V	208V	240V	277V	347V	600V
LINEAR LIMIT						
28" HEATER	4520-0007-007	4520-0007-007	4520-0007-007	4520-0007-007	4520-0007-007	4520-0007-007
3'	4520-0007-008	4520-0007-008	4520-0007-008	4520-0007-008	4520-0007-008	4520-0007-008
4'	4520-0007-009	4520-0007-009	4520-0007-009	4520-0007-009	4520-0007-009	4520-0007-009
5'	4520-0007-010	4520-0007-010	4520-0007-010	4520-0007-010	4520-0007-010	4520-0007-010
6'	4520-0007-011	4520-0007-011	4520-0007-011	4520-0007-011	4520-0007-011	4520-0007-011
8'	NA	4520-0007-012	4520-0007-012	4520-0007-012	4520-0007-012	4520-0007-012
10'	NA	4520-0007-013	4520-0007-013	4520-0007-013	4520-0007-013	4520-0007-013
DISCONNECT SW.	THERMOSTAT	TRANSFORMER		POWER RELAY		
410170001	2-STAGE 5813-0023-000 SINGLE POLE 5813-0024-000	120V 5018-11003-000 208/240V 5018-11003-001	277V 5018-11003-002 347V 5018-11003-003	24V 5018-2006-000 120V 5018-2021-001	208/240V 5018-2006-002 277V 5018-2006-003	

BDBSL SERIES

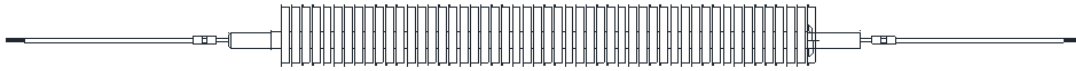





DISCRIPTION	PART NUMBERS							
	120V	208V	240V	277V	347V	600V		
*ELEMENT (100 WATTS/FT)								
28" HEATER	1802-2001-047	1802-2001-048	1802-2001-049	NA	NA	NA		
3'	1802-2001-053	1802-2001-054	1802-2001-055	1802-2001-056	NA	NA		
4'	1802-2001-059	1802-2001-060	1802-2001-061	1802-2001-062	1802-2001-232	NA		
5'	1802-2001-065	1802-2001-066	1802-2001-067	1802-2001-068	1802-2001-242	NA		
6'	1802-2001-071	1802-2001-072	1802-2001-073	1802-2001-074	1802-2001-252	1802-2001-253		
8'	NA	1802-2001-077	1802-2001-078	1802-2001-079	1802-2001-262	1802-2001-263		
10'	NA	1802-2001-081	1802-2001-082	1802-2001-083	1802-2001-272	1802-2001-273		
*ELEMENT (125 WATTS/FT)								
28" HEATER	1802-2001-085	1802-2001-086	1802-2001-048	1802-2001-049	NA	NA		
3'	1802-2001-087	1802-2001-088	1802-2001-054	1802-2001-055	1802-2001-220	NA		
4'	1802-2001-089	1802-2001-090	1802-2001-060	1802-2001-061	1802-2001-230	NA		
5'	1802-2001-091	1802-2001-092	1802-2001-066	1802-2001-067	1802-2001-240	1802-2001-241		
6'	1802-2001-093	1802-2001-094	1802-2001-072	1802-2001-073	1802-2001-250	1802-2001-251		
8'	NA	1802-2001-095	1802-2001-077	1802-2001-078	1802-2001-260	1802-2001-261		
10'	NA	1802-2001-096	1802-2001-081	1802-2001-082	1802-2001-270	1802-2001-271		
*ELEMENT (150 WATTS/FT)								
28" HEATER	1802-2001-051	1802-2001-001	1802-2001-000	1802-2001-052	NA	NA		
3'	1802-2001-057	1802-2001-007	1802-2001-006	1802-2001-058	1802-2001-218	NA		
4'	1802-2001-063	1802-2001-013	1802-2001-012	1802-2001-064	1802-2001-228	NA		
5'	1802-2001-069	1802-2001-019	1802-2001-018	1802-2001-070	1802-2001-238	1802-2001-239		
6'	1802-2001-075	1802-2001-025	1802-2001-024	1802-2001-076	1802-2001-248	1802-2001-249		
8'	NA	1802-2001-031	1802-2001-030	1802-2001-080	1802-2001-258	1802-2001-259		
10'	NA	1802-2001-035	1802-2001-034	1802-2001-084	1802-2001-268	1802-2001-269		
*ELEMENT (188 WATTS/FT)								
24" HEATER	1802-2001-038	1802-2001-039	1802-2001-040	1802-2001-041	1802-2001-200	NA		
28"	1802-2001-005	1802-2001-002	1802-2001-001	1802-2001-000	NA	NA		
3'	1802-2001-011	1802-2001-008	1802-2001-007	1802-2001-006	1802-2001-216	NA		
4'	1802-2001-017	1802-2001-014	1802-2001-013	1802-2001-012	1802-2001-226	1802-2001-227		
5'	1802-2001-023	1802-2001-020	1802-2001-019	1802-2001-018	1802-2001-236	1802-2001-237		
6'	1802-2001-029	1802-2001-026	1802-2001-025	1802-2001-024	1802-2001-246	1802-2001-247		
8'	NA	1802-2001-032	1802-2001-031	1802-2001-030	1802-2001-256	1802-2001-257		
10'	NA	1802-2001-036	1802-2001-035	1802-2001-034	1802-2001-266	1802-2001-267		
LINEAR LIMIT		DISCONNECT SW.	THERMOSTAT					
28" HEATER	4520-0007-007	410170001	2-STAGE				SINGLE POLE	
3'	4520-0007-008		5813-0023-000				410129002	
4'	4520-0007-009							
5'	4520-0007-010							
6'	4520-0007-011							
8'	4520-0007-012							
10'	4520-0007-013							

ICST SERIES



DISCRPTION	PART NUMBERS					
	120V	208V	240V	277V	347V	600V
*ELEMENT (125 WATTS/FT)						
28" HEATER	1802-2001-085	1802-2001-086	1802-2001-048	1802-2001-049	NA	NA
3'	1802-2001-087	1802-2001-088	1802-2001-054	1802-2001-055	1802-2001-220	NA
4'	1802-2001-089	1802-2001-090	1802-2001-060	1802-2001-061	1802-2001-230	NA
5'	1802-2001-091	1802-2001-092	1802-2001-066	1802-2001-067	1802-2001-240	1802-2001-241
6'	1802-2001-093	1802-2001-094	1802-2001-072	1802-2001-073	1802-2001-250	1802-2001-251
8'	NA	1802-2001-095	1802-2001-077	1802-2001-078	1802-2001-260	1802-2001-261
10'	NA	1802-2001-096	1802-2001-081	1802-2001-082	1802-2001-270	1802-2001-271
*ELEMENT (188 WATTS/FT)						
28" HEATER	1802-2001-005	1802-2001-002	1802-2001-001	1802-2001-000	NA	NA
3'	1802-2001-011	1802-2001-008	1802-2001-007	1802-2001-006	1802-2001-216	NA
4'	1802-2001-017	1802-2001-014	1802-2001-013	1802-2001-012	1802-2001-226	1802-2001-227
5'	1802-2001-023	1802-2001-020	1802-2001-019	1802-2001-018	1802-2001-236	1802-2001-237
6'	1802-2001-029	1802-2001-026	1802-2001-025	1802-2001-024	1802-2001-246	1802-2001-247
8'	NA	1802-2001-032	1802-2001-031	1802-2001-030	1802-2001-256	1802-2001-257
10'	NA	1802-2001-036	1802-2001-035	1802-2001-034	1802-2001-266	1802-2001-267
*ELEMENT (250 WATTS/FT)						
28" HEATER	1802-2001-004	1802-2001-003	1802-2001-002	1802-2001-001	1802-2001-202	NA
3'	1802-2001-010	1802-2001-009	1802-2001-008	1802-2001-007	1802-2001-214	NA
4'	1802-2001-016	1802-2001-015	1802-2001-014	1802-2001-013	1802-2001-224	1802-2001-225
5'	1802-2001-022	1802-2001-021	1802-2001-020	1802-2001-019	1802-2001-234	1802-2001-235
6'	1802-2001-028	1802-2001-027	1802-2001-026	1802-2001-025	1802-2001-244	1802-2001-245
8'	NA	1802-2001-033	1802-2001-032	1802-2001-031	1802-2001-254	1802-2001-255
10'	NA	1802-2001-037	1802-2001-036	1802-2001-035	1802-2001-264	1802-2001-265

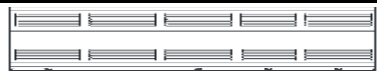

DISCRPTION	PART NUMBERS					
	120V	208V	240V	277V	347V	600V
LINEAR LIMIT						
28" HEATER	4520-2018-001	4520-2018-001	4520-2018-001	4520-2018-001	4520-2018-001	4520-2018-001
3'	4520-2018-002	4520-2018-002	4520-2018-002	4520-2018-002	4520-2018-002	4520-2018-002
4'	4520-2018-003	4520-2018-003	4520-2018-003	4520-2018-003	4520-2018-003	4520-2018-003
5'	4520-2018-004	4520-2018-004	4520-2018-004	4520-2018-004	4520-2018-004	4520-2018-004
6'	4520-2018-005	4520-2018-005	4520-2018-005	4520-2018-005	4520-2018-005	4520-2018-005
8'	NA	4520-2018-006	4520-2018-006	4520-2018-006	4520-2018-006	4520-2018-006
10'	NA	4520-2018-007	4520-2018-007	4520-2018-007	4520-2018-007	4520-2018-007
DISCONNECT SW.	THERMOSTAT	TRANSFORMER RELAY		J-BOX COVER	FRONT COVER	
						
DS	2-STAGE 5813-0023-000 SINGLE POLE 5813-0024-000	120V 5018-11003-000 208/240V 5018-11003-001	277V 5018-11003-002 347V 5018-11003-003	ALL MODELS 1402-2250-000	1402-2251-000 1402-2251-001 1402-2251-002 1402-2251-003 1402-2251-004 1402-2251-005 1402-2251-006	28" 3' 4' 5' 6' 8' 10'

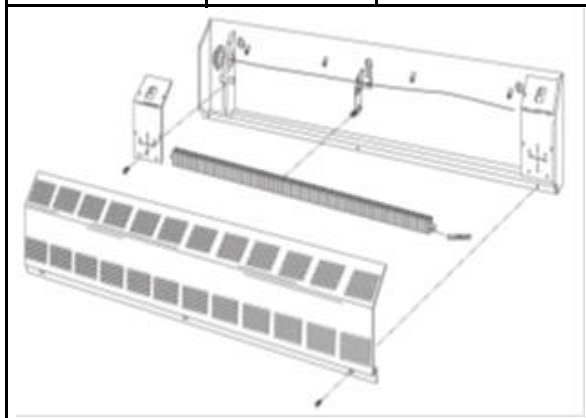

CSL & CPL SERIES

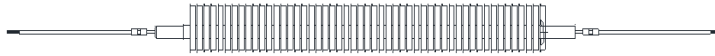

DISCRIPTION	PART NUMBERS					
	120V	208V	240V	277V	347V	600V
*ELEMENT (125 WATTS/FT)						
28" HEATER	1802-2001-085	1802-2001-086	1802-2001-048	1802-2001-049	NA	NA
3'	1802-2001-087	1802-2001-088	1802-2001-054	1802-2001-055	1802-2001-220	NA
4'	1802-2001-089	1802-2001-090	1802-2001-060	1802-2001-061	1802-2001-230	NA
5'	1802-2001-091	1802-2001-092	1802-2001-066	1802-2001-067	1802-2001-240	1802-2001-241
6'	1802-2001-093	1802-2001-094	1802-2001-072	1802-2001-073	1802-2001-250	1802-2001-251
8'	NA	1802-2001-095	1802-2001-077	1802-2001-078	1802-2001-260	1802-2001-261
10'	NA	1802-2001-096	1802-2001-081	1802-2001-082	1802-2001-270	1802-2001-271
*ELEMENT (188 WATTS/FT)						
28" HEATER	1802-2001-005	1802-2001-002	1802-2001-001	1802-2001-000	NA	NA
3'	1802-2001-011	1802-2001-008	1802-2001-007	1802-2001-006	1802-2001-216	NA
4'	1802-2001-017	1802-2001-014	1802-2001-013	1802-2001-012	1802-2001-226	1802-2001-227
5'	1802-2001-023	1802-2001-020	1802-2001-019	1802-2001-018	1802-2001-236	1802-2001-237
6'	1802-2001-029	1802-2001-026	1802-2001-025	1802-2001-024	1802-2001-246	1802-2001-247
8'	NA	1802-2001-032	1802-2001-031	1802-2001-030	1802-2001-256	1802-2001-257
10'	NA	1802-2001-036	1802-2001-035	1802-2001-034	1802-2001-266	1802-2001-267
*ELEMENT (250 WATTS/FT)						
28" HEATER	1802-2001-004	1802-2001-003	1802-2001-002	1802-2001-001	1802-2001-202	NA
3'	1802-2001-010	1802-2001-009	1802-2001-008	1802-2001-007	1802-2001-214	NA
4'	1802-2001-016	1802-2001-015	1802-2001-014	1802-2001-013	1802-2001-224	1802-2001-225
5'	1802-2001-022	1802-2001-021	1802-2001-020	1802-2001-019	1802-2001-234	1802-2001-235
6'	1802-2001-028	1802-2001-027	1802-2001-026	1802-2001-025	1802-2001-244	1802-2001-245
8'	NA	1802-2001-033	1802-2001-032	1802-2001-031	1802-2001-254	1802-2001-255
10'	NA	1802-2001-037	1802-2001-036	1802-2001-035	1802-2001-264	1802-2001-265

* 1, 2 OR 3 ELEMENTS MAY BE REQUIRED. VOLTAGE AND WATTAGE ARE STAMPED ON END OF ELEMENTS. DIVIDE THE WATTAGE BY THE HEATER LENGTH (FEET) TO DETERMINE WATTS/FOOT OF ELEMENT. THEN USE THIS DATA TO DETERMINE PART NUMBER OF HEATING ELEMENT.



DISCRIPTION	PART NUMBERS					
	120V	208V	240V	277V	347V	600V
LINEAR LIMIT						
28" HEATER	4520-0007-007	4520-0007-007	4520-0007-007	4520-0007-007	4520-0007-007	4520-0007-007
3'	4520-0007-008	4520-0007-008	4520-0007-008	4520-0007-008	4520-0007-008	4520-0007-008
4'	4520-0007-009	4520-0007-009	4520-0007-009	4520-0007-009	4520-0007-009	4520-0007-009
5'	4520-0007-010	4520-0007-010	4520-0007-010	4520-0007-010	4520-0007-010	4520-0007-010
6'	4520-0007-011	4520-0007-011	4520-0007-011	4520-0007-011	4520-0007-011	4520-0007-011
8'	NA	4520-0007-012	4520-0007-012	4520-0007-012	4520-0007-012	4520-0007-012
10'	NA	4520-0007-013	4520-0007-013	4520-0007-013	4520-0007-013	4520-0007-013





DISCONNECT SW.	THERMOSTAT	TRANSFORMER RELAY		24V TRANSFORMER	PNEUMATIC CONTROL
410170001	2-STAGE 5813-0023-000 SINGLE POLE 5813-0024-000	120V 5018-11003-000 208/240V 5018-11003-001	277V 5018-11003-002 347V 5018-11003-003	208/240V PRIMARY 490026001 277V PRIMARY 490026002	ALL MODELS 5216-7027-005

CIRCUIT BREAKER	POWER RELAY	
2-POLE, 30A 1226-7009-013 2-POLE, 60A 1226-7009-010 3-POLE, 30A 1226-7009-005 3-POLE, 60A 1226-7009-002	24V 5018-2017-001 120V 5018-2021-001 208/240V 5018-2021-002	277V 410171003



ASLC SERIES

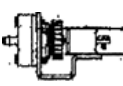

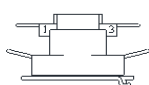
DISCRPTION	PART NUMBERS					
	120V	208V	240V	277V	347V	600V
*ELEMENT (100 WATTS/FT)						
28" HEATER	1802-2001-047	1802-2001-048	1802-2001-049	NA	NA	NA
3'	1802-2001-053	1802-2001-054	1802-2001-055	1802-2001-056	NA	NA
4'	1802-2001-059	1802-2001-060	1802-2001-061	1802-2001-062	1802-2001-232	NA
5'	1802-2001-065	1802-2001-066	1802-2001-067	1802-2001-068	1802-2001-242	NA
6'	1802-2001-071	1802-2001-072	1802-2001-073	1802-2001-074	1802-2001-252	1802-2001-253
8'	NA	1802-2001-077	1802-2001-078	1802-2001-079	1802-2001-262	1802-2001-263
10'	NA	1802-2001-081	1802-2001-082	1802-2001-083	1802-2001-272	1802-2001-273
*ELEMENT (125 WATTS/FT)						
28" HEATER	1802-2001-085	1802-2001-086	1802-2001-048	1802-2001-049	NA	NA
3'	1802-2001-087	1802-2001-088	1802-2001-054	1802-2001-055	1802-2001-220	NA
4'	1802-2001-089	1802-2001-090	1802-2001-060	1802-2001-061	1802-2001-230	NA
5'	1802-2001-091	1802-2001-092	1802-2001-066	1802-2001-067	1802-2001-240	1802-2001-241
6'	1802-2001-093	1802-2001-094	1802-2001-072	1802-2001-073	1802-2001-250	1802-2001-251
8'	NA	1802-2001-095	1802-2001-077	1802-2001-078	1802-2001-260	1802-2001-261
10'	NA	1802-2001-096	1802-2001-081	1802-2001-082	1802-2001-270	1802-2001-271
*ELEMENT (150 WATTS/FT)						
28" HEATER	1802-2001-051	1802-2001-001	1802-2001-000	1802-2001-052	NA	NA
3'	1802-2001-057	1802-2001-007	1802-2001-006	1802-2001-058	1802-2001-218	NA
4'	1802-2001-063	1802-2001-013	1802-2001-012	1802-2001-064	1802-2001-228	NA
5'	1802-2001-069	1802-2001-019	1802-2001-018	1802-2001-070	1802-2001-238	1802-2001-239
6'	1802-2001-075	1802-2001-025	1802-2001-024	1802-2001-076	1802-2001-248	1802-2001-249
8'	NA	1802-2001-031	1802-2001-030	1802-2001-080	1802-2001-258	1802-2001-259
10'	NA	1802-2001-035	1802-2001-034	1802-2001-084	1802-2001-268	1802-2001-269
*ELEMENT (188 WATTS/FT)						
24" HEATER	1802-2001-038	1802-2001-039	1802-2001-040	1802-2001-041	1802-2001-200	NA
28"	1802-2001-005	1802-2001-002	1802-2001-001	1802-2001-000	NA	NA
3'	1802-2001-011	1802-2001-008	1802-2001-007	1802-2001-006	1802-2001-216	NA
4'	1802-2001-017	1802-2001-014	1802-2001-013	1802-2001-012	1802-2001-226	1802-2001-227
5'	1802-2001-023	1802-2001-020	1802-2001-019	1802-2001-018	1802-2001-236	1802-2001-237
6'	1802-2001-029	1802-2001-026	1802-2001-025	1802-2001-024	1802-2001-246	1802-2001-247
8'	NA	1802-2001-032	1802-2001-031	1802-2001-030	1802-2001-256	1802-2001-257
10'	NA	1802-2001-036	1802-2001-035	1802-2001-034	1802-2001-266	1802-2001-267
*ELEMENT (250 WATTS/FT)						
28" HEATER	1802-2001-004	1802-2001-003	1802-2001-002	1802-2001-001	1802-2001-202	NA
3'	1802-2001-010	1802-2001-009	1802-2001-008	1802-2001-007	1802-2001-214	NA
4'	1802-2001-016	1802-2001-015	1802-2001-014	1802-2001-013	1802-2001-224	1802-2001-225
5'	1802-2001-022	1802-2001-021	1802-2001-020	1802-2001-019	1802-2001-234	1802-2001-235
6'	1802-2001-028	1802-2001-027	1802-2001-026	1802-2001-025	1802-2001-244	1802-2001-245
8'	NA	1802-2001-033	1802-2001-032	1802-2001-031	1802-2001-254	1802-2001-255
10'	NA	1802-2001-037	1802-2001-036	1802-2001-035	1802-2001-264	1802-2001-265
						
LINEAR LIMIT	DISCONNECT SW.		THERMOSTAT	P.E. SWITCH		
28" HEATER	4520-0007-007	410170001	2-STAGE	410172001		
3'	4520-0007-008		5813-0023-000			
4'	4520-0007-009		SINGLE POLE			
5'	4520-0007-010		5813-0024-000			
6'	4520-0007-011					
8'	4520-0007-012					
10'	4520-0007-013					
						
TRANSFORMER		POWER RELAY				
120V	277V	24V	208/240V			
5018-11003-000	5018-11003-002	410171001	410171003			
208/240V	347V	120V				
5018-11003-001	5018-11003-003	410171002				



WRL SERIES

ELEMENT

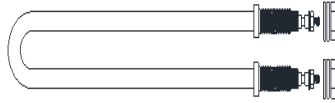
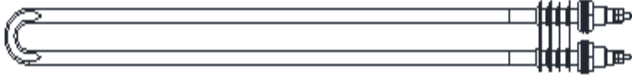

1802-7076-001

L1511B

1802-7076-008

L4521B

HE45240

L4521

1802-7076-003

L2021B

1802-7076-010

L4541B

HE45480

L4541

1802-7076-005

L2041B

1802-7076-011

L4561B

HE20240

L6023

1802-7076-006

L2061B

1802-7076-009

L4571B

HE20480

L6043

1802-7076-004

L2071B

1802-7076-007

L4581B

HE45480

L13543

1802-7076-002

L2081B

RELECTOR

891755004

L1511B

891755002

L4581B

L4541B

L4521B



1.5KW Portable



4.5KW Portable

XRM SERIES

ELEMENT



1802-7076-002 M2081B M6083B	1802-7076-007 M4581B M13583B	1802-2110-007 M6043A	HE45208 M4581 M13583	HE20208 M6083
1802-7076-003 M2021B M6023B	1802-7076-008 M4521B M13523B	1802-2110-009 M4581A M13583A	HE45240 M4521 M13523	HE20240 M6023
1802-7076-004 M6071B	1802-7076-009 M13571B	1802-2110-011 M4521A M13523A	HE45480 M4541 M13543	HE20480 M6043
1802-7076-005 M2041B M6043B	1802-7076-010 M4541B M13543B	1802-2110-015 M4541A M13543A	HE45600 M13563	HE20600 M6063
1802-7076-006 M2061B M6063B	1802-7076-011 M4561B M13563B	1802-2110-016 M13563A		

NOTES

6KW AND 13.5KW UNITS TAKE THREE ELEMENTS



2.0 KW



6.0 KW Fixed



4.5 KW Fixed

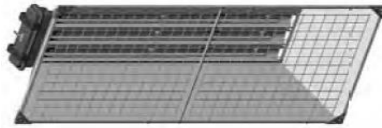

13.5 KW Fixed w/Grille

REFLECTOR

891755004 M6023B M6043B	891755002 M13523B M13543B M4521B M4541B
--------------------------------------	--

YRN SERIES

ELEMENT





1802-2115-001 N1011A	1802-2115-013 N2001A	1802-7077-001 N1011B	1802-7077-009 N2001B
1802-2115-004 N1021A	1802-2115-015 N2021A	1802-7077-003 N1021B	1802-7077-010 N2021B
1802-2115-006 N1031A	1802-2115-017 N2031A	1802-7077-002 N1081B	1802-7077-012 N2031B
1802-2115-005 N1071A	1802-2115-016 N2071A	1802-7077-004 N1511B	1802-7077-011 N2071B
1802-2115-008 N1501A	1802-2115-018 N2501A	1802-7077-006 N1521B	1802-7077-013 N2501B
1802-2115-007 N1511A	1802-2115-020 N2521A	1802-7077-008 N1531B	1802-7077-014 N2521B
1802-2115-010 N1521A	1802-2115-022 N2531A	1802-7077-007 N1571B	1802-7077-016 N2531B
1802-2115-012 N1531A	1802-2115-021 N2571A	1802-7077-005 N1581B	1802-7077-015 N2571B
1802-2115-011 N1571A			





FRR & PMRR SERIES

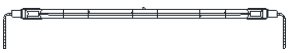

ELEMENT

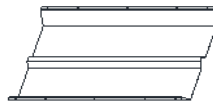
			
1802-0070-509 RR22012A	1802-2113-501 RR41512A	1802-2119-500 RR10512A	1802-2151-001 RR26164
1802-0070-550 RR35724A	1802-2113-516 RR53024A	RR11012A	1802-2151-000 RR26168

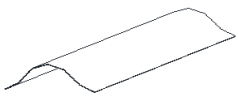
REFLECTOR



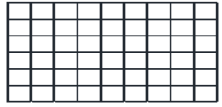
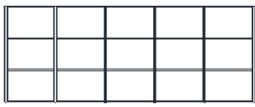

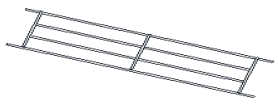
			
5007-2013-000 RR41512A	5007-2020-000 RR22012A	5007-2021-000 RR10512A	5007-2027-000 RR26164
5007-2013-001 RR53024A	5007-2020-001 RR35724A	RR11012A	RR26168

WIRE GUARD

			
2504-2014-000 RR35724A	2504-2015-000 RR22012A	2504-2016-000 RR41512A	2504-2017-000 RR10512A
		2504-2016-001 RR53024A	RR11012A
		2504-2016-002 RR26164	
		RR26168	

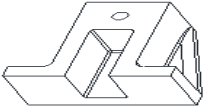
CERAMIC BLOCK

SWITCH





			
1224-0049-000 RR22012A RR26164 RR26168 RR35724A	1224-2006-000 RR10512A RR11012A	410024000 RR11012A	5216-11009-000 RR22012A RR35724A

ELEMENT BUSHING

CORD

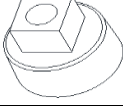



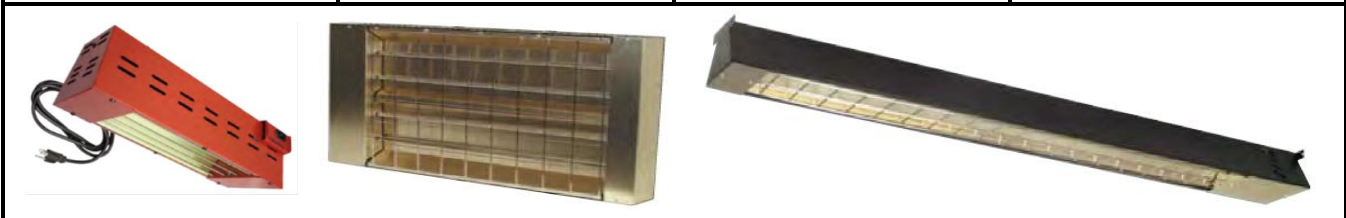

CHAIN 4'



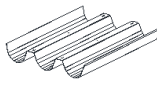

"S" HOOKS

			
1213-0070-000 RR22012A RR26164 RR26168 RR35724A	1420-2016-000 RR10512A RR41512A	1404-2000-001 RR10512A RR11012A	2706-2000-000 RR10512A
	1420-2016-008 RR11012A	RR22012A	RR11012A
	1420-2016-002 RR22012A	RR35724A	RR22012A
	1420-2031-000 RR35724A	RR41512A	RR35724A
	1420-2016-001 RR53024A	RR53024A	RR41512A
			RR53024A

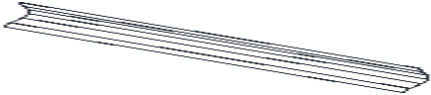

VRP/VRS SERIES RADIANT HEATERS

ELEMENTS					REFLECTOR			
								
PART NUMBER	TYPE	VOLTS	WATTS	USED WITH FIXTURE	5007-2003-000	5007-2003-001	5007-2003-002	
2MS08208 2MS08240 2MS08277 2MS08347 2MS08480 2MS08600	METAL SHEATH	208 240 277 347 480 600	850	RP22 RS2 RP32 RS32	RP223ASA RS223ASA	RP233ASA RS233ASA	RP243ASA RS243ASA	
2QT10208 2QT10240 2QT10277 NA	QUARTS TUBE	208 240 277 NA	1000		5007-2010-000 RP2235A RS2235A	5007-2010-001 RP2335A RS2335A	5007-2010-002 RP2435A RS2435A	
2QL16208 2QL16240 2QL16277 2QL16347 2QL16480 2QL16600	QUARTS LAMP	208 240 277 347 480 600	1600		5007-2011-000 RP226ASA RS226ASA	5007-2011-001 RP236ASA RS236ASA	5007-2011-002 RP246ASA RS246ASA	
3MS15208 3MS15240 3MS15277 3MS15347 3MS15480 3MS15600	METAL SHEATH	208 240 277 347 480 600	1500		RP23 RS23 RP33 RS33	5007-2009-000 RP2265A RP2295A RS2265A RS2295A	5007-2009-001 RP2365A RP2395A RS2365A RS2395A	5007-2009-002 RP2465A RP2495A RS2465A RS2495A
3QT15208 3QT15240 3QT15277 3QT15347 3QT15480 3QT15600	QUARTS TUBE	208 240 277 347 480 600	1500					
3QL25208 3QL25240 3QL25277 3QL25347 3QL25480 3QL25600	QUARTS LAMP	208 240 277 347 480 600	2500			5007-2008-000 RP323ASA RS323ASA	5007-2008-001 RP333ASA RS333ASA	5007-2008-002 RP343ASA RS343ASA
3QT15208 3QT15240 3QT15277 3QT15347 3QT15480 3QT15600	QUARTS TUBE	208 240 277 347 480 600	1500	5007-2017-000 RP3235A RS3235A		5007-2017-001 RP3335A RS3335A	5007-2017-002 RP3435A RS3435A	
3QL25208 3QL25240 3QL25277 3QL25347 3QL25480 3QL25600	QUARTS LAMP	208 240 277 347 480 600	2500	5007-2018-000 RP326ASA RS326ASA		5007-2018-001 RP336ASA RS336ASA	5007-2018-002 RP346ASA RS346ASA	
3QL25208 3QL25240 3QL25277 3QL25347 3QL25480 3QL25600	QUARTS LAMP	208 240 277 347 480 600	2500	5007-2016-000 RP3265A RP3295A RS3265A RS3295A		5007-2016-001 RP3365A RP3395A RS3365A RS3395A	5007-2016-002 RP3465A RP3495A RS3465A RS3495A	
4MS20208 4MS20240 4MS20277 4MS20347 4MS20480 4MS20600	METAL SHEATH	208 240 277 347 480 600	2000	RP24 RS24 RP34 RS34				
4QT20208 4QT20240 4QT20277 4QT20347 4QT20480 4QT20600	QUARTS TUBE	208 240 277 347 480 600	2000		ELEMENT TERM BUSH*		TERMINAL BLOCK*	
4QL36347 4QL36480 4QL36600	QUARTS LAMP	347 480 600	3650		ALL MODELS 1213-0070-000		ALL MODELS 1224-0049-000	
NOTES					* FOUR REQUIRED ON 2 ELEMENT AND SIX FOR 3 ELEMENT FIXTURES			
								

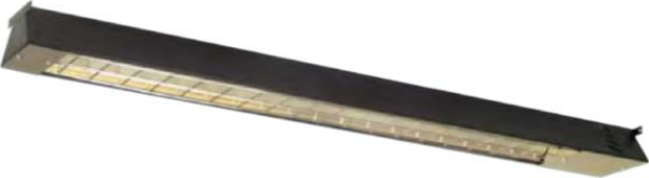

JRK SERIES			
ELEMENT		REFLECTOR	
			
1802-2113-501 RK41512A	1802-2113-515 RK53020A	5007-2013-000 RK41512A RK42020A RK42024A RK42027A RK42034A RK42048A RK42060A	5007-2013-001 RK53020A RK53024A RK53027A RK53034A RK53048A RK53060A
1802-2113-509 RK42020A	1802-2113-516 RK53024A		
1802-2113-510 RK42024A	1802-2113-517 RK53027A		
1802-2113-511 RK42027A	1802-2113-518 RK53034A		
1802-2113-512 RK42034A	1802-2113-519 RK53048A		
1802-2113-513 RK42048A	1802-2113-520 RK53060A		
1802-2113-514 RK42060A			
CHAIN 2 REQ.	"S" HOOK 4 REQ.		
			
1404-2000-001 ALL MODELS	2706-2000-000 ALL MODELS	1402-2275-000 ALL MODELS	1402-2275-001 ALL MODELS
			

BHRA & BVRC SERIES		
ELEMENT	BHRA66	BHRA11
PICTURE NOT AVAILABLE		
IFCQL115A HRA11115W HRARC11115W	IFCQL420A HRA66420BA VRC4420SG VRC4440DWG VRC4440DTG	
2 ELEMENTS REQ ON 4000 WATT MODELS		
BVRC4440DWG	BVRC4440DTG	BVRC4420SG
		

RCC COVE HEATERS (C & D SERIES)

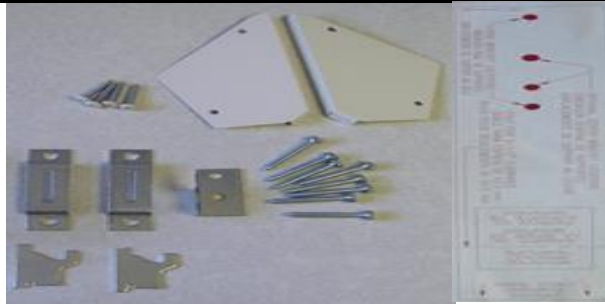
PARTS KIT*

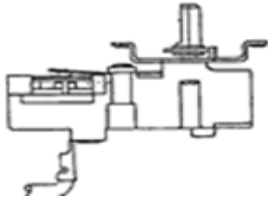

WHITE 3303-2032-000	DOVE GRAY 3303-2032-001	DESERT TAN 3303-2032-002
CENTER SUP BRACKET**	THERMOSTAT	THERMOSTAT KNOB
		
ALL MODELS 1215-2309-000	ALL MODELS 410129001	ALL MODELS 3301-2020-006













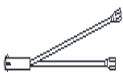

NOTES

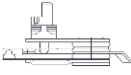

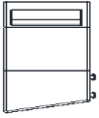

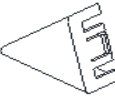





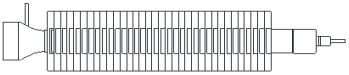
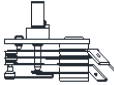

REPLACE HEATER IF FRONT COVER OR ELEMENT IS NEEDED

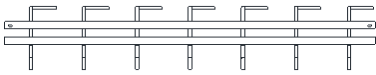
*** PARTS KIT INCLUDES MOUNTING BRACKETS, MOUNTING TEMPLATE, AND END CAPS**



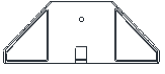

**** 1500 & 1800 WATT MODELS TAKE TWO CENTER SUPPORT BRACKETS**





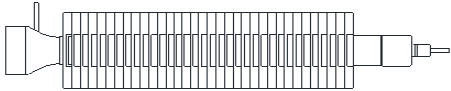
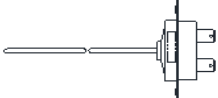
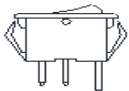
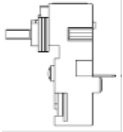
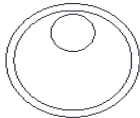

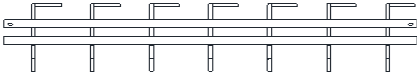



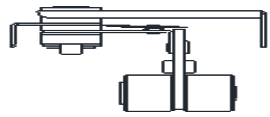

FBE SERIES					
ELEMENT		SWITCH			LIGHT
					
1802-2087-000 FBE15002C FBE15002CA		5216-2007-000 FBE1000A FBE1200 FBE1250A	5216-2010-000 FBE15002 FBE15002A	5216-2027-000 FBE15002B FBE15002C FBE15002CA	3510-2008-001 FBE1504C
LIMIT	THERMOSTAT	KNOB		FACE PLATE	
					
4520-2011-004 FBE1500C FBE15002A FBE15002B FBE15002C FBE15002CA	5813-2058-001 FBE1200 FBE1200C FBE1500C FBE15002B FBE15002C FBE15002CA FBE1504C	3301-2017-000 FBE1000A FBE1250A FBE15002 FBE15002A	3301-2011-003 FBE1200 FBE1200C FBE1500C FBE15002B FBE15002C FBE15002CA FBE1504C	1402-2122-139 FBE1000A	1402-2122-136 FBE15002
				1402-2122-141 FBE1200	1402-2122-138 FBE15002A
				1402-2122-125 FBE1200C	1402-2122-142 FBE15002B
				1402-2122-140 FBE1250A	1402-2122-626 FBE15002CA
END CAP RIGHT	END CAP LEFT	LEG RIGHT	LEG LEFT	CORD	CONTROL COVER
					
1800-2047-001 FBE1200C FBE1500C FBE15002C FBE15002CA FBE1504C	1800-2048-001 FBE1200C FBE1500C FBE15002C FBE15002CA FBE1504C	3507-2004-001 FBE1200C FBE1500C FBE15002C FBE15002CA FBE1504C	3507-2005-001 FBE1200C FBE1500C FBE15002C FBE15002CA FBE1504C	1420-2027-001 FBE15002C 1420-11013-000 FBE15002CA	1402-2243-001 FBE15002B FBE15002C FBE15002CA
					

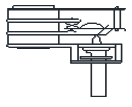
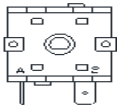
LFP SERIES					
ELEMENT		THERMOSTAT		LIMIT	
					
1802-2067-023 LFP6152D LFP6152E LFP6152EA	1802-2067-001 LFP675D	5813-2019-000 LFP6152 LFP6152D LFP6152E LFP6152EA	5813-2001-000 LFP675 LFP675D	410163004 LFP6152 LFP6152D LFP6152E LFP6152EA	4520-2010-001 LFP675 LFP675D
GRILLE	LIGHT	DIODE BRIDGE	FRONT COVER	CORD	
					
2501-2012-015 LFP6152 LFP6152D LFP6152E LFP6152EA	2501-2012-013 LFP675 LFP675D	3510-2006-000 LFP6152 LFP6152D LFP6152E LFP6152EA	DBKIT LFP6152 LFP6152D LFP6152E LFP6152EA	1402-2066-609 LFP6152EA	1420-11013-000 LFP6152D LFP6152E LFP6152EA
KNOB	LEG	SWITCH	END CAP		
					
3301-2011-001 LFP6152 LFP6152D LFP6152E LFP6152EA LFP675 LFP675D	3507-2003-000 LFP6152 LFP6152D LFP6152E LFP6152EA LFP675 LFP675D	5216-2007-000 LFP6152 LFP6152D LFP6152E LFP6152EA LFP675 LFP675D	1800-2027-000 LFP6152 LFP6152D LFP6152E LFP6152EA LFP675 LFP675D		

FHP SERIES

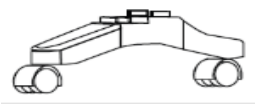

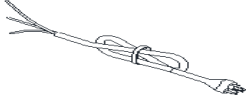
ELEMENT		LIMIT		SWITCH
				
1802-2067-001 FHP0750KCT FHP0750KCTA FHP0750T FHP0750TA	1802-2067-023 FHP1500KCT FHP1500KCTA FHP1500T FHP1500TA	4520-0011-000 FHP0750KCT FHP0750KCTA FHP0750T FHP0750TA	410163004 FHP1500KCT FHP1500KCTA FHP1500T FHP1500TA	5216-2007-000 FHP0750KCT FHP0750KCTA FHP0750T FHP0750TA FHP1500KCT FHP1500KCTA FHP1500T FHP1500TA
THERMOSTAT	KNOB	FRONT COVER		END CAP
				
5813-11012-000 FHP0750KCT FHP0750KCTA FHP0750T FHP0750TA FHP1500KCT FHP1500KCTA FHP1500T FHP1500TA	3301-2011-005 FHP0750KCT FHP0750KCTA FHP0750T FHP0750TA FHP1500KCT FHP1500KCTA FHP1500T FHP1500TA	1402-2066-607 FHP0750KCT FHP0750KCTA FHP0750T FHP0750TA	1402-2066-609 FHP1500KCT FHP1500KCTA FHP1500T FHP1500TA	1800-2027-000 FHP0750KCT FHP0750KCTA FHP0750T FHP0750TA FHP1500KCT FHP1500KCTA FHP1500T FHP1500TA
GRILLE		LEGS (2 REQ)	CORD	
				
2501-2012-013 FHP0750KCT FHP0750KCTA FHP0750T FHP0750TA	2501-2012-015 FHP1500KCT FHP1500KCTA FHP1500T FHP1500TA	3507-2003-000 FHP0750KCT FHP0750KCTA FHP0750T FHP0750TA FHP1500KCT FHP1500KCTA FHP1500T FHP1500TA	1420-11013-000 FHP0750KCT FHP0750KCTA FHP0750T FHP0750TA FHP1500KCT FHP1500KCTA FHP1500T FHP1500TA	

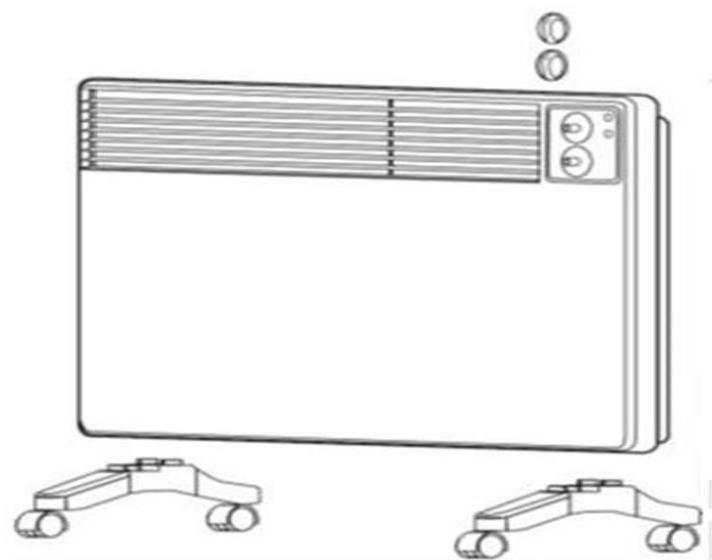

WPC SERIES			
ELEMENT	TIP OVER SW.	LIMIT	THERMOSTAT
			
1802-10822-000 WPC1500A 1802-11017-000 (500W) 1802-11017-001 (1000W) WPC1500B WPC1500C	5216-11004-000 WPC1500A	410122002 WPC1500A 4520-11004-003 WPC1500B WPC1500C	5813-2092-001 WPC1500A WPC1500B WPC1500C
4 POSITION SW.	PORT SWITCH	LIGHT RED	PILOT LIGHT AMBER
			
5216-2071-000 WPC1500A WPC1500B WPC1500C	5216-2073-000 WPC1500A WPC1500B WPC1500C	3510-2021-002 WPC1500A 3510-2021-004 WPC1500B WPC1500C	3510-11518-000 WPC1500A WPC1500B WPC1500C
WHEEL KIT (2 REQ)	HOLE PLUG (2 REQ)	CORD	KNOB (2 REQ)
			
1205-10305-000 WPC1500A WPC1500B WPC1500C	4506-2022-000 WPC1500A WPC1500B WPC1500C	1420-2029-009 WPC1500A WPC1500B WPC1500C	3301-2058-000 WPC1500A WPC1500B WPC1500C



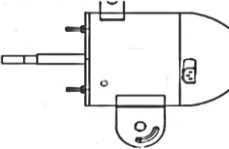
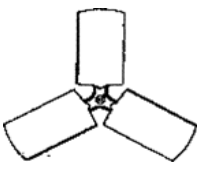
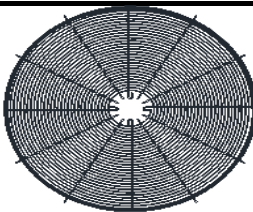

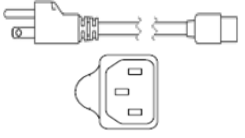



SAFETY YELLOW HIGH PERFORMANCE AIR CIRCULATOR AF30H

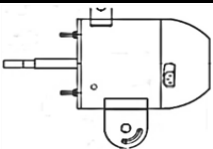
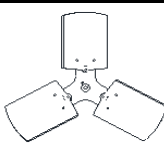
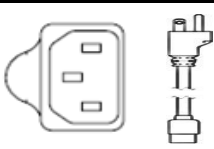
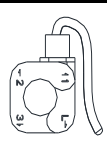

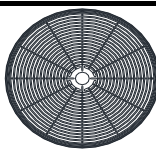
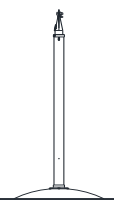

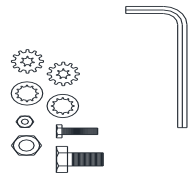
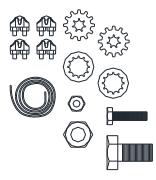

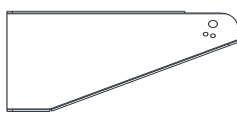
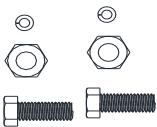
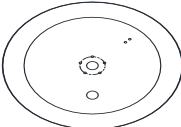
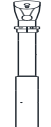

MOTOR	BLADE	GUARD (2 REQ)
		
<p align="center">3900-11014-000 AF30HA</p>	<p align="center">1210-2026-000 AF30H AF30HA</p>	<p align="center">372-079-Y AF30H AF30HA</p>
SWITCH		CORD
		
<p align="center">5216-2051-001 AF30H</p>	<p align="center">1016-11054-001 AF30HA</p>	<p align="center">1420-11004-000 AF30HA</p>
<p>PLUG CONFIGURATION ABOVE IS ONLY TYPE AVAILABLE, IF MOTORS USE DIFFERENT CONFIGURATION THE MOTOR MUST BE REPLACED AS WELL.</p>		

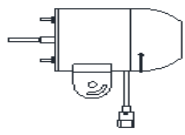
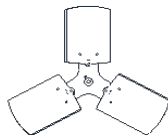
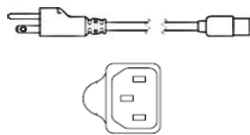
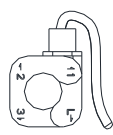

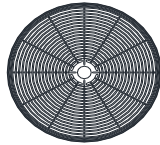

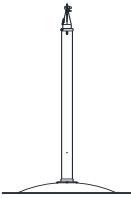
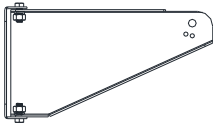
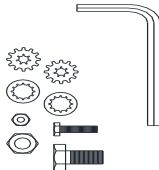
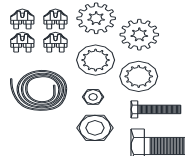
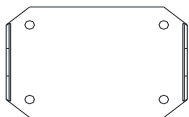

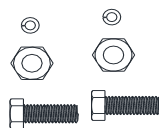
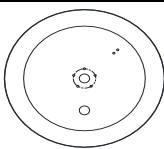





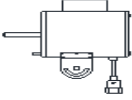
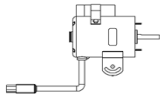
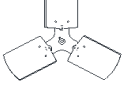

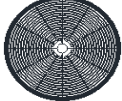

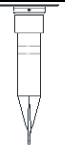
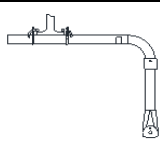

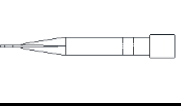

HIGH PERFORMANCE AIR CIRCULATOR MACH 24 & 30

MOTOR	BLADE		CORD	SWITCH
				
3900-11011-000 MACH24A MACH24P MACH24W MACH30A MACH30P MACH30W	1210-2014-000 MACH24A MACH24P MACH24W	1210-2026-000 MACH30A MACH30P MACH30W	1420-11004-000 MACH24A MACH24P MACH24W MACH30A MACH30P MACH30W	5216-2059-000 MACH24A MACH24P MACH24W MACH30A MACH30P MACH30W
GUARD REAR		GUARD FRONT		
				
2504-2039-004 MACH24A MACH24P MACH24W	2504-2037-004 MACH30A MACH30P MACH30W	2504-2040-004 MACH24A MACH24P MACH24W	2504-2038-004 MACH30A MACH30P MACH30W	
MOUNTING KIT* (COMPLETE ASY)		ACCESSORY KIT		
				
2430PBA MACH24P MACH30P	2430WGA MACH24W MACH30W	002-057 MACH24P MACH30P	3277 MACH24W MACH30W	
WALL MT BASE	WALL MT ARM	WALL MT KIT	PEDESTAL BASE	COLUMN
				
045-131-B MACH24W MACH30W	1215-2233-000 MACH24W MACH30W	991-473 MACH24W MACH30W	1208-2013-001 MACH24P MACH30P	1446-0003-002 MACH24P MACH30P
PLUG CONFIGURATION ABOVE IS ONLY TYPE AVAILABLE, IF MOTORS USE DIFFERENT CONFIGURATION THE MOTOR MUST BE REPLACED AS WELL.				

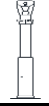







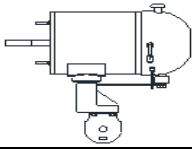
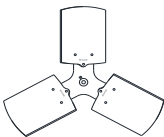
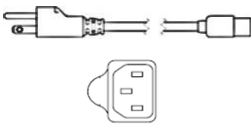
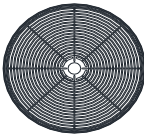
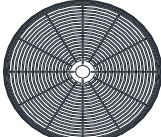
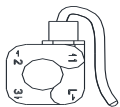
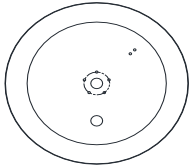

INDUSTRIAL AIR CIRCULATOR 24ACH & 30ACH				
MOTOR	BLADE		CORD	SWITCH
				
3900-11009-000 24ACHA 24ACHP 24ACHW 30ACHA 30ACHP 30ACHW	1210-2014-000 24ACHA 24ACHP 24ACHW	1210-2026-000 30ACHA 30ACHP 30ACHW	1420-11004-000 24ACHA 24ACHP 24ACHW 30ACHA 30ACHP 30ACHW	5216-2059-000 24ACHA 24ACHP 24ACHW 30ACHA 30ACHP 30ACHW
GUARD REAR		GUARD FRONT		
				
2504-2039-004 24ACHA 24ACHP 24ACHW	2504-2037-004 30ACHA 30ACHP 30ACHW	2504-2040-004 24ACHA 24ACHP 24ACHW	2504-2038-004 30ACHA 30ACHP 30ACHW	
MOUNTING KIT* (COMPLETE ASY)		ACCESSORY KIT		
				
2430PBA 24ACHP 30ACHP	2430WGA 24ACHW 30ACHW	002-057 24ACHP 30ACHP	3277 24ACHW 30ACHW	
WALL MT BASE	WALL MT ARM	WALL MT KIT	PEDESTAL BASE	COLUMN
				
045-131-B 24ACHW 30ACHW	1215-2233-000 24ACHW 30ACHW	991-473 24ACHW 30ACHW	1208-2013-001 24ACHP 30ACHP	1446-0003-002 24ACHP 30ACHP
PLUG CONFIGURATION ABOVE IS ONLY TYPE AVAILABLE, IF MOTORS USE DIFFERENT CONFIGURATION THE MOTOR MUST BE REPLACED AS WELL.				

EXTRA HEAVY DUTY AIR CIRCULATOR 24HDH 30HDH & 36HDH SERIES

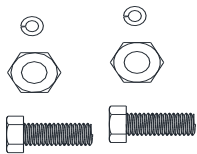
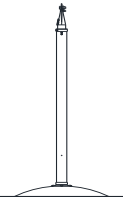
MOTOR		BLADE			
					
3900-11013-000 24HDHA 24HDHC 24HDHI 24HDHP 24HDHW 30HDHA 30HDHC 30HDHI 30HDHP 30HDHW	3900-11030-000 30HDHB 30HDHCB 30HDHIB 30HDHPB 30HDHWPB 36HDHA 36HDHB	1210-2035-000 24HDHA 24HDHC 24HDHI 24HDHP 24HDHW 1210-2026-001 30HDHA 30HDHC 30HDHI 30HDHP 30HDHW	1210-2037-000 36HDHA 36HDHB LCCLIN3016BL 30HDHB 30HDHCB 30HDHIB 30HDHPB 30HDHWPB		
GUARD REAR		GUARD FRONT			
					
2504-2039-004 24HDHA 24HDHC 24HDHI 24HDHP 24HDHW	2504-2037-004 30HDHA 30HDHB 30HDHC 30HDHCB 30HDHI	2504-2040-004 24HDHA 24HDHC 24HDHI 24HDHP 24HDHW	2504-2038-004 30HDHA 30HDHB 30HDHC 30HDHCB 30HDHI	PULL CHAIN SWITCH	
2504-2048-004 36HDHA 36HDHB	30HDHIB 30HDHP 30HDHPB 30HDHW 30HDHWPB	2504-2049-004 36HDHA 36HDHB	30HDHIB 30HDHP 30HDHPB 30HDHW 30HDHWPB		
MOUNTING KIT* (COMPLETE ASY)				CORD	PARTS KIT
					
2430C 24HDHC 30HDHC 30HDHCB	2430I 24HDHI 30HDHI 30HDHIB	2430PBA 24HDHP 30HDHP 30HDHPB	2430WGA 24HDHW 30HDHW 30HDHWPB	1420-11004-000 WITH 3900-11030-000 MOTORS ONLY	1016-0068-000 ALL MODELS
I-BEAM CLAMPS	I-BEAM BENT	I-BEAM 13"	CEILING MOUNT	PEDESTAL BASE	COLUMN
					
LPIBC 24HDHI 30HDHI 30HDHIB	LIB002 24HDHI 30HDHI 30HDHIB	LIB003 24HDHC 24HDHI 30HDHC 30HDHCB 30HDHI 30HDHIB	L2430CM 24HDHC 30HDHC 30HDHCB	1208-2013-001 24HDHP 30HDHP 30HDHPB	1446-0003-002 24HDHP 30HDHP 30HDHPB
WALL MT BASE	WALL MT ARM	WALL MT KIT	PULLCHAIN STRING	ACCESSORY KIT	
					
045-131-B 24HDHW 30HDHW 30HDHWPB	1215-2233-000 24HDHW 30HDHW 30HDHWPB	991-473 24HDHW 30HDHW 30HDHWPB	3378 24HDHC 24HDHI 24HDHW 30HDHC 30HDHCB 30HDHI 30HDHIB 30HDHW 30HDHWPB	3277 24HDHC 24HDHI 24HDHW 30HDHC 30HDHCB 30HDHI 30HDHIB 30HDHW 30HDHWPB	002-057 24HDHP 30HDHP 30HDHPB
<p>PLUG CONFIGURATION ABOVE IS ONLY TYPE AVAILABLE, IF MOTORS USE DIFFERENT CONFIGURATION THE MOTOR MUST BE REPLACED AS WELL.</p>					

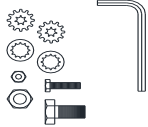
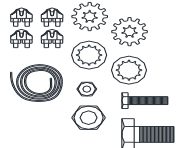
INDUSTRIAL OSCILLATING AIR CIRCULATOR 24ACHO & 30ACHO



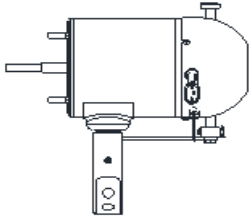
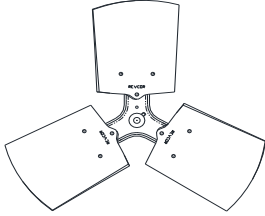
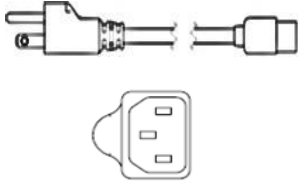
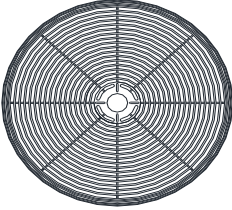
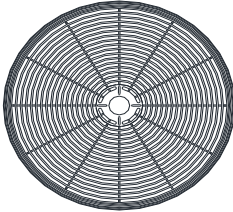
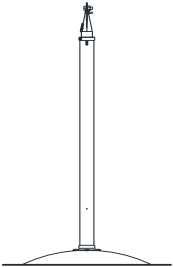
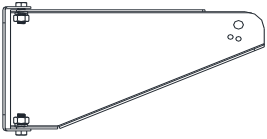

MOTOR	BLADE		CORD	HARDWARE KIT
				PICTURE NOT AVAILABLE
3900-11010-000 24ACHOA 24ACPOUA 24ACWOUA 30ACHOA 30ACPOUA 30ACWOUA	1210-2014-000 24ACHOA 24ACPOUA 24ACWOUA	1210-2026-000 30ACHOA 30ACPOUA 30ACWOUA	1420-11004-000 24ACHOA 24ACPOUA 24ACWOUA 30ACHOA 30ACPOUA 30ACWOUA	4092 24ACPOUA 24ACWOUA 30ACPOUA 30ACWOUA
GUARD REAR		GUARD FRONT		SWITCH
				
2504-2039-004 24ACHOA 24ACPOUA 24ACWOUA	2504-2037-004 30ACHOA 30ACPOUA 30ACWOUA	2504-2040-004 24ACHOA 24ACPOUA 24ACWOUA	2504-2038-004 30ACHOA 30ACPOUA 30ACWOUA	5216-2059-000 24ACHOA 24ACPOUA 24ACWOUA 30ACHOA 30ACPOUA 30ACWOUA
PEDESTAL BASE	COLUMN	WALL MT BASE	WALL MT ARM	WALL MT KIT
				
1208-2013-001 24ACPOUA 30ACPOUA	1446-0003-002 24ACPOUA 30ACPOUA	045-131-B 24ACWOUA 30ACWOUA	1215-2233-000 24ACWOUA 30ACWOUA	991-473 24ACWOUA 30ACWOUA
MOUNTING BKT (COMPLETE)		ACCESSORY KIT		
				
2430PBA 24ACPOUA 30ACPOUA	2430WGA 24ACWOUA 30ACWOUA	002-057 24ACPOUA 30ACPOUA	3277 24ACWOUA 30ACWOUA	
PLUG CONFIGURATION ABOVE IS ONLY TYPE AVAILABLE, IF MOTORS USE DIFFERENT CONFIGURATION THE MOTOR MUST BE REPLACED AS WELL.				

LCHHD HEAVY DUTY OSSILLATING AIR CIRCULATOR

MOTOR	BLADE		CORD
			
3900-11012-000 LCHHD240 LCHHD300	1210-2014-000 LCHHD240	1210-2026-000 LCHHD300	1420-11004-000 LCHHD240 LCHHD300
GUARD REAR		GUARD FRONT	
			
2504-2039-004 LCHHD240	2504-2037-004 LCHHD300	2504-2040-004 LCHHD240	2504-2038-004 LCHHD300
MOUNTING KIT (COMPLETE)		PARTS KIT	
		PICTURE NOT AVAILABLE	
2430PBA LCHHD247 LCHHD307	2430WGA LCHHD247 LCHHD307	3303-2015-000 LCHHD240 LCHHD300	
PLUG CONFIGURATION ABOVE IS ONLY TYPE AVAILABLE, IF MOTORS USE DIFFERENT CONFIGURATION THE MOTOR MUST BE REPLACED AS WELL.			

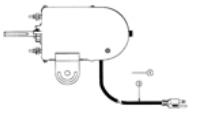
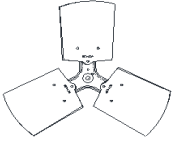
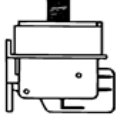

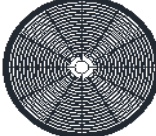

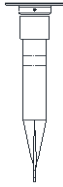
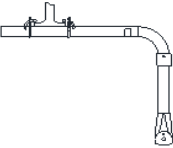
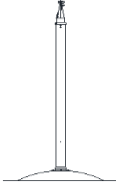

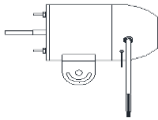
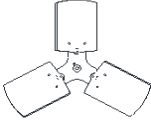

LCHWD SPECIALTY WASH DOWN CIRCULATOR

MOTOR	BLADE		SWITCH	SWITCH BULB
				
3900-2063-000 LCHWD24 LCHWD24WB LCHWD30 LCHWD30WB LCHWD30CM LCHWD30LIB LCHWD30P	LCCLIN2419BL LCHWD24 LCHWD24WB	LCCLIN30BL LCHWD30 LCHWD30WB LCHWD30CM LCHWD30LIB LCHWD30P	LP054 LCHWD24 LCHWD24WB LCHWD30 LCHWD30WB LCHWD30CM LCHWD30LIB LCHWD30P	LP055 LCHWD24 LCHWD24WB LCHWD30 LCHWD30WB LCHWD30CM LCHWD30LIB LCHWD30P
GUARD REAR		GUARD FRONT		
				
2504-2039-003 LCHWD24 LCHWD24WB	2504-2037-003 LCHWD30 LCHWD30WB LCHWD30CM LCHWD30LIB LCHWD30P	2504-2040-003 LCHWD24 LCHWD24WB	2504-2038-003 LCHWD30 LCHWD30WB LCHWD30CM LCHWD30LIB LCHWD30P	
MOUNTING KIT (COMPLETE)				
				
LWBWD LCHWD24WB LCHWD30WB	LCMWD LCHWD30CM	LIBWD LCHWD30LIB	LFPCBWD LCHWD30P	

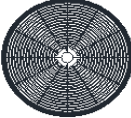
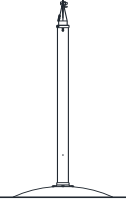

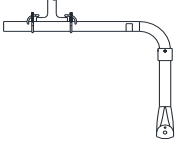



LCHHD SPECIALTY 277V AIR CIRCULATOR



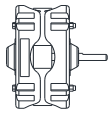
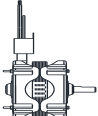
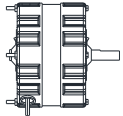
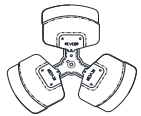
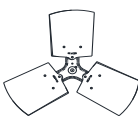
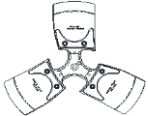
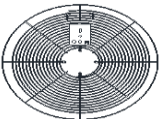

MOTOR		BLADE		CORD
				
3900-2078-000 LCHHD247 LCHHD307		1210-2014-000 LCHHD247		1210-2026-000 LCHHD307
1420-2013-500 LCHHD247 LCHHD307				
GUARD REAR		GUARD FRONT		
				
2504-2039-004 LCHHD247		2504-2037-004 LCHHD307		2504-2040-004 LCHHD247
2504-2038-004 LCHHD307				
MOUNTING KIT (COMPLETE)				
				
				
2430PBA LCHHD247 LCHHD307		2430C LCHHD247 LCHHD307		2430I LCHHD247 LCHHD307
2430WGA LCHHD247 LCHHD307				

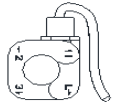

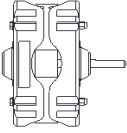
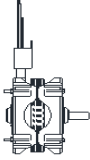
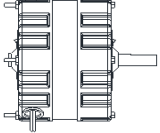
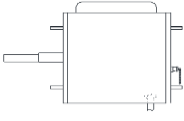
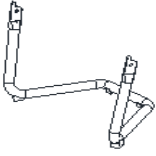
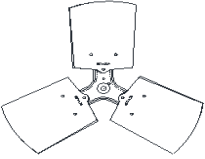
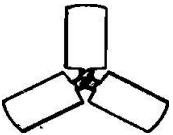

B-SERIES UTILITY CIRCULATORS

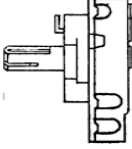
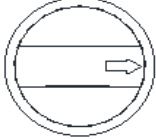
MOTOR			BLADE		
					
517-116-BL B12P B12PA 517-117-BL B14 B14A	517-084-BL B18 B18A B20P B20PA	517-103 B18TE B18TEA	1210-2027-000 B12PA	1210-2023-000 B14 B14A 1210-2013-000 B18 B18A B18TE B18TEA	1210-2036-000 B20PA
GUARD REAR			GUARD FRONT		
					
372-050-AG B12P B12PA 372-074-AG B14A	372-054-AG B18 B18A B18TE B18TEA	372-056-AG B20P B20PA	372-065-AG B12P B12PA 372-066-AG B14 B14A	372-067-AG B18 B18A B18TE B18TEA 372-078-AG B20P B20PA	
YOKE			CORD	SWITCH	
					
3338 B12P B12PA 3339 B14 B14A	1363 B18 B18A B18TE B18TEA	4174 B20P B20PA	118 ALL MODELS	5216-2059-000 ALL MODELS	

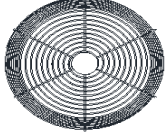



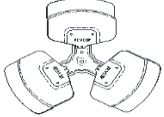
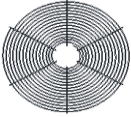
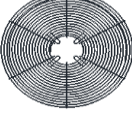

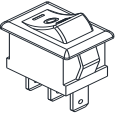
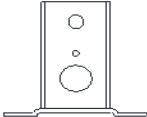



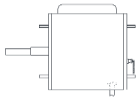
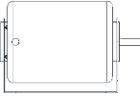
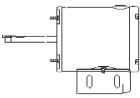
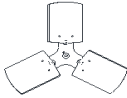
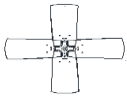



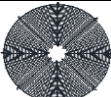

I-SERIES INDUSTRIAL FLOOR CIRCULATOR

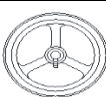
I-SERIES INDUSTRIAL FLOOR CIRCULATOR					
MOTOR				STAND	
			PICTURE NOT AVAILABLE		
517-116-BL I12	517-084-BL I18 I20 I20CA	517-103 I18TE	517-089 I24	1010MB I30	991-629-C I18 I18TE
BLADE			CORD	SWITCH	KNOB
	PICTURE NOT AVAILABLE				
1210-2013-000 I18 I18TE	991-284 I20 I20CA	1210-2026-000 I30	118 I12 I18 I18TE I20 I20CA	16000 I12 I18 I18TE I20 I20CA	441-229-B I12 I18 I18TE I20 I20CA I24
GUARD REAR		GUARD FRONT			
					
372-054-AG I18 I18TE	372-065-AG I12	372-067-AG I18 I18TE	372-078-AG I20 I20CA		

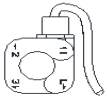
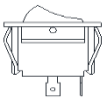

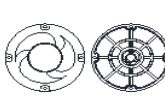



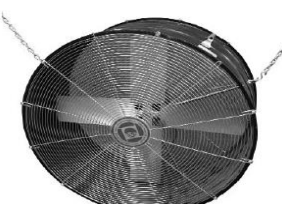



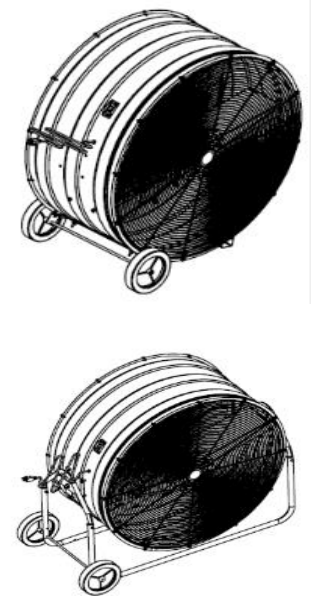

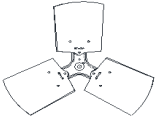
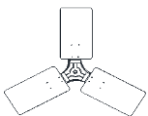
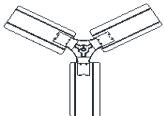
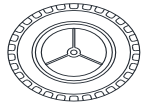
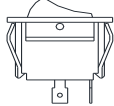
NAVY FAN N12

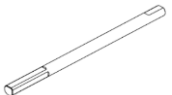
MOTOR	BLADE	GUARD FRT	GUARD BCK
			
3900-11027-000 N12A	1210-2027-001 N12 N12A	372-045-OP N12 N12A	372-046-OP N12 N12A
SWITCH	BASE ASY		
			
4425 N12 N12A	991-124-OP N12 N12A		

MVB SERIES DRUM BLOWER

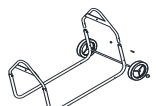

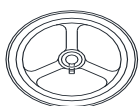
MVB SERIES DRUM BLOWER						
MOTOR			BLADE		CART ASY	SAFETY CABLE
						
1010MB MVB30DA MVB30DB MVB30DS 517-133 MVB30DC MVB36DA MVB36DB MVB36DC MVB36DS	3900-2068-000 MVB36B MVB42B	3900-11001-000 MVB42DB MVB42DS MVB48DB	1210-2026-000 MVB30DA MVB30DB MVB30DC MVB30DS 1210-10558-000 MVB42DB MVB42DS 1210-10560-000 MVB48DB	1210-2012-000 MVB36DA MVB36DB MVB36DC MVB36DS	1016-10724-000 MVB30DC 1016-10724-001 MVB36DC	9G053947 MVB30DS MVB36DS MVB42DS
WHEEL AXLE	WHEEL (2REQ)	HANDLE	GUARD (2REQ)		PULLEY FAN	
						
1017-0003-000 MVB30DA MVB30DB MVB36B MVB36DA MVB36DB MVB42B MVB42DB MVB48DB 1017-0003-002 MVB30DC MVB36DC	869-007 MVB30DA MVB30DB MVB30DC MVB36B MVB36DA MVB36DB MVB36DC MVB42B MVB42DB MVB48DB	3232 MVB30DA MVB30DB MVB36B MVB36DA MVB36DB MVB42B MVB42DB MVB48DB	3466-AG MVB30DA MVB30DB MVB30DC MVB30DS 3293-AG MVB42B MVB42DB MVB42DS 3294-AG MVB48DB	2794-AG MVB36B MVB36DA MVB36DB MVB36DC MVB36DS	1064 MVB36B PULLEY MOTOR  2594 MVB36B	612-015 MVB42B  4507-2009-000 MVB42B
PULL CHAIN SW.	PUSH SWITCH	ROTARY SWITCH	ROCKER SW.	BELT	SHAFT	BEARINGS (2REQ)
	PICTURE NOT AVAILABLE	PICTURE NOT AVAILABLE				
5216-2059-000 MVB24D MVB30DA MVB30DB MVB30DC MVB30DS MVB36DA MVB36DB MVB36DC MVB36DS	5216-2057-000 MVB24D	5216-2058-000 MVB24D	5216-2052-000 MVB36B MVB42B MVB42DB MVB42DS MVB48DB	2341 MVB36B 4160 MVB42B	682-269 MVB36B MVB42B	3764 MVB36B MVB42B
CORD	   					
1420-2023-000 MVB42DB MVB42DS MVB48DB						

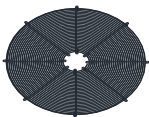
IDF SERIES DRUM BLOWER

IDF SERIES DRUM BLOWER				
MOTOR	BLADE			
				
3900-11023-000 ALL MODELS	1210-2020-001 IDF36B IDF36BC	1210-2025-001 IDF42B IDF42BC	1016-0044-001 IDF48B IDF48BC	
WHEEL (2REQ)	ROCKER SW.	BELT	PULLY MOTOR	
				
869-007 ALL MODELS	5216-2052-000 ALL MODELS	9707-8055 ALL MODELS	2594 ALL MODELS	
SHAFT	CORD	AXLE PILLOW BLK (2REQ)	CAPACITOR	
				
8856-8014 ALL MODELS	1420-2023-000 ALL MODELS	1209-11001-000 ALL MODELS	6100-8026 ALL MODELS	
CART ASY	WHEEL AXLE	PULLEY FAN	HANDLE	
				
1016-10724-001 IDF36BC	1017-0003-000 IDF36B	612-015 ALL MODELS	3232 IDF36B	2794-AG IDF36B
1016-10724-002 IDF42BC	IDF42B IDF48B		IDF42B IDF48B	3293-AG IDF42B
1016-10724-003 IDF48BC	1017-0003-002 IDF36BC IDF42BC IDF48BC			3294-AG IDF48B IDF48BC

INDUSTRIAL CEILING FANS

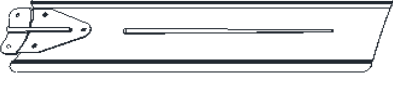

BLADE (SET)

						
9B3620-1 36201	9B4820-3 48203	9B5600-1 56001	9B6000-1 60001	9B5630-1R 56301RDP		
9B4820-1 48201 48207	9B5600-1LC 56001LC 56101	56002 56003 56007	9B6001-1 60011			
9B4820-1B 48201B	56111	9B5601-1 56011	9B6011-1 60101 60111			
		9B5600-1B 56001B	9B5620-1 56201			

DOWNROD 24"

DOWNROD 8"

MOTOR

		
---	---	---

9D24BW 36201 48201 56001LC 56001 56002 56003 56007 56301RDP 48203 48207 60001 56201	9D24BBLK 48201B 56001B 9D24BB 56011 60011 9D12TW 56101 56111 60101 60111	9D08 36201 48201 56001LC 56003 48203 9D08BBLK 48201B	9M3620-1-A 36201 9M4820-1-A 48201 9M4820-1B-A 48201B 9M4820-3-A 48203 9M5600-7-A 48207 6011-1U 60101 60111	9M5600-1LC-A 56001LC 9M5600-1-A 56001 9M5600-1B-A 56001B 9M5600-4-A 56002 9M5600-3-A 56003 9M5600-7-A 56007	9M5601-1-A 56011 5611-1U 56101 56111 9M5630-1R-A 56301RDP 9M6000-1-A 60001 9M6001-1-A 60011 9M5620-1-A 56201
--	---	---	--	--	--

RUBBER ROLLER

J HOOK KIT

BLADE SCREWS (6 REQ)

BLADE PADS (3 REQ)

REVERSIBLE TOGGLE

REVERSING SW. PLATE



					
9F2900-04A ALL MODELS	9F2900-01 ALL MODELS	9F2900-20A ALL MODELS	9F2900-19A ALL MODELS	9F2GX54-73 56301RDP	9FP005 56301RDP

CANOPY UPPER

CANOPY LOWER



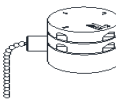



	
---	---

9F2900-07A 36201 48201 56001LC 56001 56002 56003 56007 56301RDP 48203 48207 60001 56201	9F2900-07AB 48201B 56001B 9FP029 56011 60011 3100039A 56101 56111 60101 60111	9F2900-08A 36201 48201 56001LC 56001 56002 56003 56007	9F2900-08B 60001 60101 60111 56301RDP 48203 48207 56101 56111	9F2900-08AB 48201B 56001B 9FP030 56011 60011
--	--	--	--	---

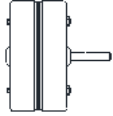
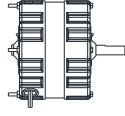
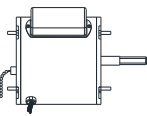
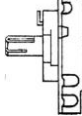
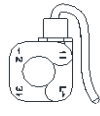
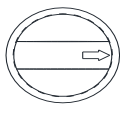

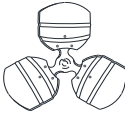
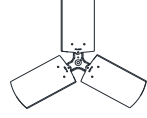
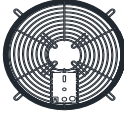
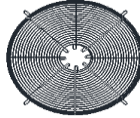
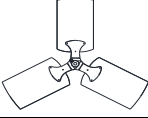

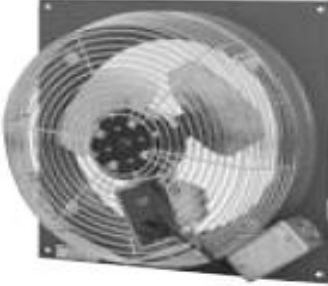

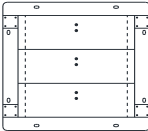
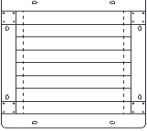
3-SPEED PULL CHAIN SW.	PULL CHAIN STRING	OUTDOOR KIT
		PICTURE NOT AVAILABLE
9F2900-26 48203 56003	3378 48203 56003	99992 56101 60101



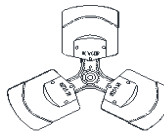
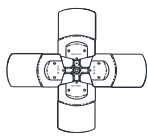
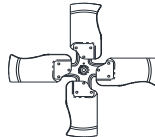
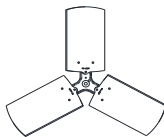
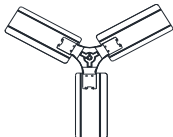
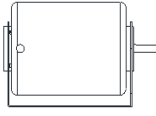
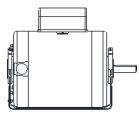

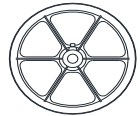

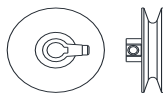

LPE SERIES

MOTOR			SWITCH		KNOB
					
3808 LPE12 LPE12A LPE12S LPE12SA LPE12V LPE12VA	517-103 LPE16 LPE16A LPE16S LPE16SA LPE16V LPE16VA	3900-2040-000 LPE22V LPE22VA LPE24 LPE24A LPE24S LPE24SA LPE30 LPE30A LPE30S LPE30SA	16000 LPE12 LPE12A LPE12S LPE12SA LPE12V LPE12VA LPE16 LPE16A LPE16S LPE16SA LPE16V LPE16VA	5216-2059-000 LPE22V LPE22VA LPE24 LPE24A LPE24S LPE24SA LPE30 LPE30A LPE30S LPE30SA	441-229-B LPE12 LPE12A LPE12S LPE12SA LPE12V LPE12VA LPE16 LPE16A LPE16S LPE16SA LPE16V LPE16VA
BLADE ASY			GUARD		
					
1210-2027-000 LPE12A LPE12SA LPE12VA	490013001 LPE16A	1210-2014-000 LPE24 LPE24A LPE24S LPE24SA	372-082-AG LPE12 LPE12A LPE12S LPE12SA	372-086-AG LPE16 LPE16A LPE16S LPE16SA	372-087-AG LPE24 LPE24A LPE24S LPE24SA
		1210-2026-000 LPE30 LPE30A LPE30S LPE30SA	372-085-AG LPE12V LPE12VA	372-084-AG LPE16V LPE16VA	372-088-AG LPE30 LPE30A LPE30S LPE30SA
1210-2029-000 LPE22V LPE22VA	1210-2033-000 LPE16SA LPE16VA				2504-2036-001 LPE22VA
SHUTTER		 <p align="center">LPEV</p>  <p align="center">LPES</p>			
					
2644 LPE12S LPE12SA	3538 LPE30S LPE30SA				
2649 LPE16S LPE16SA					
3534 LPE24S LPE24SA					

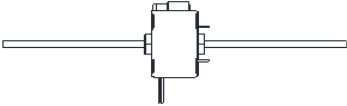
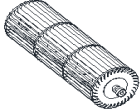
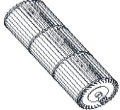
BE SERIES COMMERCIAL BELT DRIVE EXHAUST FAN

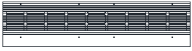
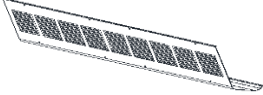
BLADE				
				
8528-8147 BE24	8528-8148 BE30	8528-8149 BE36	1210-2025-001 BE42	1016-0044-001 BE48
MOTOR		SHAFT-ARBOR	BELT	
				
3900-2068-000 BE24 BE30 BE36 BE42	517-083 BE48	5217-2006-000 BE24 BE30 BE36 BE42	9707-8053 BE24	9707-8055 BE30
			1230-0003-000 BE36	4280 BE42
PULLEY FAN	PULLEY MOTOR		BEARING (2 REQ)	
				
4436 BE24	612-019 BE24	4434 BE30	8526-8006 BE24 BE30 BE36 BE42	
1064 BE30 BE36	4507-2009-000 BE36	2594 BE42 BE48		
1804 BE42 BE48				

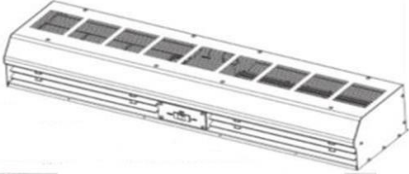

MLP LOW-PROFILE SERIES					
MOTOR		BLOWER WHEEL RIGHT		BLOWER WHEEL LEFT	
					
3900-2090-000 MLP36001115GA MLP3600115GR MLP36001115GRSS MLP42001110GA MLP42001110GR MLP42001110GRSS MLP48001108GA MLP48001108GR MLP48001108GRSS MLP60001108GA MLP60001108GR MLP60001108GRSS	3900-2093-001 MLP36001208GA MLP36001208GR MLP36001208GRSS MLP42001208GA MLP42001208GR MLP42001208GRSS MLP48001206GA MLP48001206GR MLP48001206GRSS MLP60001206GA MLP60001206GR MLP60001206GRSS	1225-2024-000 MLP36001115GA MLP3600115GR MLP36001115GRSS MLP36001208GA MLP36001208GR MLP36001208GRSS 1225-2024-001 MLP42001110GA MLP42001110GR MLP42001110GRSS MLP42001208GA MLP42001208GR MLP42001208GRSS	1225-2024-002 MLP48001108GA MLP48001108GR MLP48001108GRSS MLP48001206GA MLP48001206GR MLP48001206GRSS 1225-2024-003 MLP60001108GA MLP60001108GR MLP60001108GRSS MLP60001206GA MLP60001206GR MLP60001206GRSS	1225-2025-000 MLP36001115GA MLP3600115GR MLP36001115GRSS MLP36001208GA MLP36001208GR MLP36001208GRSS 1225-2025-001 MLP42001110GA MLP42001110GR MLP42001110GRSS MLP42001208GA MLP42001208GR MLP42001208GRSS	1225-2025-002 MLP48001108GA MLP48001108GR MLP48001108GRSS MLP48001206GA MLP48001206GR MLP48001206GRSS 1225-2025-003 MLP60001108GA MLP60001108GR MLP60001108GRSS MLP60001206GA MLP60001206GR MLP60001206GRSS
CORD		GRILLE			SWITCH
					
1420-2038-004 MLP36001115GA MLP3600115GR MLP36001115GRSS MLP42001110GA MLP42001110GR MLP42001110GRSS MLP48001108GA MLP48001108GR MLP48001108GRSS MLP60001108GA MLP60001108GR MLP60001108GRSS	1420-2044-001 MLP36001208GA MLP36001208GR MLP36001208GRSS MLP42001208GA MLP42001208GR MLP42001208GRSS MLP48001206GA MLP48001206GR MLP48001206GRSS MLP60001206GA MLP60001206GR MLP60001206GRSS	1809-2033-800 MLP36001115GA MLP36001208GA 1809-2033-801 MLP42001110GA MLP42001208GA 1809-2033-802 MLP48001108GA MLP48001206GA 1809-2033-803 MLP60001108GA MLP60001206GA	2501-2090-900 MLP3600115GR MLP36001208GR 2501-2090-901 MLP42001110GR MLP42001208GR 2501-2090-902 MLP48001108GR MLP48001206GR 2501-2090-903 MLP60001108GR MLP60001206GR	2501-2090-200 MLP36001115GRSS MLP36001208GRSS 2501-2090-201 MLP42001110GRSS MLP42001208GRSS 2501-2090-202 MLP48001108GRSS MLP48001206GRSS 2501-2090-203 MLP60001108GRSS MLP60001206GRSS	790-188 ALL MODELS
Low-Profile - Contemporary Series 		Low-Profile - Architectural Series 			

ENVIRONMENTAL SERIES AIR CURTAINS

MOTOR BLOWER ASY

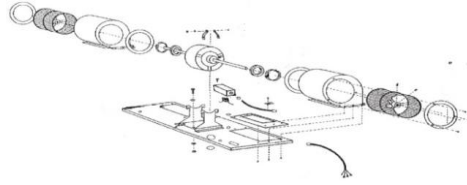

ACMB125	ACMB225	ACMB300		ACMB305	ACMB325	ACMB350	ACMB600	
E36001125	E36001225	E36001300	E84002300	E36001305	E36001325	E36001350	E36001675	
E38001125	E38001225	E36001375	E84002375	E36001405	E36001425	E36001450	E42001675	
E42001125	E42001225	E36001400	E84002400	E36001505	E36001525	E36001550	E60001675	
E48001125	E48001225	E36001475	E84002475	E38001305	E38001325	E38001350	E96002675	
E72002125	E60001225	E36001500	E84002500	E38001405	E38001425	E38001450	E10803675	
E76002125	E72002225	E36001575	E84002575	E38001505	E38001525	E38001550	ACMB650	
E84002125	E76002225	E38001300	E96002300	E42001305	E42001325	E42001350	E72002650	
E96002125	E84002225	E38001375	E96002375	E42001405	E42001425	E42001450	E10803650	
E10803125	E96002225	E38001400	E96002400	E42001505	E42001525	E42001550	ACMB125D	
E12003125	E10803225	E38001475	E96002475	E48001305	E48001325	E48001350	E60002125	
E13203125	E12003225	E38001500	E96002500	E48001405	E48001425	E48001450	ACMB150D	
E14403125	E13203225	E38001575	E96002575	E48001505	E48001525	E48001550	E60002150	
	E14403225	E42001300	E10803300	E60001305	E72002325	E72002350	ACMB225D	
ACMB150		E42001375	E10803375	E60001405	E72002425	E72002450	E60002225	
E36001150	ACMB250	E36001400	E10803400	E60001505	E72002525	E72002550	ACMB250D	
E38001150	E36001250	E42001400	E10803400	E72002305	E76002325	E76002350	E60002250	
E42001150	E38001250	E42001475	E10803475	E72002405	E76002425	E76002450	ACMB325D	
E48001150	E42001250	E42001475	E10803500	E72002405	E76002425	E76002450	E60002325	
E60001150	E48001250	E42001575	E10803575	E72002505	E76002525	E76002550	E60002425	
E72002150	E60001250	E48001300	E12003300	E76002305	E84002325	E84002350	E60002425	
E76002150	E72002250	E48001375	E12003375	E76002405	E84002425	E84002450	E60002525	
E84002150	E76002250	E48001400	E12003400	E76002505	E84002525	E84002550	ACMB350D	
E96002150	E84002250	E48001475	E12003475	E84002305	E84002325	E84002350	E96002350	
E10803150	E96002250	E48001500	E12003500	E84002405	E96002425	E96002450	E96002450	
E12002150	E10803250	E48001575	E12003575	E84002505	E96002525	E96002550	E60002350	
E12003150	E12003250	E60001300	E13203300	E96002305	E10803325	E10803350	E60002450	
E13203150	E13203250	E60001375	E13203375	E96002405	E10803425	E10803450	E60002550	
E14403150	E14403250	E60001400	E13203400	E96002505	E10803525	E10803550		
		E60001475	E13203475	E10803305	E12003325	E12003350		
ACMB175	ACMB275	E60001500	E13203500	E10803405	E12003425	E12003450		
E36001175	E36001275	E60001575	E13403575	E10803505	E12003525	E12003550		
E38001175	E38001275	E72002300	E14403300	E12003305	E13203325	E13203350		
E42001175	E42001275	E72002375	E14403375	E12003405	E13203425	E13203450		
E48001175	E48001275	E72002400	E14003400	E12003505	E13203525	E13403550		
E60001175	E60001275	E72002475	E14403475	E13203305	E14403325	E14403350		
E72002175	E72002275	E72002500	E14403500	E13203405	E14403425	E14403450		
E76002175	E76002275	E72002575	E14403575	E13203505	E14403525	E14403550		
E84002175	E84002275	E76002300		E14403305				
E96002175	E96002275	E76002375		E14403405				
E10803175	E10803275	E76002400		E14403505				
E12002175	E12003275	E76002475						
E12003175	E13203275	E76002500						
E13203175	E14403275	E76002575						
E14403175		E76002675						
		E76002750						
		E76002750						
WIRE HARNESS	GRILLE KNURLED NUT	ROCKER SWITCH						
	PICTURE NOT AVAILABLE							
ACWS616	AP0002	C1220						
ALL MODELS	ALL MODELS	E36001125	E60001175	E84002275	E13203250			
		E36001150	E60001225	E96002125	E13203275			
		E36001175	E60001250	E96002150	E14403125			
		E36001225	E60001275	E96002175	E14403150			
		E36001250	E60002125	E96002225	E14403175			
		E36001275	E60002150	E96002250	E14403225			
CABINET ASY		E38001125	E60002225	E96002275	E14403250			
1016-0096-000	36"	E38001150	E60002250	E10803125	E14403275			
1016-0096-001	38"	E38001175	E72002125	E10803150				
1016-0096-002	42"	E38001225	E72002150	E10803175				
1016-0096-003	48"	E38001250	E72002175	E10803225				
1016-0096-004	60"	E38001275	E72002225	E10803250				
1016-0096-005	60" DUALY	E42001125	E72002250	E10803275				
		E42001150	E72002275	E12002150				
		E42001175	E76002125	E12002175				
		E42001225	E76002150	E12003125				
		E42001250	E76002175	E12003150				
		E42001275	E76002225	E12003175				
		E48001125	E76002250	E12003225				
GRILLE ASY		E48001150	E76002275	E12003250				
1016-0093-000	36"	E48001175	E84002125	E12003275				
1016-0093-001	38"	E48001225	E84002150	E13203125				
1016-0093-002	42"	E48001250	E84002175	E13203150				
1016-0093-003	48"	E48001275	E84002225	E13203175				
1016-0093-004	60"	E60001150	E84002250	E13203225				



NOTE

5TH DIGIT IN MODEL NUMBER DETERMINS MOTOR AND WIRE HARNESS QTY.

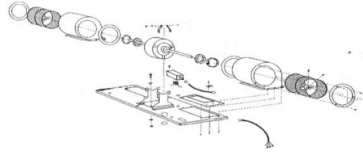

HIGH VELOCITY SERIES AIR CURTAINS

MOTOR BLOWER ASY





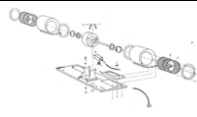

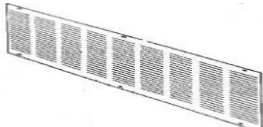
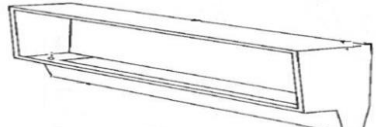

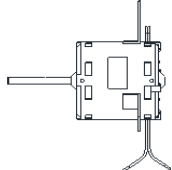
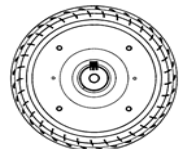
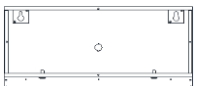

ACMB300		ACMB305		ACMB330											
EL36001300LI	EL76002500LI	EL36001305LI	EL76002505LI	EL36001330LI	EL76002530LI										
EL36001400LI	EL84002300LI	EL36001405LI	EL84002305LI	EL36001430LI	EL84002330LI										
EL36001500LI	EL84002400LI	EL36001505LI	EL84002405LI	EL36001530LI	EL84002430LI										
EL38001300LI	EL84002500LI	EL38001305LI	EL84002505LI	EL38001330LI	EL84002530LI										
EL38001400LI	EL96002300LI	EL38001405LI	EL96002305LI	EL38001430LI	EL96002330LI										
EL38001500LI	EL96002400LI	EL38001505LI	EL96002405LI	EL38001530LI	EL96002430LI										
EL42001300LI	EL96002500LI	EL42001305LI	EL96002505LI	EL42001330LI	EL96002530LI										
EL42001400LI	EL10803300LI	EL42001405LI	EL10803305LI	EL42001430LI	EL10803330LI										
EL42001500LI	EL10803400LI	EL42001505LI	EL10803405LI	EL42001530LI	EL10803430LI										
EL48001300LI	EL10803500LI	EL48001305LI	EL10803505LI	EL48001330LI	EL10803530LI										
EL48001400LI	EL12003300LI	EL48001405LI	EL12003305LI	EL48001430LI	EL12003330LI										
EL48001500LI	EL12003400LI	EL48001505LI	EL12003405LI	EL48001530LI	EL12003430LI										
EL60001300LI	EL12003500LI	EL60001305LI	EL12003505LI	EL60001330LI	EL12003530LI										
EL60001400LI	EL13203300LI	EL60001405LI	EL13203305LI	EL60001430LI	EL13203330LI										
EL60001500LI	EL13203400LI	EL60001505LI	EL13203405LI	EL60001530LI	EL13203430LI										
EL72002300LI	EL13203500LI	EL72002305LI	EL13203505LI	EL72002330LI	EL13203530LI										
EL72002400LI	EL14403300LI	EL72002405LI	EL14403305LI	EL72002430LI	EL14403330LI										
EL72002500LI	EL14403400LI	EL72002505LI	EL14403405LI	EL72002530LI	EL14403430LI										
EL76002300LI	EL14403500LI	EL76002305LI	EL14403505LI	EL76002330LI	EL14403530LI										
EL76002400LI		EL76002405LI		EL76002430LI											
ACMB600 EL36001600LI EL60001600LI EL72002600LI EL96002600LI EL10803600LI		ACMB605 EL96002605LI EL12003605LI		ACMB630 EL96002630LI EL10803630LI EL12003630LI EL14403630LI											
CABINET ASY		WIRE HARNESS													
<table style="width: 100%; border-collapse: collapse;"> <tr> <td style="width: 80%;">1016-0096-000</td> <td style="width: 20%;">36"</td> </tr> <tr> <td>1016-0096-001</td> <td>38"</td> </tr> <tr> <td>1016-0096-002</td> <td>42"</td> </tr> <tr> <td>1016-0096-003</td> <td>48"</td> </tr> <tr> <td>1016-0096-004</td> <td>60"</td> </tr> </table>		1016-0096-000	36"			1016-0096-001	38"	1016-0096-002	42"	1016-0096-003	48"	1016-0096-004	60"	ACW5614 ALL MODELS	
1016-0096-000	36"														
1016-0096-001	38"														
1016-0096-002	42"														
1016-0096-003	48"														
1016-0096-004	60"														
GRILLE ASY		NOTE		5TH DIGIT IN MODEL NUMBER DETERMINS MOTOR AND WIRE HARNESS QTY.											
<table style="width: 100%; border-collapse: collapse;"> <tr> <td style="width: 80%;">1016-0093-000</td> <td style="width: 20%;">36"</td> </tr> <tr> <td>1016-0093-001</td> <td>38"</td> </tr> <tr> <td>1016-0093-002</td> <td>42"</td> </tr> <tr> <td>1016-0093-003</td> <td>48"</td> </tr> <tr> <td>1016-0093-004</td> <td>60"</td> </tr> </table>		1016-0093-000	36"	1016-0093-001	38"	1016-0093-002	42"	1016-0093-003	48"	1016-0093-004	60"				
1016-0093-000	36"														
1016-0093-001	38"														
1016-0093-002	42"														
1016-0093-003	48"														
1016-0093-004	60"														

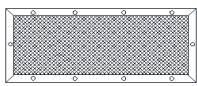
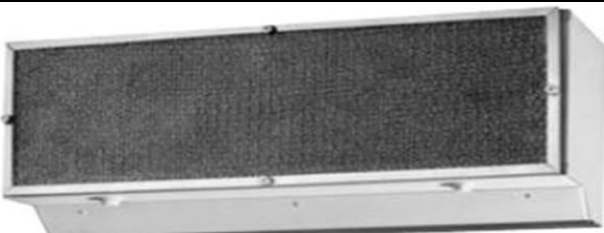
SINGLE PHASE ENVIRONMENTAL SERIES ELECTRICALLY HEATED

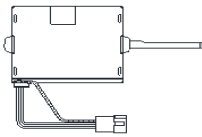
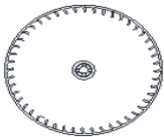

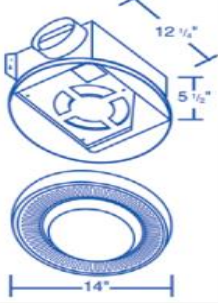

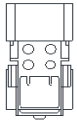
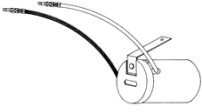
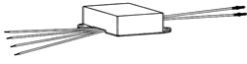

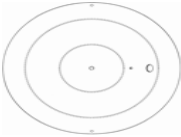
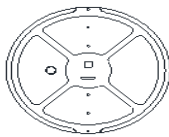

MOTOR BLOWER ASY	ELEMENT		THERMOSTAT	CABINET ASY	
	PICTURE NOT AVAILABLE				
ACMB125 ALL MODELS	APHE06240-1 E36061125H E42061125H E48061125H	APHE09240-1 E36091125H E42091125H E48091125H	T8775C1005 ALL MODELS		
GRILLE ASY			CABINET ASY		
					
1016-0093-000 E36061125H E36091125H	1016-0093-002 E42061125H E42091125H	1016-0093-003 E48061125H E48091125H	1016-0096-000 E36061125H E36091125H	1016-0096-002 E42061125H E42091125H	1016-0096-003 E48061125H E48091125H

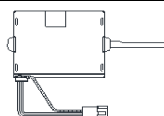
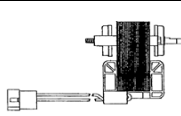
24" DRIVE-THRU WINDOW UNIT

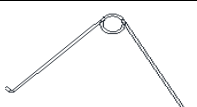



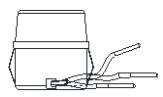
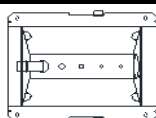

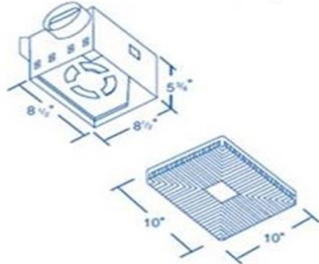
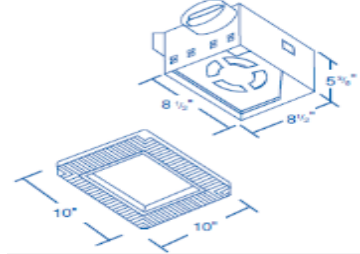





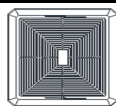

MOTOR (2 REQ)	IMPELLER (2 REQ)	CABINET	GRILLE	FILTER
				
3900-2069-000 E24001115F E24001115FG E24001115FHW E24001115G	8710-8022 E24001115F E24001115FG E24001115FHW E24001115G	1016-0109-000 E24001115F E24001115FG E24001115FHW E24001115G	2501-2066-000 E24001115F E24001115FG E24001115FHW E24001115G	2010-7009-028 E24001115F E24001115FHW 2010-7009-029 E24001115FG
				



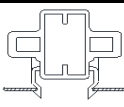
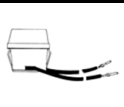

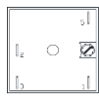
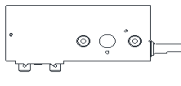
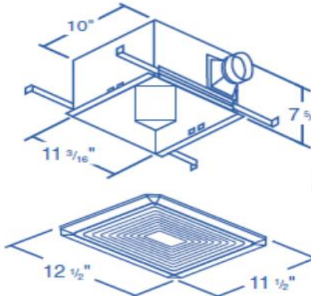

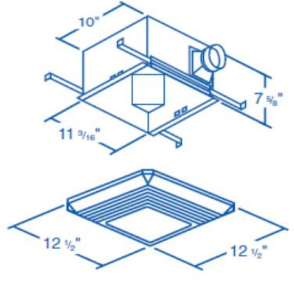

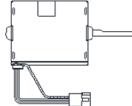
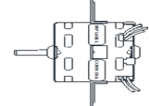
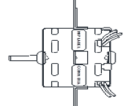

1001 SERIES				
MOTOR	IMPELLER	GRILLE		LENS
				
7163-9763 1001 1001F 1001BR	8710-8023 1001 1001F 1001BR	357-114-W 1001 1001F	357-114-OP 1001BR	460-011-W 1001 1001F 1001BR
LAMP HOLDER			BALLAST ASY	
				
3519-11005-000 1001	8695-8098 1001F	8695-8101 1001BR	6104-8020 1001F	
DUCT ADAPTER	REFLECTOR ASY		GRILLE SPRING (2 REQ)	
				
991-613 1001 1001F 1001BR	8826-8044 1001 1001BR	630-063 1001F	733-218 1001 1001F 1001BR	

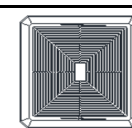
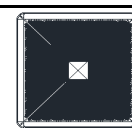
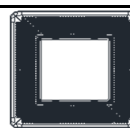
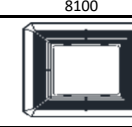
6000 SERIES

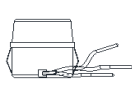
MOTOR				GRILLE	
					
7163-9763 6100 6100L 6100RL	7173-0174 6080 6080L 6080RL	8767-8238 6060 6060L 6060RL	991-688 6060 6080 6100	991-689 6060L 6080L 6100L	1016-0077-000 6060RL 6080RL 6100RL
IMPELLER		GRILLE SPRING (2 REQ)		DUCT ADAPTER	
					
8710-8021 6060 6060L 6060RL	8710-8023 6080 6080L 6080RL 6100 6100L 6100RL	733-218 6060 6060L 6060RL 6080 6080L		991-613 6060 6060L 6060RL 6080 6080L	
6080RL 6100		6100L 6100RL		6100L 6100RL	
LENS		LAMP HOLDER	REFLECTOR ASY		
					
8738-8017 6060L 6080L 6100L	3508-2003-000 6060RL 6080RL 6100RL	3519-0004-000 6060L 6060RL 6080L 6080RL 6100L 6100RL	991-591 6060L 6060RL 6080L 6080RL 6100L 6100RL		
  					

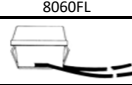



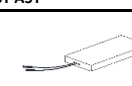

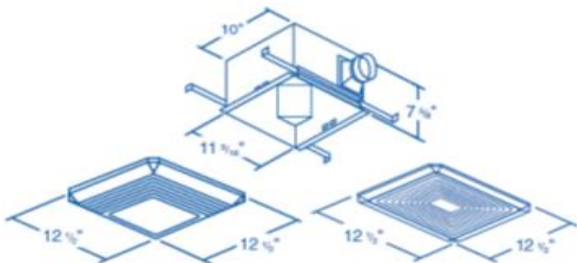

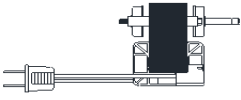
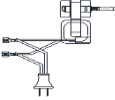

7100 SERIES

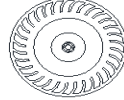
MOTOR		IMPELLER		GRILLE		GRILLE SPRINGS (2 REQ)		
								
GM7100 7100 7100A 7100FL 7100FLH 7100H 7100HA 7100L 7100LA 7100LH	GM7150 7150 7150A 7150FL 7150FLH 7150H 7150HA 7150L 7150LA 7150LH	8710-8017 7100 7100A 7100FL 7100FLH 7100H 7100HA 7100L 7100LA 7100LH		7150 7150A 7150FL 7150FLH 7150H 7150HA 7150L 7150LA 7150LH	991-611-W 7100 7100A 7100H 7100HA 7150 7150HA	991-608-W 7100FL 7100FLH 7100L 7100LA 7100LH 7150FL 7150FLH 7150H 7150L 7150LA 7150LH	733-218 ALL MODELS	
DUCT ADAPTER			LENS		LAMP HOLDER			
								
1016-0091-000 7100A 7100LA 7150A 7150LA		991-613 7100 7100FL 7100FLH 7100H 7100HA 7100L 7100LH		7150 7150FL 7150FLH 7150H 7150HA 7150L 7150LH	8738-8017 7100FL 7100FLH 7100L 7100LH 7150FL 7150FLH 7150L 7150LH	3508-2003-000 7100LA 7150LA	8695-8097 7100FL 7100FLH 7150FL 7150FLH	8504-8476 7100L 7100LA 7100LH 7150L 7150LA 7150LH
REFLECTOR ASY		BALLAST ASY		TIMER	HUMIDISTAT	NOTES		
						GM7100 AND GM7150 MOTOR/BLOWER ASSY INCLUDES IMPELLER AND MOTOR BRACKET		
8826-8040 7100L 7100LA 7100LH 7150L 7150LA 7150LH	5007-2023-000 7100FL 7100FLH 7150FL 7150FLH	1228-2002-000 7100FL 7100FLH 7150FL 7150FLH	1414-2031-000 7100FLH 7100HA 7150FLH 7150HA	1414-2032-000 7100FLH 7100HA 7150FLH 7150HA				
								

8000 SERIES					
MOTOR					
					
3900-2066-000 8090 8090A 8090L 8090LA	3900-2091-000 8060ES 8060ESA 8060FL 8060FLA 8060FLE			3900-2092-000 8080ES 8080FL 8080FLA 8080FLE 8140A	GM7100 8100 8100A 8100L 8100LA
CAPACITOR			GRILLE		
					
1432-2007-000 8060ES 8060ESA 8060FL 8060FLA 8060FLE 8080ES 8080FL 8080FLA 8080FLE			8100ES 8100ESA 8100ESH 8100ESHA 8100FL 8100FLA 8100FLE 8100FLH 8100FLHA	8100FLHE 8140A 8140ES 8140EAS 8140FL 8140FLA 8140FLE 8140LA	991-611-W 8090 8100  991-608-W 8090L 8100L
1016-0137-000 8060ES 8060ESA 8080ES 8090A 8100A 8100ES 8100ESA 8100ESH 8100ESHA 8140A 8140ES 8140EAS			8060FL 8060FLA 8060FLE 8080FL 8080FLA 8080FLE 8100FL 8100FLA 8100FLE 8100FLH 8100FLHA	8060FL 8060FLA 8060FLE 8080FL 8080FLA 8080FLE 8090LA 8100FL 8100FLA 8100FLE 8100FLH 8100FLHA	1016-0136-000 8100FLHE 8100LA 8140FL 8140FLA 8140FLE 8140LA
LENS		LAMP HOLDER		REFLECTOR ASY	TIMER
					
8738-8017 8060FL 8060FLA 8060FLE 8080FL 8080FLA 8080FLE 8090L 8090LA 8100FL 8100FLA		8100FLE 8100FLH 8100FLHA 8100FLHE 8100L 8100LA 8140FL 8140FLA 8140LA		3519-0004-000 8060FL  8504-8476 8090LA 8100LA	3519-11001-000 8060FLA 8060FLE 8080FLA 8080FLE 8100FLA 8100FLE 8100FLHA 8100FLHE 8140FLA 8140FLE 8140LA
8695-8097 8080FL 8100FL 8100FLH 8140FL		8826-8040 8060FL 8090L 8090LA 8100L 8100LA 5007-2023-000 8080FL 8100FL 8100FLH 8140FL		1414-2031-000 8100ESH 8100ESHA 8100FLH 8100FLHA 8100FLHE	
HUMIDISTAT	GRILLE SPRING (2 REQ)	DUCT ADAPTER	IMPELLER	BALLAST ASY	NOTES
					GM7100 IS MOTOR/BLOWER ASSY INCLUDES IMPELLER AND MOTOR BRACKET
1414-2032-000 8100ESH 8100ESHA 8100FLH 8100FLHA 8100FLHE	733-218 ALL MODELS	1016-0091-000 ALL MODELS	8710-8017 ALL MODELS	1228-2002-000 8060FL 8060FLA 8060FLE 8080FL 8080FLA 8080FLE 8100FL 8100FLH 8140FL	
				1016-11056-000 8100FLA 8100FLE 8100FLHA 8140FLA 8140FLE 8140LA	

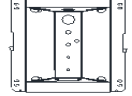
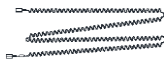



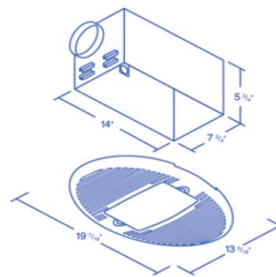

COMBINATION FANS MM698 & MM728NL

MOTOR (EXHAUST)		MOTOR (HEAT)	FAN	IMPELLER		DUCT ADAPTER
						
3900-2049-000 MM728 MM728NL	8767-8130 MM698 MM698A MM698F MM698AF MM698WC MM698WCA	3900-2076-000 MM698 MM698A MM698F MM698AF MM698WC MM698WCA MM728 MM728NL	8528-8052 MM698 MM698A MM698F MM698AF MM698WC MM698WCA MM728 MM728NL	8710-8016 MM698 MM698A MM698F MM698AF MM698WC MM698WCA	313-076 MM728 MM728NL	991-614 MM698 MM698A MM698F MM698AF MM698WC MM698WCA MM728 MM728NL
GRILLE		LENS	REFLECTOR ASY			ELEMENT
						
1016-0080-000 MM698 MM698A MM698WC MM698WCA MM728 MM728NL	1016-0082-000 MM698F MM698AF	3508-2002-000 MM698 MM698A MM698F MM698AF MM698WC MM698WCA MM728 MM728NL	630-065 MM698 MM698A MM698WC MM698WCA MM728	630-068 MM698F MM698AF	5007-2024-000 MM728NL	991-497 MM698 MM698A MM698F MM698AF MM698WC MM698WCA MM728 MM728NL
LAMP HOLDER			WALL SWITCH		BALLAST ASY	
						
8695-8097 MM698F MM698AF	8504-8476 MM728NL	398-051 MM698 MM698A MM698WC MM698WCA MM728	8587-0003A MM698WC MM698WCA	8587-8229 MM728 MM728NL	1228-2002-000 MM698F MM698AF	

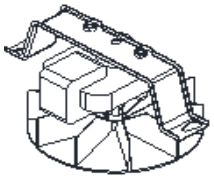
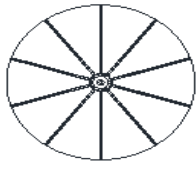
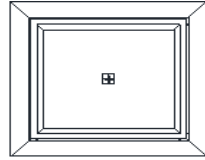
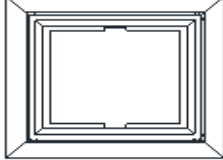

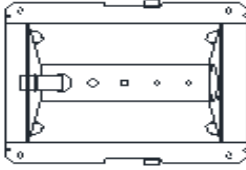



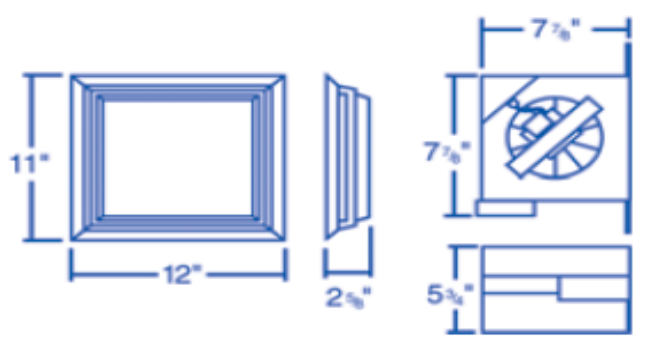
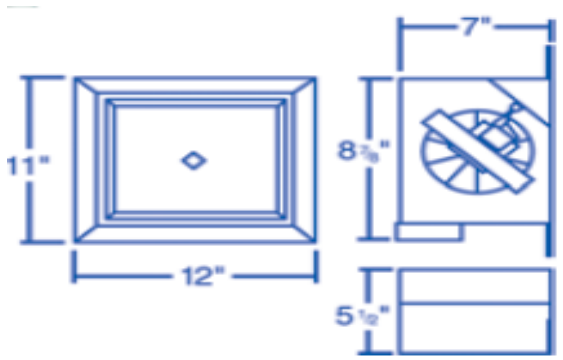





DUCTLESS BATH FANS 645 & 646



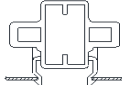
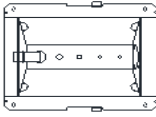

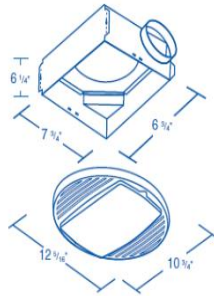

MOTOR	IMPELLER	GRILLE	
			
GM50 645 646	8710-8016 645 646	991-337-W 645	357-089-W 646
LAMP HOLDER	REFLECTOR ASY	LENS	FILTER
			PICTURE NOT AVAILABLE
398-051 646	8826-8039 646	460-010-W 646	8663-8052 645 646



ECONOMY BATH FAN/LIGHT MM6641C, MM6671C & MM6671CF

MOTOR		IMPELLER	GRILLE	LENS	DUCT ADAPTER
					
GM50 MM6641C	GM70 MM6671C MM6671CF	8710-8016 MM6641C MM6671C MM6671CF	357-106-W MM6641C MM6671C MM6671CF	3508-2002-000 MM6641C MM6671C MM6671CF	991-615 MM6641C MM6671C MM6671CF
LAMP HOLDER		REFLECTOR ASY		BALLAST ASY	NOTES
					GM50 & GM70 MOTOR/BLOWER ASSY INCLUDES IMPELLER AND MOTOR BRACKET
398-051 MM6641C MM6671C	8695-8097 MM6671CF	991-600 MM6641C MM6671C	630-067 MM6671CF	1228-2002-000 MM6671CF	
					

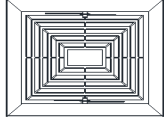
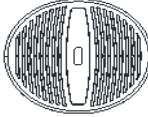
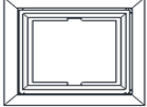
ECONOMY QUICK MOUNT SERIES A647, A664IC, MM647, MM648, AND MM748

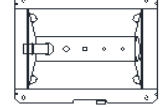
MOTOR		IMPELLER	DUCT ADAPTER		LAMP HOLDER
					
GM50 A647 A647A A647B A664IC MM647 MM647B MM648	GM70 MM748 MM748H	8710-8016 A647 A647A A647B A664IC MM647 MM647B MM648 MM748 MM748H	991-630 A647 A647A A647B MM647 MM647B MM648	991-615 A664IC MM748 MM748H	398-051 A664IC
GRILLE		LENS	GRILLE SPRING (2 REQ)	REFLECTOR ASY	
					
991-616-W A647 A647A A647B	2501-2053-000 MM647 MM647B MM648 MM748 MM748H	357-116-W A664IC	460-010-W A664IC	733-218 A647 A647A A647B MM647 MM647B MM648 MM748 MM748H	8826-8039 A664IC





NOTE: GM50 & GM70 INCLUDE MOTOR/IMPELLER AND BRACKET

FIRE RATED VENTILATORS

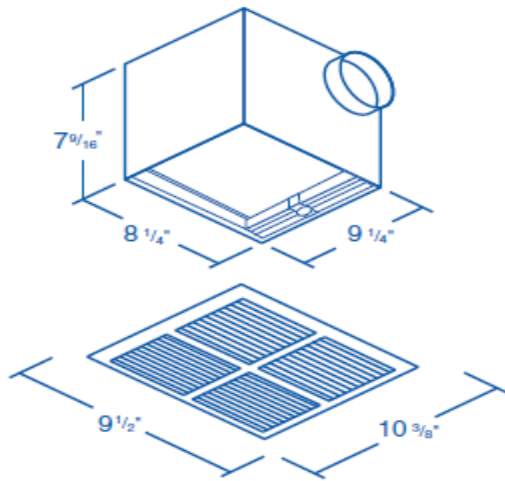



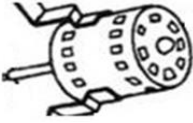
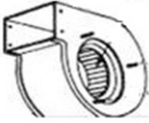
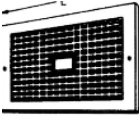





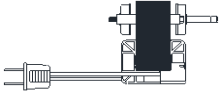
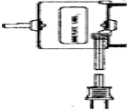

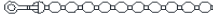
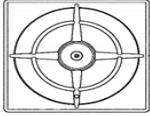
MOTOR/BLOWER ASY			LIMIT	GRILLE
PICTURE NOT AVAILABLE			PICTURE NOT AVAILABLE	PICTURE NOT AVAILABLE
Z650FRD 650FRD	Z680FRD 680FRD	Z610FRD 610FRD	FL165 650FRD 680FRD 610FRD	2501-2064-000 650FRD 680FRD 610FRD

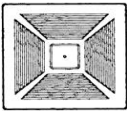

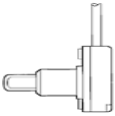
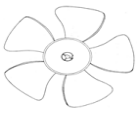
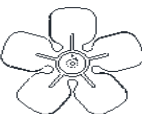
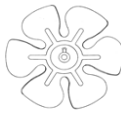



SUPER Q VENTILATORS

MOTOR		IMPELLER		
				
56343-0 CV6	56346-0 CV10	56334-0 CV6	56335-0 CV8 CV81 CV101 CV12	56367-0 CV10
56344-0 CV8	56347-0 CV101			
56345-0 CV81	56350-0 CV12			
GRILLE				GRILLE SPRING (2 REQ)
				<p style="font-size: 1.2em; margin: 0;">PICTURE NOT AVAILABLE</p>
55130-1 CV6	55131-1 CV8 CV81	55132-1 CV10	55133-1 CV101 CV12	56327-0 CV6 CV8 CV81 CV10 CV101 CV12
				



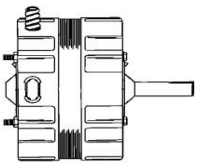
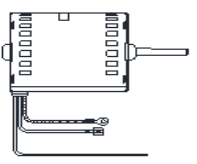
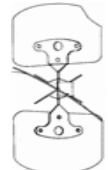
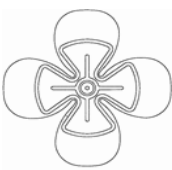
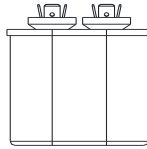
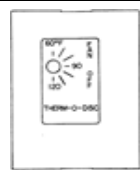
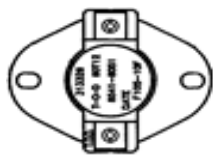



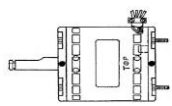
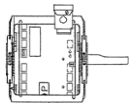
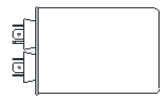
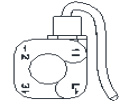

GENERAL HOME / KITCHEN FANS

MOTOR		GRILLE KNOB		CHAIN	
					
8767-8232 898L 899L	8767-8233 790L 760L	7163-9672 1047 1080	6412-8023 790L	0899-0008 898L 899L 1047 760L 1080	
GRILLE				CONTROL KNOB	SWITCH
					
8683-8323 1047 8683-8308 1080	8683-8062 790L*	8683-8295 790L** 898L 760L	8683-8320 899L	3301-2039-000 790L	0810-0288 899L 1047
FAN				NOTES	
			* FRONT GRILLE 790L ** REAR GRILLE 790L		
8528-8026 898L 899L	8528-8152 1047 1080	8528-8075 790L			
					
790L	898L	899L			
					
1047	760L	1080			

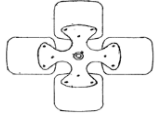
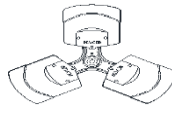
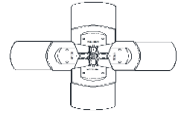
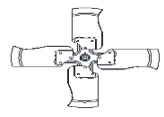
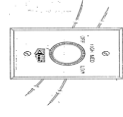

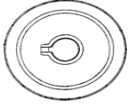
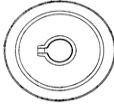

ATTIC VENTILATORS







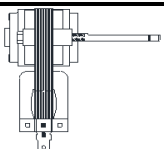

MOTOR		FAN BLADE	
			
8767-8241 RV16 GV16	7163-9739 ASRV14 AGV14	8528-8041 RV16	8528-8142 ASRV14 AGV14
		8528-8118 GV16	
CAPACITOR	THERMOSTAT		
			
6100-8036 RV16 GV16	1230-8192 RV16 GV16	8541-8051 ASRV14 AGV14	
			
RV16	ASRV14	AGV14 & GV16	

WHOLE HOUSE FANS

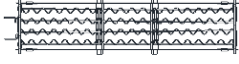
MOTOR		CAPACITOR		SWITCH	SHUTTER
					
7126-3441 A20DD	7126-3436 2438	1432-0002-001 A20DD	6100-8039 A24DD	5216-2059-000 A20DD	8862-8039 A20DD
7126-3438 A24DD	7126-3439 3038R 7126-3440 3638R	1432-0002-004 2438 3038R	6100-8026 3638R		
FAN BLADE				CONTROL ASY	SHAFT
					
8528-8069 A20DD	8528-8150 A24DD 8528-8147 2438	8528-8148 3038R	8528-8149 3638R	8587-8129 A24DD 2438 3038R 8587-8133 3638R	8856-8014 2438 3038R 3638R
MOTOR SHEAVE	FAN SHEAVE		V-BELT	 2438, 3038R & 3638R	
			PICTURE NOT AVAILABLE		
8944-8024 2438	8944-8025 2438	8944-8026 3038R	9707-8053 2438		
8944-8023 3038R		8944-8027 3638R	9707-8054 3038R		
8944-8022 3638R			9707-8055 3638R		
					
A20DD		A24DD			

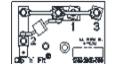

MFA SERIES (OBS)



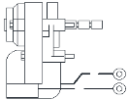
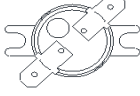

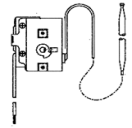
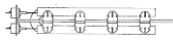
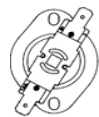
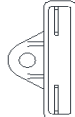
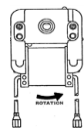

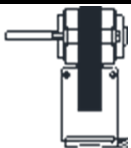
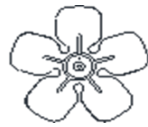

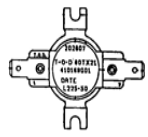
ELEMENTS					LIMIT		
							
1802-2021-000		1802-2021-003	1802-2021-004		4520-2023-000		
A1000IF	A1500IF	A1504IF	A1004IF	A2004T2B	A1000IF	A1500IFBNW	A2004IFB
A1000IFA	A1500IFA	A1504IFA	A1004IFA	A2004T2BNW	A1000IFB	A1500T	A2004IFBNW
A1000IFB	A1500IFB	A1504IFB	A1004IFB	A2404IF	A1000IFBNW	A1500T2B	A2004T
A1000IFBNW	A1500IFBNW	A1504IFBNW	A1004IFBNW	A2404IFA	A1000T	A1500T2BNW	A2004T2B
A1000T	A1500T	A1504T	A2004IF	A2404IFB	A1000T2B	A1504IF	A2004T2BNW
A1000TA	A1500TA	A1504TA	A2004IFA	A2404IFBNW	A1000T2BNW	A1504IFB	A2404IF
A1000T2	A1500T2	A1504T2	A2004IFB	A2404T	A1004IF	A1504IFBNW	A2404IFB
A1000T2B	A1500T2B	A1504T2B	A2004IFBNW	A2404TA	A1004IFB	A1504T	A2404IFBNW
A1000T2BNW	A1500T2BNW	A1504T2BNW	A2004T	A2404T2	A1004IFBNW	A1504T2B	A2404T
			A2004TA	A2404T2B	A1500IF	A1504T2BNW	A2404T2B
			A2004T2	A2404T2BNW	A1500IFB	A2004IF	A2404T2BNW
MOTOR					THERMOSTAT		
							
3900-2017-000		3900-2017-001			5813-2001-000	5813-2015-000	
A0500IFA	A1000T2	A0504IFA	A1504IF	A2004TA	A0504TA	A0504T2	A1500T2BNW
A0500IFB	A1000T2B	A0504IFB	A1504IFA	A2004T2	A1000T	A0504T2B	A1504T2B
A0500IFBNW	A1000T2BNW	A0504IFBNW	A1504IFB	A2004T2B	A1000TA	A0504T2BNW	A1504T2BNW
A0750IFA	A1500IF	A0504TA	A1504IFBNW	A2004T2BNW	A1500T	A1000T2	A2004T2
A0750IFB	A1500IFA	A0504T2	A1504T	A2404IF	A1500TA	A1000T2B	A2004T2B
A0750IFBNW	A1500IFB	A0504T2B	A1504TA	A2404IFA	A1504T	A1000T2BNW	A2004T2BNW
A1000IF	A1500IFBNW	A0504T2BNW	A1504T2	A2404IFB	A1504TA	A1500T2	A2404T2B
A1000IFA	A1500T	A0754IFA	A1504T2B	A2404IFBNW	A1504T2	A1500T2B	A2404T2BNW
A1000IFB	A1500TA	A0754IFB	A1504T2BNW	A2404T	A2004T		
A1000IFBNW	A1500T2	A0754IFBNW	A2004IF	A2404TA	A2004TA		
A1000T	A1500T2B	A1004IF	A2004IFA	A2404T2	A2404T		
A1000TA	A1500T2BNW	A1004IFA	A2004IFB	A2404T2B	A2404TA		
		A1004IFB	A2004IFBNW	A2404T2BNW	A2404T2		
		A1004IFBNW	A2004T				

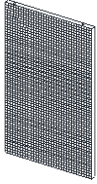

CRA SERIES										
KNOB		GRILLE	LIGHT				ELEMENT			
										
3301-2039-002		2501-2065-000	3510-2017-000	3510-2017-001	3510-2017-002	3510-2017-003	1802-2124-005	1802-2124-000	1802-2124-003	
C1012T2 C1024T2 C1512T2 C1524T2 C2024T2 C2028T2 C2224T2 C1012T2A C1024T2A C1512T2A C1524T2A C2024T2A C2028T2A C2224T2A	C1012T2AA C1512T2AA C1012T2AB C1024T2AB C1512T2AB C1524T2AB C2024T2AB C2028T2AB C1524T2AB C2024T2AB C2224T2AB C1512T2B C1524T2B C2024T2B C2224T2B C1512T2C C2024T2C C2224T2C	C1512IFB C1512T2B C2024IFB C2024T2B C2028IFB C2224IFB C1512IFC C1512T2A C1512T2C C2024IFC C2224T2C C1512IFA C1012T2A C1512IFA C2024T2C C2028IFC C2224IFC C2224T2C	C1012IF C1012T2 C1512IF C1512T2 C1012IFA C1012T2A C1512IFA C1012FAA C1012T2AA C1512IFA C1512T2AA C1024T2A C1524IFA C1524T2A C2024IFA C2024T2A C2028IFA C2028T2A C2224IFA C2224T2A	C1024IF C1024T2 C1524IF C1524T2 C2024IF C2024T2 C2028IF C2028T2 C2224IF C2224T2 C1024IFA C1024T2A C1524IFA C1524T2A C2024IFA C2024T2A C2028IFA C2028T2A C2224IFA C2224T2A	C1512IFAB C1512T2AB C1512IFB C1512T2B C1512IFC C1512T2C C2024IFB C2024T2B C2028IFB C2028T2B C2224IFB C2224T2B C2024IFB C2024T2B C2028IFB C2028T2B C2224IFB C2224T2B	C1024IFAB C1024T2AB C1524IFAB C1524T2AB C2024IFAB C2024T2AB C2028IFAB C2028T2AB C2224IFAB C2224T2AB C2024IFB C2024T2B C2028IFB C2028T2B C2224IFB C2224T2B	C1024IF C1024T2 C2024IF C2024T2 C1024IFA C1024T2A C1524IFA C1524T2A C2024IFA C2024T2A C2028IFA C2028T2A C2224IFA C2224T2A	C1512IF C1512T2 C1512IFA C1512T2A C1512IFB C1512T2B C1512IFC C1512T2C C2024IFB C2024T2B C2028IFB C2028T2B C2224IFB C2224T2B	C1012IFA C1012T2A C1512IFA C1512T2A C2024IFB C2024T2B C2028IFB C2028T2B C2224IFB C2224T2B	C1012IFA C1012T2A C1512IFA C1512T2A C2024IFB C2024T2B C2028IFB C2028T2B C2224IFB C2224T2B
MODELS NOT LISTED ARE OBSOLETE										
FAN BLADE		MOTOR			HI LIMIT				CLIP N FIT BOARD	
										
1210-2008-000 ALL MODELS	3900-2017-000	3900-2017-001	3900-2035-000	4520-11007-000	4520-11007-001	4520-2059-000			1249-2005-000	
	C1012IF C1012T2 C1512IF C1512T2 C1012IFA C1012T2A C1512IFA C1512T2A C1012FAA C1012T2AA C1512FAA C1512T2AA C1012IFAB C1012T2AB C1512IFAB C1512T2AB C1512IFB C1512T2B C1512IFC C1512T2C	C1024IF C1024T2 C1524IF C1524T2 C2024IF C2024T2 C1024IFA C1024T2A C1524IFA C1524T2A C2024IFA C2024T2A C1024IFAB C1024T2AB C1524IFAB C1524T2AB C2024IFAB C2024T2AB C2024IFB C2024T2B C2024IFC C2024T2C	C2028IF C2028T2 C2224IF C2224T2 C2028IFA C2028T2A C2224IFA C2224T2A C2028IFAB C2028T2AB C2224IFAB C2224T2AB C2028IFB C2028T2B C2224IFC C2224T2C	C1512IFC C1512T2C	C2024IFC C2024T2C C2028IFC C2224IFC C2224T2C	C1012IF C1012T2 C1512IF C1512T2 C1012IFA C1012T2A C1512IFA C1512T2A C1012FAA C1012T2AA C1512FAA C1512T2AA C1012IFAB C1012T2AB C1512IFAB C1512T2AB C1512IFB C1512T2B C1512IFC C1512T2C	C2024IF C2024T2 C1024IFA C1024T2A C1524IFA C1524T2A C2024IFA C2024T2A C1024IFAB C1024T2AB C1524IFAB C1524T2AB C2024IFAB C2024T2AB C2024IFB C2024T2B C2028IF C2224IF C1024T2 C1524IF C1524T2	C2224IFA C2224T2A C2028IFAB C2224IFAB C2028IFB C2224T2AB C2224IFB C2224T2B	C1512IFB C1512T2B C2024IFB C2028IFB C2224IFB C2224T2B C1512IFC C1512T2C C2024IFC C2024T2C C2224IFC C2224T2C	
THERMOSTAT		THERMAL FUSE								
410130001	5813-2090-000	4520-2030-000								
C1012T2 C1512T2 C1012T2A C1512T2A C1012T2AA C1512T2AA C1024T2 C1524T2 C2024T2 C1024T2A C1524T2A C2024T2A C2028T2 C2224T2 C2028T2A C2224T2A	C1012T2AB C1512T2AB C1512T2B C1512T2C C1024T2AB C1524T2AB C2024T2AB C2024T2B C2024T2C C2224T2AB C2224T2B C2224T2C	C1012FAA C1012T2AA C1512FAA C1512T2AA C1024T2AB C1524T2AB C2024T2AB C1512T2AB C1512T2A C1024T2AB C1524T2AB C2024T2AB C1524T2AB C2024T2AB C2024IFB C2024T2B C2028IFAB C2224IFAB C2224T2AB	C1512IFB C1512T2B C2024IFB C2024T2B C2028IFB C2224IFB C2224T2B C1512IFC C1512T2C C1512IFC C1512T2C C1512IFC C1512T2C C1512IFC C1512T2C C2024IFB C2024T2B C2028IFC C2224IFC C2224T2C							

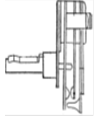
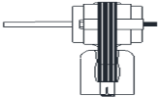
BVP					
MOTOR				LIMIT	
					
42528-052-01		42528-052-02		4520-2025-000	
VP1222	VP1222I	VP2022	VP2022I	VP1222C	VP2022IC
VP1222A	VP1222IB	VP2022A	VP2022IB	VP1222CNW	VP2022ICNW
VP1222AI	VP1222IBP	VP2022AI	VP2022IBP	VP1222IC	VP2422C
VP1222B	VP1222IC	VP2022B	VP2022IC	VP1222ICNW	VP2422CNW
VP1222C	VP1222ICNW	VP2022C	VP2022ICNW	VP2022C	VP2422IC
VP1222CNW		VP2022CNW		VP2022CNW	VP2422ICNW

A2500					
THERMOSTAT	ELEMENT	LIMIT	THERMAL FUSE	GRILLE	MOTOR
				PICTURE NOT AVAILABLE	
1230-8232	6101-8752	8541-8056	8671-8037	8683-8272	8767-8036
A2515T	A2530T	A2515T	A2515T	A2515T	A2515T
A2520T		A2520T	A2520T	A2520T	A2520T
A2530T		A2530T	A2530T	A2530T	A2530T
A2540T		A2540T	A2540T	A2540T	A2540T
A2548T		A2548T	A2548T	A2548T	A2548T

SCH SERIES						
ELEMENT						
						
302023801	302023802	302023803	302023804	302023805	302023806	302023807
SCH1012IF	SCH1512IF	SCH1527IF	SCH2020IF	SCH2024IF	SCH2027IF	SCH2012IF
SCH1012W	SCH1512W	SCH1527W	SCH2020W	SCH2024W	SCH2027W	SCH2012W
MOTOR			BLADE	FAN DELAY	LIMIT	
						
490062001	490062002	490062003	490062004	490061001	410074000	410169001
SCH1012IF	SCH2020IF	SCH2024IF	SCH1527IF	ALL MODELS	ALL MODELS	ALL MODELS
SCH1012W	SCH2020W	SCH2024W	SCH1527W			
SCH1512IF			SCH2027IF			
SCH1512W			SCH2027W			
SCH2012IF						
SCH2012W						

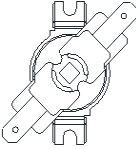
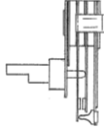
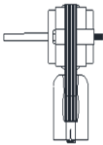
1235 & 2435 SERIES (OBS)					
SCREEN		KNOB	FACE PLATE	LIMIT	
					
1235-0037 1235 2435	8850-8046 1235P 2435P	3301-2047-000 ALL MODELS	4503-2094-000 ALL MODELS	8541-8054 ALL MODELS	
THERMOSTAT	MOTOR	FAN BLADE	ELEMENT	THERMAL FUSE	
					
1230-8194 ALL MODELS	1235-0007 ALL MODELS	1235-0008 ALL MODELS	6101-8741 ALL MODELS	8671-8036 2435 2435P	

B2400 SERIES (OBS)			
ELEMENT		LIMIT	THERMOSTAT
			
6101-8741 B2451	6101-8742 B2452	8541-8055 ALL MODELS	1230-8206 ALL MODELS
MOTOR		FAN BLADE	THERMAL FUSE
			
8767-8035 B2451	8767-8036 B2452	991-313 ALL MODELS	8671-8037 B2452

SR SERIES

ELEMENT



302023801 SR1012IFLTC SR1012IFLTP SR1012IFLTPB SR1012IFP SR1012LTC SR1012LTP SR1012LTPB SR1012P	302023802 SR1512CKJCP SR1512IFLTC SR1512IFLTP SR1512IFLTPB SR1512IFP SR1512IFPB SR1512LTC SR1512LTP SR1512LTPB SR1512P	302023803 SR1527IFLTC SR1527IFLTP SR1527IFLTPB SR1527IFP SR1527IFPB SR1527LTC SR1527LTP SR1527LTPB SR1527P	302023804 SR2020IFLTC SR2020IFLTP SR2020IFLTPB SR2020IFP SR2020LTC SR2020LTP SR2020LTPB SR2020P	302023805 SR2024IFLTC SR2024IFLTP SR2024IFLTPB SR2024IFP SR2024LTC SR2024LTP SR2024LTPB SR2024P	302023806 SR2027IFLTC SR2027IFLTP SR2027IFLTPB SR2027IFP SR2027LTC SR2027LTP SR2027LTPB SR2027P	302023807 SR2012IFLTC SR2012IFLTP SR2012IFLTPB SR2012IFP SR2012LTC SR2012LTP SR2012LTPB SR2012P
--	---	--	--	--	--	--

KNOB

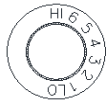

THERMOSTAT



FAN DELAY



SR1012C SR1012IFC SR1012IFP SR1012IFPB SR1012P SR1012PB SR1512C SR1512CKJCP SR1512IFC SR1512IFP SR1512IFPB SR1512P SR1512PB SR1527C SR1527IFC	3301-2020-008 SR1527IFP SR1527IFPB SR1527P SR1527PB SR2012C SR2012IFC SR2012IFP SR2012IFPB SR2012P SR2012PB SR2020C SR2020IFC SR2020IFP SR2020IFPB SR2020P	SR2020PB SR2024C SR2024IFC SR2024IFP SR2024IFPB SR2024P SR2024PB SR2027C SR2027IFC SR2027IFP SR2027IFPB SR2027P SR2027PB	SR1012C SR1012IFC SR1012IFP SR1012IFPB SR1012P SR1012PB SR1512C SR1512CKJCP SR1512IFC SR1512IFP SR1512IFPB SR1512P SR1512PB SR1527C SR1527IFC	5813-2027-000 SR1527IFP SR1527IFPB SR1527P SR1527PB SR2012C SR2012IFC SR2012IFP SR2012IFPB SR2012P SR2012PB SR2020C SR2020IFC SR2020IFP SR2020IFPB SR2020P	SR2020PB SR2024C SR2024IFC SR2024IFP SR2024IFPB SR2024P SR2024PB SR2027C SR2027IFC SR2027IFP SR2027IFPB SR2027P SR2027PB	410074000 ALL MODELS
---	--	--	---	--	--	--------------------------------

BLADE

















MOTOR









SR1012IFLTC SR1012IFLTP SR1012IFLTPB SR1012IFP SR1012LTC SR1012LTP SR1012LTPB SR1012P SR1512CKJCP SR1512IFLTC SR1512IFLTP SR1512IFLTPB SR1512IFP SR1512LTC SR1512LTP SR1512LTPB SR1512P SR1527IFLTC SR1527IFLTP SR1527IFLTPB SR1527IFP SR1527LTC	490061001 SR1527LTP SR1527LTPB SR1527P SR2012IFLTC SR2012IFLTP SR2012IFLTPB SR2012IFP SR2012LTC SR2012LTP SR2012LTPB SR2012P SR2012PB SR2020IFC SR2020IFP SR2020IFPB SR2020P	SR2024IFP SR2024LTC SR2024LTP SR2024LTPB SR2024P SR2027IFLTC SR2027IFLTP SR2027IFLTPB SR2027IFP SR2027LTC SR2027LTP SR2027LTPB SR2027P	SR1012IFLTC SR1012IFLTP SR1012IFLTPB SR1012IFP SR1012LTC SR1012LTP SR1012LTPB SR1012P SR1512CKJCP SR1512IFLTC SR1512IFLTP SR1512IFLTPB SR1512IFP	490062001 SR1512LTC SR1512LTP SR1512LTPB SR1512P SR2012IFLTC SR2012IFLTP SR2012IFLTPB SR2012IFP SR2012LTC SR2012LTP SR2012LTPB SR2012P	490062002 SR2020IFLTC SR2020IFLTP SR2020IFLTPB SR2020IFP SR2020LTC SR2020LTP SR2020LTPB SR2020P	490062003 SR2024IFLTC SR2024IFLTP SR2024IFLTPB SR2024IFP SR2024LTC SR2024LTP SR2024LTPB SR2024P	490062004 SR1527IFLTC SR1527IFLTP SR1527IFLTPB SR1527IFP SR1527LTC SR1527LTP SR1527LTPB SR1527P SR2027IFLTC SR2027IFLTP SR2027IFLTPB SR2027IFP SR2027LTC SR2027LTP SR2027LTPB SR2027P
---	---	--	--	---	--	--	--

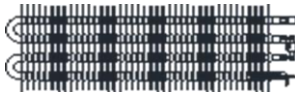

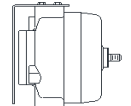







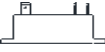

SRA SERIES WALL HEATER (OBS)

SRA SERIES WALL HEATER (OBS)								
GRILLE	PLASTIC COVER(2REQ)	KNOB	FAN BLADE	LIGHT				THERMAL FUSE
								
1402-2117-001 ALL MODELS	1402-2119-000 ALL MODELS	3301-2014-001 ALL MODELS	490061001 ALL MODELS	3510-2008-003 SRA1012B SRA1512B SRA1812B SRA1012DSB SRA1512DSB SRA1812DSB	3510-2008-002 SRA1527B SRA2020B SRA2024B SRA2027B SRA1527DSB SRA2020DSB SRA2024DSB SRA2027DSB	3510-2008-006 SRA1012DSC SRA1512DSC SRA1812DSC	3510-2008-007 SRA1527DSC SRA2020DSC SRA2024DSC SRA2027DSC	4520-2030-000 SRA1012DSC SRA1512DSC SRA1527DSC SRA1812DSC SRA2020DSC SRA2024DSC SRA2027DSC
THERMOSTAT		MANUAL LIMIT	DISCONNECT SW.	FAN DELAY			HI LIMIT	
								
5813-2001-000 SRA1012 SRA1012IF SRA1012A SRA1012B SRA1012DS SRA1012DSB SRA1012DSC SRA1512 SRA1512IF SRA1512A SRA1512B SRA1512DS SRA1512DSB SRA1512DSC SRA1527 SRA1527IF SRA1527A SRA1527B SRA1527DSB SRA1527DSC		5813-2022-000 SRA1812 SRA1812IF SRA1812A SRA1812B SRA1812DSB	4520-11016-000 SRA1012A SRA1512A SRA1527A SRA1812A SRA2020A SRA2024A SRA2027A SRA1012DS SRA1512DS SRA2024DS SRA2027DS SRA1012DSC SRA1512DSC SRA2024DSC SRA1812DSC SRA2027DSC	410170001 SRA1012DS SRA1012DSB SRA1012DSC SRA1512DS SRA1512DSB SRA1512DSC SRA1527DSC SRA1812DSB SRA1812DSC SRA2020DSB SRA2020DSC SRA2024DS SRA2024DSC SRA2027DS SRA2027DSB SRA2027DSC	410074000 SRA1012 SRA1012IF SRA1012B SRA1012DSB SRA1012DSC SRA1512 SRA1512IF SRA1512B SRA1512DSB SRA1512DSC SRA1527 SRA1527IF SRA1527B SRA1527DSB SRA1527DSC SRA1812 SRA1812IF SRA1812B SRA1812DSC	410143000 SRA1012 SRA1512 SRA1527 SRA1812 SRA2020 SRA2024 SRA2027 SRA1012IF SRA1512IF SRA1527IF SRA1812IF SRA2020IF SRA2024IF	SRA1012B SRA1512B SRA1527B SRA1812B SRA2020B SRA2024B SRA2027B SRA1012DSB SRA1512DSB SRA1527DSB SRA1812DSB SRA2020DSB SRA2024DSB SRA2027DSB	
MOTOR				ELEMENT				
								
490062001 SRA1012 SRA1512 SRA1812 SRA1012IF SRA1512IF SRA1812IF SRA1012A SRA1512A SRA1812A SRA1012B SRA1512B SRA1812B SRA1012DS SRA1512DS SRA1012DSB SRA1512DSB SRA1812DSB SRA1012DSC SRA1512DSC SRA1812DSC	490062002 SRA2020 SRA2020IF SRA2020A SRA2020B SRA2020DSB SRA2020DSC	490062003 SRA2024 SRA2024IF SRA2024A SRA2024B SRA2024DS SRA2024DSB SRA2024DSC	490062004 SRA1527 SRA2027 SRA1527IF SRA1527A SRA2027A SRA1527B SRA2027B SRA2027DS SRA1527DSB SRA2027DSB SRA1527DSC	302023801 SRA1012 SRA1012IF SRA1012A SRA1012B SRA1012DS SRA1012DSB SRA1012DSC 302023802 SRA1512 SRA1512IF SRA1512A SRA1512B SRA1512DS SRA1512DSB SRA1512DSC	302023803 SRA1527 SRA1527IF SRA1527A SRA1527B SRA1527DSB SRA1527DSC 302023808 SRA1812 SRA1812IF SRA1812A SRA1812B SRA1812DSB SRA1812DSC 302023806 SRA2027 SRA2027A SRA2027B SRA2027DS SRA2027DSB SRA2027DSC	302023804 SRA2020 SRA2020IF SRA2020A SRA2020B SRA2020DSB SRA2020DSC 302023805 SRA2024 SRA2024IF SRA2024A SRA2024B SRA2024DS SRA2024DSB SRA2024DSC		











FR SERIES

ELEMENT					THERMOSTAT		
							
302015806 FR1527 FR1527A FR1527AIF FR1527IF FR1527LT FR1527LTIF FR1527LTPB FR1527PB	302015801 FR2020 FR2020A FR2020AIF FR2020IF FR2020LT FR2020LTIF FR2020LTPB FR2020PB	302015802 FR2024 FR2024A FR2024AIF FR2024IF FR2024LT FR2024LTIF FR2024LTPB FR2024PB	302015803 FR2027 FR2027A FR2027AIF FR2027IF FR2027LT FR2027LTIF FR2027LTPB FR2027PB	302012806 FR3027 FR3027A FR3027AIF FR3027IF FR3027LT FR3027LTIF FR3027LTPB FR3027PB	FR1527 FR1527A FR1527AIF FR1527IF FR1527PB FR2020 FR2020A FR2020AIF FR2020IF FR2020PB FR2024 FR2024A FR2024AIF FR2024IF FR2024PB FR2027 FR2027A FR2027AIF FR2027IF FR2027PB	410168002 FR2027AIF FR2027IF FR2027PB FR3027 FR3027A FR3027AIF FR3027IF FR3027PB FR4020 FR4020A FR4020AIF FR4020IF FR4020PB FR4024 FR4024A FR4024AIF FR4024IF FR4024PB	FR4024PB FR4027 FR4027A FR4027AIF FR4027IF FR4027PB FR4824 FR4824A FR4824AIF FR4824IF FR4824PB FR4827 FR4827A FR4827AIF FR4827IF FR4827PB
302012807 FR4020 FR4020A FR4020AIF FR4020IF FR4020LT FR4020LTIF FR4020LTPB FR4020PB	302012808 FR4024 FR4024A FR4024AIF FR4024IF FR4024LT FR4024LTIF FR4024LTPB FR4024PB	302012809 FR4027 FR4027A FR4027AIF FR4027IF FR4027LT FR4027LTIF FR4027LTPB FR4027PB	302012810 FR4824 FR4824A FR4824AIF FR4824IF FR4824LT FR4824LTIF FR4824LTPB FR4824PB	302012811 FR4827 FR4827A FR4827AIF FR4827IF FR4827LT FR4827LTIF FR4827LTPB FR4827PB	FR2020IF FR2020PB FR2024 FR2024A FR2024AIF FR2024IF FR2024PB FR2027 FR2027A FR2027AIF FR2027IF	FR4020 FR4020A FR4020AIF FR4020IF FR4020PB FR4024 FR4024A FR4024AIF FR4024IF FR4024PB	FR4824AIF FR4824IF FR4824PB FR4827 FR4827A FR4827AIF FR4827IF FR4827PB
MOTOR					LIMIT	FAN DELAY	
							
490064001 FR2020 FR2020IF FR2020LT FR2020LTIF FR2020LTPB FR2020PB FR2024 FR2024A FR2024AIF FR2024IF FR2024LT FR2024LTIF FR2024LTPB FR2024PB FR4020 FR4020IF FR4020LT	FR4020LTIF FR4020LTPB FR4020PB FR4024 FR4024IF FR4024LT FR4024LTIF FR4024LTPB FR4024PB FR4824 FR4824AIF FR4824LTPB FR4824PB	490064003 FR1527 FR1527IF FR1527LT FR1527LTIF FR1527LTPB FR1527PB FR2027 FR2027IF FR2027LT FR2027LTIF FR2027LTPB FR2027PB FR3027 FR3027IF FR3027LT	FR3027LTIF FR3027LTPB FR3027PB FR4027 FR4027IF FR4027LT FR4027LTIF FR4027LTPB FR4027PB FR4827 FR4827IF FR4827LTPB FR4827PB	3900-2002-502 FR2020A FR2020AIF FR2024A FR2024AIF FR4020A FR4020AIF FR4024A FR4024AIF FR4824A FR4824AIF	3900-2002-503 FR1527A FR1527AIF FR2027A FR2027AIF FR3027A FR3027AIF FR4027A FR4027AIF FR4827A FR4827AIF	410169001 ALL MODELS BLADE  490030103 ALL MODELS	410074000 ALL MODELS

FRA SERIES WALL HEATER (OBSOLETE)

GRILLE		ELEMENT				RELAY			
									
1402-2241-001		302012806	302012809	302015801	302015806	1802-2075-800	5018-2017-004	5018-2017-000	
FRA2020B	FRA4024B	FRA3027	FRA4027	FRA2020	FRA1527	FRA40203	FRA40203	FRA40243	
FRA2024B	FRA40243B	FRA3027A	FRA4027A	FRA2020A	FRA1527A	FRA40203B	FRA4820	FRA48243	
FRA2027B	FRA4027B	FRA3027B	FRA4027B	FRA2020B	FRA1527B	1802-2075-801	FRA48203	FRA40243B	
FRA1512	FRA4820B	302012811		302015802		FRA4820	FRA48203B		
FRA1812	FRA48203B	FRA4020	FRA4827	FRA2024	FRA1512	FRA48203	FRA4820B		
FRA3027B	FRA4824B	FRA4020A	FRA4827A	FRA2024A	302012827		FRA48203B		
FRA4020B	FRA48243B	FRA4020B	FRA4827B	FRA2024B	FRA1512		FRA48203B		
FRA40203B	FRA4827B	302012810		FRA2024T2	FRA1812				
		FRA4020T2	FRA4824	FRA2024T2A			1802-2075-802		
		FRA4020T2A	FRA4824A	FRA2024T2A			FRA40243		
		302012808		302015803		1802-2075-803	FRA40243B		
		FRA4024	FRA4824B	FRA2027			FRA48243		
		FRA4024A	FRA4824T2	FRA2027A			FRA48243B		
		FRA4024B	FRA4824T2A	FRA2027B					
		FRA4024T2							
		FRA4024T2A							
MANUAL LIMIT		HI LIMIT		MOTOR		FAN DELAY			
									
4520-2027-000		410169001	3900-2002-501	3900-2002-500	3900-2002-518	4520-2024-000	410074000		
FRA40203	FRA2027B	FRA1527	FRA1527	FRA2020	FRA40203	FRA40203	FRA3027A	FRA4824	
FRA40243	FRA1512	FRA2020	FRA2027	FRA2024	FRA40243	FRA40243	FRA3027B	FRA4824A	
FRA4820	FRA1812	FRA2024	FRA3027	FRA4820	FRA4820	FRA4820	FRA1527B	FRA4824B	
FRA48203	FRA3027B	FRA2027	FRA4027	FRA4024	FRA48203	FRA48203	FRA2020	FRA4824T2	
FRA48243	FRA4020B	FRA3027	FRA4827	FRA4824	FRA48243	FRA48243	FRA2020A	FRA4824T2A	
FRA1527A	FRA40203B	FRA4020	3900-2010-000		FRA40203B	FRA48203B	FRA2020B	FRA4827	
FRA2020A	FRA4024B	FRA4024	FRA2020A	FRA2020T2	FRA40243B	FRA48203B	FRA2024	FRA4020T2A	
FRA2024A	FRA40243B	FRA4027	FRA2024A	FRA4024T2	FRA4820B	FRA48203B	FRA2024A	FRA4024	
FRA2027A	FRA4027B	FRA4824	FRA4020A	FRA4824T2	FRA48203B	FRA48203B	FRA2024B	FRA4024A	
FRA3027A	FRA4820B	FRA4827	FRA4024A	3900-2010-001	FRA48243B		FRA2024T2	FRA4024B	
FRA4020A	FRA48203B	FRA2024T2	FRA4824A	FRA1527	3900-2010-003		FRA2024T2A	FRA4024T2	
FRA4024A	FRA4824B	FRA4020T2	FRA2020B	FRA2027A	FRA1512	FRA1812	FRA2027A	FRA4024T2A	
FRA4027A	FRA48243B	FRA4024T2	FRA2024B	FRA3027A			FRA2027A	FRA4027	
FRA4824A	FRA4827B	FRA4824T2	FRA4020B	FRA4027A			FRA2027B	FRA4027A	
FRA4827A	FRA2024T2A	FRA4024B	FRA4024B	FRA4827A			FRA3027	FRA4027B	
FRA1527B	FRA4020T2A	FRA4824B	FRA4824B	FRA1527B					
FRA2020B	FRA4024T2A	FRA2024T2A	FRA2024T2A	FRA2027B					
FRA2024B	FRA4824T2A	FRA4020T2A	FRA4024T2A	FRA3027B					
		FRA4024T2A	FRA4827B	FRA4027B					
		FRA4824T2A	FRA4827B	FRA4827B					
THERMOSTAT		DISCONNECT SWITCH		FAN BLADE		PLASTIC COVER(2REQ)		KNOB	
									
410168002	5813-2059-000	5813-2027-000	5216-2019-000	410170001		490030103	1402-2120-000	3301-2014-001	
FRA1527	FRA1527B	FRA2024T2	FRA40203	FRA1527	FRA1527B	ALL MODELS	ALL MODELS	ALL MODELS	
FRA2020	FRA2020B	FRA4020T2	FRA40243	FRA2020	FRA2020B				
FRA2024	FRA2024B	FRA4024T2	FRA4820	FRA2024	FRA2024B				
FRA2027	FRA2027B	FRA4824T2	FRA48203	FRA2027	FRA2027B				
FRA3027	FRA1512	FRA2024T2A	FRA48243	FRA3027	FRA1512				
FRA4020	FRA1812	FRA4020T2A	FRA40203B	FRA4020	FRA1812				
FRA40203	FRA3027B	FRA4024T2A	FRA40243B	FRA4024	FRA3027B				
FRA4024	FRA4020B	FRA4824T2A	FRA4820B	FRA4027	FRA4020B				
FRA40243	FRA40203B	FRA4824T2A	FRA48203B	FRA4824	FRA4024B				
FRA4027	FRA4024B		FRA48243B	FRA4827	FRA4027B				
FRA4820	FRA40243B			FRA1527A	FRA4824B				
FRA48203	FRA4027B			FRA2020A	FRA4827B				
FRA4824	FRA4820B			FRA2024A	FRA2024T2				
FRA48243	FRA48203B			FRA2027A	FRA4020T2				
FRA4827	FRA4824B			FRA3027A	FRA4024T2				
FRA1527A	FRA48243B			FRA4020A	FRA4824T2				
FRA2020A	FRA4827B			FRA4024A	FRA2024T2A				
FRA2024A				FRA4027A	FRA4020T2A				
FRA2027A				FRA4824A	FRA4024T2A				
FRA3027A				FRA4827A	FRA4824T2A				
FRA4020A									
FRA4024A									
FRA4027A									
FRA4824A									
FRA4827A									









FRC SERIES (OBSOLETE)										
GRILLE				FAN DELAY				RELAY		
										
2501-2003-007				4520-2024-000				5018-2017-004		5018-2017-000
FRC40203	FRC2027AIF	FRC4827AIF	FRC2020C	FRC40203	FRC1527	FRC1527B	FRC1527A	FRC40203	FRC40243	
FRC40243	FRC3027A	FRC1527B	FRC2024C	FRC40243	FRC1527IF	FRC2027B	FRC1527AIF	FRC4820	FRC48243	
FRC4820	FRC3027AIF	FRC2020B	FRC2027C	FRC4820	FRC2027	FRC3027B	FRC3027A	FRC48203	FRC40243C	
FRC48203	FRC4020A	FRC2024B	FRC3027C	FRC48203	FRC2027IF	FRC4027B	FRC3027AIF	FRC40203C	FRC48243C	
FRC48243	FRC4020AIF	FRC2027B	FRC4020C	FRC48243	FRC3027	FRC4827B	FRC4027A	FRC4820C		
FRC1527A	FRC4024A	FRC3027B	FRC40203C	FRC40203C	FRC3027IF	FRC1527C	FRC4027AIF	FRC48203C		
FRC1527AIF	FRC4024AIF	FRC4020B	FRC4024C	FRC40243C	FRC4027	FRC2027C	FRC4827A			
FRC2020A	FRC4027A	FRC4024B	FRC40243C	FRC4820C	FRC4027IF	FRC3027C	FRC4827AIF			
FRC2020AIF	FRC4027AIF	FRC4027B	FRC4027C	FRC48203C	FRC4827	FRC4027C	FRC2020A			
FRC2024A	FRC4824A	FRC4824B	FRC4820C	FRC48243C	FRC4827IF	FRC4827C	FRC2020AIF			
FRC2024AIF	FRC4824AIF	FRC4827B	FRC48203C		FRC2020	FRC2020B	FRC2024A			
FRC2027A	FRC4827A	FRC1527C	FRC4824C		FRC2020IF	FRC2024B	FRC2024AIF			
			FRC48243C		FRC4020	FRC4020B	FRC4020A			
			FRC4827C		FRC4020IF	FRC4024B	FRC4020AIF			
					FRC2024	FRC4824B	FRC4024A			
					FRC2024IF	FRC2020C	FRC4024AIF			
					FRC4024	FRC2024C	FRC4824A			
					FRC4024IF	FRC4020C	FRC4824AIF			
					FRC4824	FRC4024C				
					FRC4824IF	FRC4824C				
ELEMENTS				MOTOR				FAN BLADE	THERMOSTAT	
										
302015806	302015801	302015802	302015803	490064003	3900-2010-001	3900-2002-501	3900-2002-518	490030103	410168002	
FRC1527	FRC2020	FRC2024	FRC2027	FRC1527	FRC1527B	FRC1527A	FRC40203	ALL MODELS	ALL MODELS	
FRC1527IF	FRC2020IF	FRC2024IF	FRC2027IF	FRC1527IF	FRC2027B	FRC1527AIF	FRC40243			
FRC1527A	FRC2020A	FRC2027A	FRC2027A	FRC2027	FRC3027B	FRC3027A	FRC4820			
FRC1527AIF	FRC2020AIF	FRC2024AIF	FRC2027AIF	FRC2027IF	FRC4027B	FRC3027AIF	FRC48203			
FRC1527B	FRC2020B	FRC2024B	FRC2027B	FRC3027	FRC4827B	FRC4027A	FRC48243			
FRC1527C	FRC2020C	FRC2024C	FRC2027C	FRC3027IF	FRC1527C	FRC4027AIF	FRC40203C			
				FRC4027	FRC2027C	FRC4827A	FRC40243C			
302012806	302012807	302012810	302012808	FRC4027IF	FRC3027C	FRC4827AIF	FRC4820C			
FRC3027	FRC4020	FRC4824	FRC4024	FRC4827	FRC4027C	3900-2002-500	FRC48203C			
FRC3027IF	FRC4020IF	FRC4824IF	FRC4024IF	FRC4827IF	FRC4827C	FRC2020A	FRC48243C			
FRC3027A	FRC4020A	FRC4824A	FRC4024A	490064001	3900-2010-000	FRC2020AIF	490064002			
FRC3027AIF	FRC4020AIF	FRC4824IFA	FRC4024AIF	FRC2020	FRC2020B	FRC2020AIF	FRC2024			
FRC3027B	FRC4020B	FRC4824B	FRC4024B	FRC2020IF	FRC2024B	FRC2024AIF	FRC2024IF			
FRC3027C	FRC4020C	FRC4824C	FRC4024C	FRC4020	FRC4020B	FRC4020A	FRC4024			
				FRC4020IF	FRC4024B	FRC4020AIF	FRC4024IF			
1802-2075-802	302012809	302012811	1802-2075-801	FRC4820	FRC4020B	FRC4024A	FRC4824			
FRC40243	FRC4027	FRC4827	FRC4820	FRC4020IF	FRC2024B	FRC4020AIF	FRC4824IF			
FRC40243C	FRC4027IF	FRC4827IF	FRC48203		FRC4824B	FRC4024A				
	FRC4027A	FRC4827A	FRC4820C		FRC2020C	FRC4024AIF				
1802-2075-800	FRC4027AIF	FRC4827IFA	FRC48203C		FRC2024C	FRC4824A				
FRC40203	FRC4027B	FRC4827B	1802-2075-803		FRC4020C	FRC4824AIF				
FRC40203C	FRC4027C	FRC4827C	FRC48243		FRC4024C					
			FRC48243C		FRC4824C					
DISCONNECT SWITCH				MANUAL LIMIT				HI LIMIT		
										
5216-2019-000	410170001			4520-2027-000				410169001		
FRC40203	FRC1527	FRC2020B	FRC2024A	FRC2027	FRC1527B	FRC2020C	FRC1527	FRC4027	FRC2027	
FRC40243	FRC1527IF	FRC2020C	FRC2024AIF	FRC2027IF	FRC2027B	FRC2024C	FRC1527IF	FRC4027IF	FRC2027IF	
FRC4820	FRC1527A	FRC4020	FRC2024B	FRC2027A	FRC3027B	FRC4020C	FRC1527A	FRC4027A	FRC2027A	
FRC48203	FRC1527AIF	FRC4020IF	FRC2024C	FRC2027AIF	FRC4027B	FRC4024C	FRC1527AIF	FRC4027AIF	FRC2027AIF	
FRC48243	FRC1527B	FRC4020A	FRC4824	FRC2027B	FRC4827B	FRC4824C	FRC3027	FRC2024	FRC4024	
FRC40203C	FRC1527C	FRC4020AIF	FRC4824IF	FRC2027C	FRC2020B	FRC40203	FRC3027IF	FRC2024IF	FRC4024IF	
FRC40243C	FRC3027	FRC4020B	FRC4824A	FRC4024	FRC2024B	FRC40243	FRC3027A	FRC2024A	FRC4024A	
FRC4820C	FRC3027IF	FRC4020C	FRC4824IFA	FRC4024IF	FRC4020B	FRC4820	FRC3027AIF	FRC2024AIF	FRC4024AIF	
FRC48203C	FRC3027A	FRC4027	FRC4824B	FRC4024A	FRC4024B	FRC48203	FRC2020	FRC4824		
FRC48243C	FRC3027AIF	FRC4027IF	FRC4824C	FRC4024AIF	FRC4824B	FRC48243	FRC2020IF	FRC4824IF		
	FRC3027B	FRC4027A	FRC4827	FRC4024B	FRC1527C	FRC40203C	FRC2020A	FRC4824A		
	FRC3027C	FRC4027AIF	FRC4827IF	FRC4024C	FRC2027C	FRC40243C	FRC2020AIF	FRC4824IFA		
	FRC2020	FRC4027B	FRC4827A		FRC3027C	FRC4820C	FRC4020	FRC4824		
	FRC2020IF	FRC4027C	FRC4827IFA		FRC4027C	FRC48203C	FRC4020IF	FRC4827IF		
	FRC2020A	FRC2024	FRC4827B		FRC4827C	FRC48243C	FRC4020A	FRC4827A		
	FRC2020AIF	FRC2024IF	FRC4827C				FRC4020AIF	FRC4827IFA		



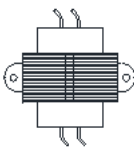

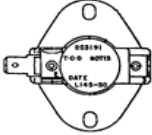
CUH OBSOLETE

DISCRIPTION	PART NUMBERS			
	CUH3	CUH4	CUH6	CUH7
FAN MOTOR: SINGLE SHAFT DOUBLE SHAFT	3900-2032-000* -	- 3900-2033-000*	3900-2032-000 3900-2033-000	- 3900-2033-000**
POWER TRANSFORMER: 277V 480V	490015009 490015010	490015009 490015010	490015007 490015008	490015007 490015008
* ONE REQUIRED ** TWO REQUIRED				
CIRCUIT BREAKERS				
REPLACEMENT CIRCUIT BREAKERS, FOR HEATERS SO EQUIPPED, ARE STANDARD, OFF-THE-SHELF ITEMS INVENTORIED BY MOST ELECTRICAL DISTRIBUTORS.				







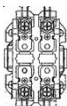
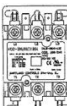
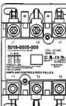
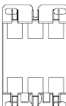
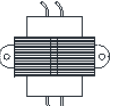

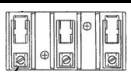

VUH & VUH-A

BLADE	RELAY		TRANSFORMER	
				
490020000	5018-0005-006		5018-0006-002	
H2520	H1020A	H1048A	H2520	490015018
H2524	H1024A	H1555A	H2524	H1034A
H2548	H1027A	H1560A	H2548	H1534A
H2555	H1034A	H2020	H2555	490015019
H2560	H1048A	H2024	H3020	H2034
H3020	H1055A	H2027	H3024	490015021
H3024	H1060A	H2034	H3048	H1060A
H3048	H1520A	H2048	H3055	H1560A
H3055	H1524A	H2055	H4020	490015005
H3060	H1527A	H2060	H4024	H2027
H4020	H1534A		H4048	490015015
H4024			H4055	H5048
H4048			H5020	H5055
H4055			H5024	
H4060			H5060	
LIMIT	FAN DELAY	CAPACITOR		
				
410029000 ALL MODELS	410126000 ALL MODELS	1432-0002-003 ALL MODELS		





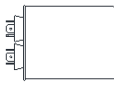

HUHAA SERIES

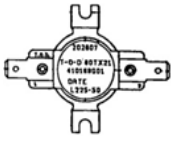
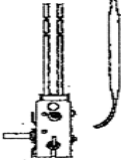
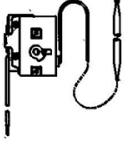
ELEMENT				MOTOR					
QUANTITY OF ELEMENTS 3 THRU 10KW (3) 15 THRU 30KW (6) 40 & 50KW (9)									
1802-0087-024 HUHAA320	1802-0087-031 HUHAA720 HUHAA1024	1802-0087-037 HUHAA1520 HUHAA2024	1802-0087-018 HUHAA3024	3900-2002-506 HUHAA320 HUHAA324 HUHAA520 HUHAA524	3900-0347-005 HUHAA748 HUHAA1048	3900-0363-500 HUHAA2548 HUHAA3048			
1802-0087-000 HUHAA324	1802-0087-006 HUHAA724	1802-0087-012 HUHAA1524	1802-0087-019 HUHAA3048 HUHAA3048A	3900-0361-500 HUHAA1520 HUHAA1524	3900-2065-000 HUHAA2548A HUHAA3048A	3900-0350-002 HUHAA5020			
1802-0087-001 HUHAA327	1802-0087-007 HUHAA727	1802-0087-008 HUHAA1548	1802-0087-020 HUHAA4024	3900-2002-507 HUHAA327 HUHAA527	3900-0361-501 HUHAA1548	3900-0350-000 HUHAA4024 HUHAA5024			
1802-0087-002 HUHAA348	1802-0087-008 HUHAA2020	1802-0087-026 HUHAA4048	1802-0087-021 HUHAA4048	3900-2005-000 HUHAA348 HUHAA548	3900-0362-002 HUHAA2020	3900-0350-001 HUHAA4048 HUHAA5048			
1802-0087-034 HUHAA520	1802-0087-036 HUHAA1020	1802-0087-016 HUHAA2524	1802-0087-030 HUHAA5020	3900-2014-004 HUHAA720 HUHAA724	3900-0362-000 HUHAA2024	3900-0362-001 HUHAA2048			
1802-0087-035 HUHAA524	1802-0087-010 HUHAA1027	1802-0087-017 HUHAA2548 HUHAA2548A	1802-0087-022 HUHAA5024	HUHAA727 HUHAA1020 HUHAA1024 HUHAA1027	3900-0364-000 HUHAA2524 HUHAA3020 HUHAA3024				
1802-0087-004 HUHAA527 HUHAA548	1802-0087-011 HUHAA1048 HUHAA2048	1802-0087-028 HUHAA3020	1802-0087-023 HUHAA5048						
FAN BLADE				PROTECTOR LIMIT		FAN DELAY			
									
1210-2000-000 HUHAA320 HUHAA324 HUHAA327 HUHAA348 HUHAA520 HUHAA524 HUHAA527 HUHAA548	1210-0090-000 HUHAA720 HUHAA724 HUHAA727 HUHAA748 HUHAA1020 HUHAA1024 HUHAA1027 HUHAA1048	1210-0098-000 HUHAA2524 HUHAA2548 HUHAA2548A HUHAA3020 HUHAA3024 HUHAA3048 HUHAA3048A	4520-0011-000 HUHAA320 HUHAA324 HUHAA327 HUHAA348 HUHAA520 HUHAA524 HUHAA527 HUHAA548	4520-0011-001 HUHAA720 HUHAA724 HUHAA727 HUHAA748 HUHAA1020 HUHAA1024 HUHAA1027 HUHAA1048 HUHAA1520 HUHAA1524 HUHAA1548 HUHAA2020 HUHAA2024 HUHAA2048	4520-0011-002 HUHAA2524 HUHAA2548 HUHAA2548A HUHAA3020 HUHAA3024 HUHAA3048 HUHAA3048A HUHAA4024 HUHAA4048 HUHAA5020 HUHAA5024 HUHAA5048	4520-0010-000 ALL MODELS			
	1210-0090-001 HUHAA1520 HUHAA1524 HUHAA1548	1210-11004-000 HUHAA4024 HUHAA4048 HUHAA5020 HUHAA5024 HUHAA5048							
	1210-0096-000 HUHAA2020 HUHAA2024 HUHAA2048								
RELAY				POWER TR					
									
5018-0003-000 HUHAA720 HUHAA724 HUHAA727 HUHAA1024 HUHAA1027	5018-0004-100 HUHAA348 HUHAA548 HUHAA748 HUHAA1020 HUHAA1048 HUHAA1548 HUHAA2048 HUHAA4048 HUHAA5048	5018-0005-004 HUHAA1520 HUHAA1524 HUHAA2020 HUHAA2524 HUHAA2548 HUHAA3024 HUHAA3048 HUHAA3048A HUHAA4024 HUHAA4048 HUHAA5024	5018-0006-000 HUHAA2024 HUHAA3020 HUHAA5020 HUHAA5048	5814-0003-000 HUHAA720 HUHAA724 HUHAA1020 HUHAA1024 HUHAA1520 HUHAA1524 HUHAA2020 HUHAA2024 HUHAA2524 HUHAA3020 HUHAA3024	5814-0003-002 HUHAA720 HUHAA724 HUHAA1048 HUHAA1548 HUHAA2048 HUHAA2548 HUHAA2548A HUHAA3048 HUHAA3048A HUHAA4048 HUHAA5048	490026007 HUHAA4024 HUHAA5020 HUHAA5024			
				5814-0003-001 HUHAA727 HUHAA1027					

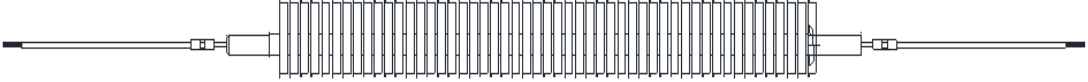
HUHAA CONTINUED

CONTROL BOARD			POWER BLOCK		FUSE BLOCK	FUSE	
							
5823-0001-000 HUHAA320 HUHAA324 HUHAA327 HUHAA520 HUHAA524 HUHAA527	5823-0002-000 HUHAA348 HUHAA548 HUHAA2024 HUHAA724 HUHAA727 HUHAA748 HUHAA1020 HUHAA1024 HUHAA1027 HUHAA1048 HUHAA1520 HUHAA1524 HUHAA1548		5823-0004-000 HUHAA320 HUHAA324 HUHAA327 HUHAA348 HUHAA520 HUHAA524 HUHAA527 HUHAA548 HUHAA720 HUHAA724 HUHAA727 HUHAA748 HUHAA1020 HUHAA1024 HUHAA1027 HUHAA1048 HUHAA1548 HUHAA2048		5823-0004-001 HUHAA1524 HUHAA2548 HUHAA2548A HUHAA3048 HUHAA3048A 5823-0004-002 HUHAA2020 HUHAA2024 HUHAA2524 HUHAA4048 HUHAA5048 5823-0004-003 HUHAA1520 HUHAA3024 5823-0005-000 HUHAA3020 HUHAA4024 HUHAA5020 HUHAA5024	2025-0002-000 HUHAA1520 HUHAA2020 480030004 HUHAA2524 HUHAA3020 HUHAA3024 HUHAA4024 HUHAA5020 HUHAA5024 2025-0001-000 HUHAA5048 2025-7004-000 HUHAA5048	2019-0007-010 HUHAA1520 2019-0007-008 HUHAA2020 2019-7008-077 HUHAA2524 2019-7008-080 HUHAA3020 HUHAA5020 2019-7008-079 HUHAA3024 HUHAA5024 2019-7008-078 HUHAA4024 2019-7002-008 HUHAA5048 2019-7002-012 HUHAA5048
LOUVERS QUANTITY 3&5KW (5) 7 THRU 20KW (6) 25 THRU 50KW (9) 			LOUVER SPRING 	HI/LOW SW. 	CAPACITOR 		
3503-2004-106 HUHAA320 HUHAA324 HUHAA327 HUHAA348 HUHAA520 HUHAA524 HUHAA527 HUHAA548	3503-2004-101 HUHAA720 HUHAA724 HUHAA727 HUHAA748 HUHAA1020 HUHAA1024 HUHAA1027 HUHAA1048 HUHAA1520 HUHAA1524 HUHAA1548 HUHAA2020 HUHAA2024 HUHAA2048	3503-2004-108 HUHAA2524 HUHAA2548 HUHAA2548A HUHAA3020 HUHAA3024 HUHAA3048 HUHAA3048A HUHAA4024 HUHAA4048 HUHAA5020 HUHAA5024 HUHAA5048	5208-7005-001 ALL MODELS	5216-2053-000 HUHAA2524 HUHAA2548 HUHAA2548A HUHAA3020 HUHAA3024 HUHAA3048 HUHAA3048A HUHAA4024 HUHAA4048 HUHAA5020 HUHAA5024 HUHAA5048	1432-0002-003 HUHAA2020 HUHAA2024 HUHAA2048 HUHAA2524 HUHAA2548 1432-0002-001 HUHAA3020 HUHAA2548A HUHAA3048A 1432-0002-004 HUHAA4024 HUHAA4048 HUHAA5020 HUHAA5024 HUHAA5048		

CC & DCC		
SPOT LIMIT	THERMOSTAT 1-POLE	THERMOSTAT 2-POLE
		
410027000 ALL MODELS	410112000 ALL MODELS	410113000 ALL MODELS

DB SERIES				
				
DISCRIPTION	PART NUMBERS			
	120V	208V	240V	277V
*ELEMENT (100 WATTS/FT)				
38"	1802-2016-014	1802-2016-006	1802-2016-007	1802-2016-015
50"	1802-2016-016	1802-2016-017	1802-2016-018	1802-2016-019
62"	1802-2016-026	1802-2016-027	1802-2016-028	1802-2016-029
*ELEMENT (188 WATTS/FT)				
38"	1802-2016-012	1802-2016-010	1802-2016-011	1802-2016-013
50"	1802-2016-020	1802-2016-024	1802-2016-025	1802-2016-021
62"	1802-2016-030	1802-2016-034	1802-2016-035	1802-2016-031
				
LINEAR LIMIT		TERMINAL BOX COVER	ELEMENT HANGER CLIP	
38"	410122003	310527001	402020000	
50"	410122004			
62"	410122005			
				
FRONT COVER		TOP GRILLE ASSEMBLY		
38"	310124008	38"	310817903	
50"	310124009	50"	310817904	
62"	310124010	62"	31087905	

RH SERIES				
KEY NUMBER	DESCRIPTION	PART NUMBER		
		RH__26	RH__35	RH__48
1	REFLECTOR: 60/90 SYM	-	-	-
	30 DEGREES SYM	-	-	-
	60/90 ASYM	-	-	-
	30 DEGREES ASYM	-	-	-
2	INSULATOR	-	-	-
3	TERMINAL BLOCK (4 REQ)	1224-0049-000	1224-0049-000	1224-0049-000
4	ELEMENT TERM. BUSH. (4 REQ)	1213-0070-000	1213-0070-000	1213-0070-000
ELEMENTS				
-	RH16-91S-208	2QL16208		
	RH16-91S-240	2QL16240		
	RH16-91S-277	2QL16277		

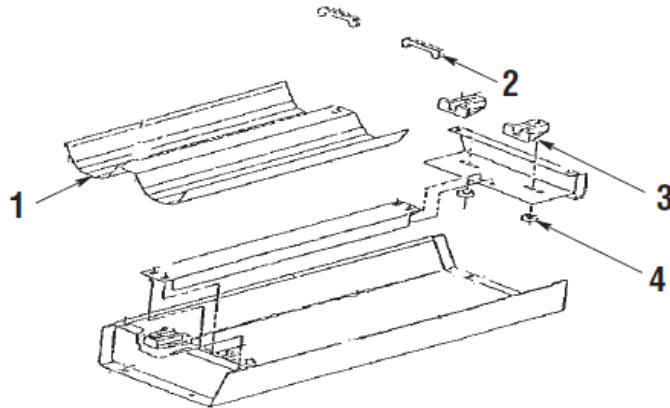

OBSOLETE INDUSTRIAL AIR CIRCULATORS			
BLADE			SWITCH
LCCLIN2419BL LCHHD24	1210-2035-000 LCHXN24	1210-2014-000 LCHIN24	5216-2059-000 LCHHD24
LCCLIN30BL LCHHD30	LCCLIN3016BL LCHXN30	1210-2026-000 LCHIN30	LCHHD30 LCHIN24 LCHIN30