

ASL3 & ASL5 SERIES

Architectural Sill-Height Convector

CONVECTORS



Ideal Spaces:

Living Rooms
Bedrooms
Offices
Hallways & Lobbies
Condos
Conference Rooms;
Retail Spaces
Floor-to-Ceiling Curtain Walls

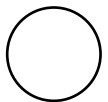

White

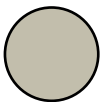

Beige

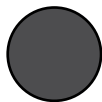

Charcoal Grey



Bronze



Black

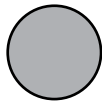

Aluminum



Custom and/or Anodized
Colors also Available

- › ASL3 Series is approved for residential applications
- › Patented “Stair-Step” SHA heating element design accommodates a multitude of applications and heating needs (see diagram on next page)
- › Unique two-piece extruded aluminum “Snap-Lock” closure design secures the one-piece top and front grilles to the one-piece back and bottom providing a rapid, secure fit along the length of the unit
- › Front/bottom inlet air grille utilizes slots which create an attractive installation where inlet grille is visible
- › Blend into any décor with custom paint and anodizing upon request
- › Units can be mounted on floor, wall, or pedestals
- › Customize space with wall-to-wall installation, or as discrete units in standard lengths of 28 in. to 12 ft.
- › Units are available in a wide range of heating capacities per foot length (see specifications)
- › Architectural-style end sections give a finished look when used as a stand-alone or where a wall-to-wall run is not desired
- › Inside and outside corners can be ordered factory-cut and mitered to fit difficult or unusual spaces
- › Right -or left-hand entry and built-in wireway (equivalent to ¾ in. conduit) with factory-installed wiring
- › Full line of trim accessories, including matching blank sections, end caps, filler sections, inside and outside corners, diagonal end sections, and splice plates
- › Optional built-in controls include: line-voltage thermostat; two-stage thermostat; on/off switch; transformer relay; power relay and pneumatic/switch
- › Easy connection of supply wiring from bottom, rear or end, as well as multiple wiring of adjacent heaters from one entry point
- › Thermal limit switch with linear type (full length) sensing bulb provides constant protection against overheating. Switch will automatically reset when normal operating temperatures are restored
- › Discharge air openings in top grille are punched slots which are pencil-proof for safety



ASL3 & ASL5 SERIES

Architectural Sill-Height Convectors

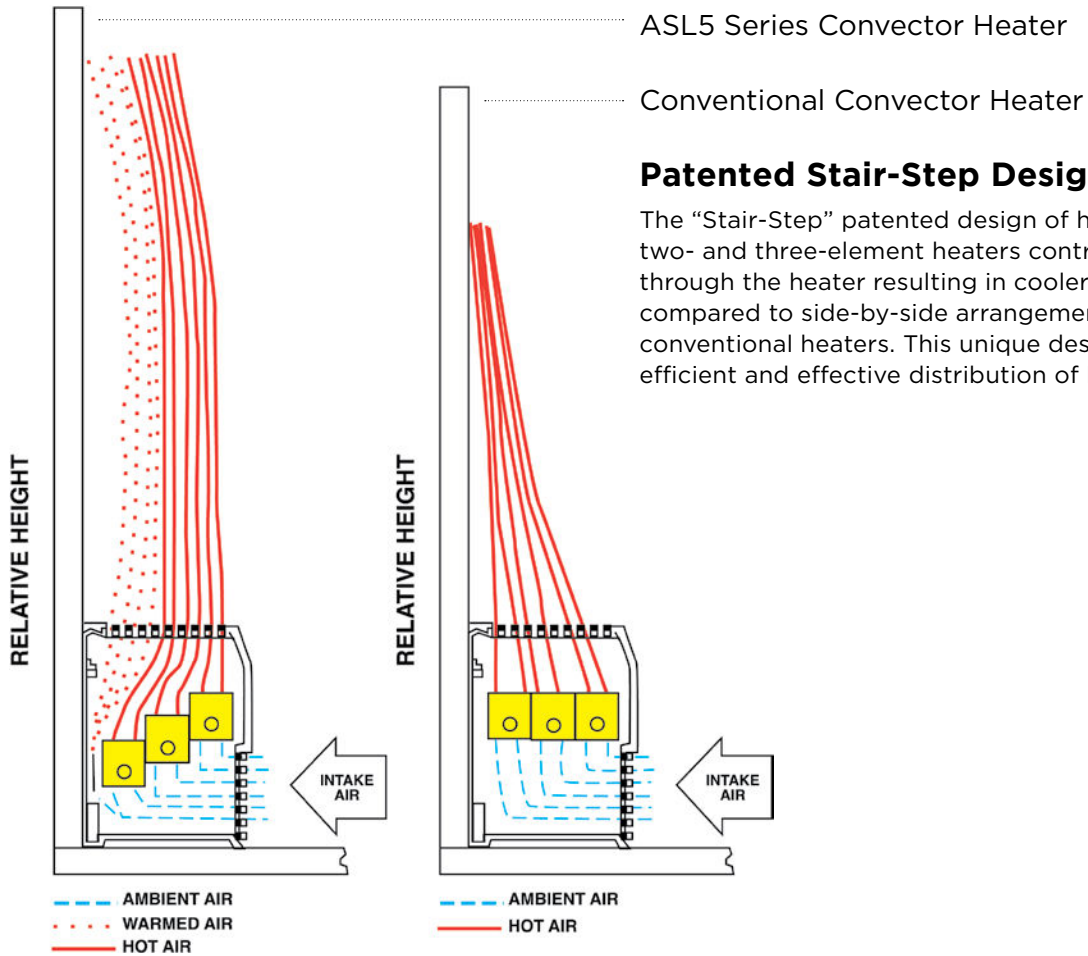

Dimensions and Clearances:

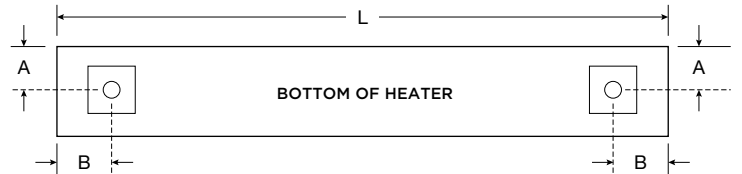
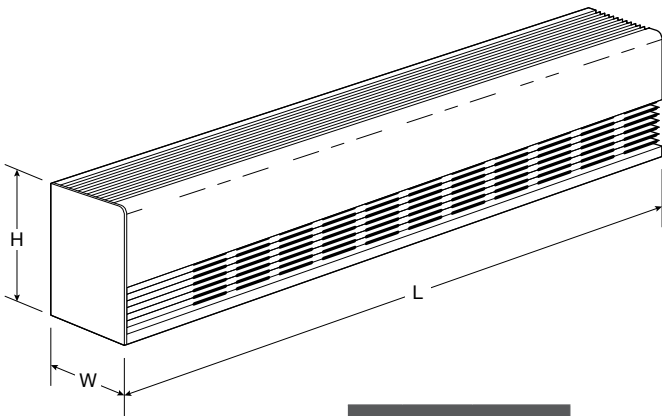

| Dimensions | | | |
|------------|----|--------|---------|
| Cat. No. | H | W | L |
| ASL3 | 6" | 3 5/8" | 28"-12' |
| ASL5 | 7" | 5 5/8" | 28"-12' |

| Standard Pedestal Placement | | |
|-----------------------------|----------|--------|
| Cat. No. | A | B |
| ASL3 | 2" | 2 1/4" |
| ASL5 | 2 13/16" | 2 1/4" |

ASL3 & ASL5 SERIES

Architectural Sill-Height Convectors

ASL3 & ASL5 (1 Element) Lengths

| | | | | | | | | | |
|------------------------|-------|--------|--------|--------|--------|--------|--------|--------|--------|
| <i>Length</i> | 28" | 3' | 4' | 5' | 6' | 7' | 8' | 9' | 10' |
| <i>Shipping Weight</i> | 8 lbs | 10 lbs | 13 lbs | 17 lbs | 20 lbs | 24 lbs | 27 lbs | 30 lbs | 33 lbs |

NOTE: Cabinet available up to 12 ft. length. Custom length cabinets are priced with heater and blank to the next larger size. Backs are provided standard with no finish. For finished backs, add 10% to list price. Knockouts on back omitted by request only. All models are NON-STOCK made-to-order. When ordering, specify quantity, catalog number, voltage, wattage, optional controls, and color. Consult sales representative for lead times.

Watts per Ft.*

| | | |
|-----|-----|-----|
| 100 | 125 | 150 |
| 188 | 250 | |

Voltages*

| | | | |
|-----|-----|-----|-----|
| 120 | 208 | 240 | 277 |
| 480 | 347 | 600 | |

ASL5 (Multiple Elements) Lengths

| | | | | | | | | | |
|------------------------|--------|----------|--------|----------|--------|--------|--------|--------|--------|
| <i>Length</i> | 28" | 3' | 4' | 5' | 6' | 7' | 8' | 9' | 10' |
| <i>Shipping Weight</i> | 12 lbs | 15.5 lbs | 20 lbs | 25.5 lbs | 30 lbs | 35 lbs | 40 lbs | 45 lbs | 50 lbs |

NOTE: Cabinet available up to 12 ft. length. Custom length cabinets are priced with heater and blank to the next larger size. Backs are provided standard with no finish. For finished backs, add 10% to list price. Knockouts on back omitted by request only. All models are NON-STOCK made-to-order. When ordering, specify quantity, catalog number, voltage, wattage, optional controls, and color. Consult sales representative for lead times.

Watts per Ft. — 2 Elements*

| | |
|-----|-----|
| 375 | 500 |
|-----|-----|

Voltages — Single Phase*

| | | | | |
|-----|-----|-----|-----|-----|
| 208 | 240 | 277 | 347 | 600 |
|-----|-----|-----|-----|-----|

Watts per Ft. — 3 Elements*

| | |
|-----|-----|
| 600 | 750 |
|-----|-----|

Voltages — Three Phase*

| | | |
|-----|-----|-----|
| 208 | 240 | 600 |
|-----|-----|-----|

*Specs vary by length. Reference the submittal sheet or additional detail

Optional Built-In Controls:

| SUFFIX* | OPTIONAL BUILT-IN CONTROL | RATINGS & DESCRIPTION |
|---------|---------------------------|--|
| T | Single-Pole Thermostat | Rated 25 amps @ 120-240 VAC and 22 amps @ 277 VAC. Pilot duty rating of 125 VA (all voltages). 60-120°F temperature range; adjustable through outlet grille-tamper-resistant. (See Note B) Not available on three-phase heaters. |
| 2T | Double-Pole Thermostat | Rated 25 amps @ 120-240 VAC and 22 amps @ 277 VAC. Pilot duty rating of 125 VA (all voltages). 60-120°F temperature range; adjustable through outlet grille-tamper-resistant. (See Note B for amperage restrictions.) |
| DS | Power On/Off Switch | Double-pole, rated 20 amp @ 120-277 VAC. (See Note A) For three-phase heaters and single-phase heaters over 20 amps specify two. |
| TR | Transformer Relay | Single-pole, low voltage relay with built-in transformer (24 VAC control), rated 22 amps @ 120-240 VAC and 22 amps @ 277 VAC. (See note E) 17 amps @ 347V. Not available on three-phase heaters. |
| PR | Power Relay | Single-pole thermal time delay relay, rated 25 amps @ 120-600 VAC. (See Notes E & F). Specify control voltage. |
| 2ST | 2-Stage Thermostat | Rated 24 amps @ 120-240 VAC and 22 amps @ 277 VAC. Pilot duty rating of 125 VA (all voltages). 60-120°F temperature range, adjustable through outlet grille-tamper-resistant. Available on 2- or 3-element, single-phase heaters only. |
| PDT | Single-Pole Thermostat | Same as -T except Pilot Duty. (See Note C) |
| 2TPD | Double-Pole Thermostat | Same as -2T except Pilot Duty. (See Note C & D) |
| M | Outlet Mesh | Price per foot |

NOTE: *Addition To Basic Catalog No. (See Note D)

A. For single-phase loads over 20A and all three-phase loads, specify (2) power on/off switches. **B.** This control option is not available on single-phase heaters over 25 amps (22 amps on 277 VAC). In combination with the power on/off switch option use the 2ST thermostat option on heaters over 20 amps. **C.** A second transformer relay can be sequenced off the first transformer relay in the same heater. Up to 30 power relays in different heaters can be controlled by (1) single-stage pilot duty thermostat. **D.** Up to 30 power relays in different heater can be controlled by each stage of a two-stage pilot duty thermostat. **E.** Two relays are required on single-phase heaters over 20 amps with a power on/off switch, over 25 amps without a power on/off and on all three-phase heaters. Two relays are available for two-stage on two- or three-element heaters only. **F.** Three power relays are available for three-stage on three-element heaters only.

Reference Marley Catalog and Submittals for additional control option details.

ASL3 & ASL5 SERIES

Architectural Sill-Height Convactor

Blank Sections & Accessories — ASL3 Series:

| CATALOG NO. | DIMENSIONS (W x H x L) | INLET | SHIP WT. |
|-------------|------------------------|--------|----------|
| ASL3BS1F | 3 3/8" x 6" x 1' | Front | 4 lbs |
| ASL3BS1B | | Bottom | |
| ASL3BS2F | 3 3/8" x 6" x 28" | Front | 7 lbs |
| ASL3BS2B | | Bottom | |
| ASL3BS3F | 3 3/8" x 6" x 3' | Front | 9 lbs |
| ASL3BS3B | | Bottom | |
| ASL3BS4F | 3 3/8" x 6" x 4' | Front | 12 lbs |
| ASL3BS4B | | Bottom | |
| ASL3BS5F | 3 3/8" x 6" x 5' | Front | 16 lbs |
| ASL3BS5B | | Bottom | |
| ASL3BS6F | 3 3/8" x 6" x 6' | Front | 19 lbs |
| ASL3BS6B | | Bottom | |
| ASL3BS7F | 3 3/8" x 6" x 7' | Front | 22 lbs |
| ASL3BS7B | | Bottom | |
| ASL3BS8F | 3 3/8" x 6" x 8' | Front | 24 lbs |
| ASL3BS8B | | Bottom | |
| ASL3BS9F | 3 3/8" x 6" x 9' | Front | 27 lbs |
| ASL3BS9B | | Bottom | |
| ASL3BS10F | 3 3/8" x 6" x 10' | Front | 30 lbs |
| ASL3BS10B | | Bottom | |

NOTE: Blank section grilles are not punched unless requested.

| CATALOG NO. | DESCRIPTION | ADDITIONAL SPACE REQUIRED | SHIP WT. |
|-------------|--------------------------------------|---------------------------|----------|
| ASL3ECLS | End Cap w/Screws - Left | | |
| ASL3ECRS | End Cap w/Screws - Right | | |
| ASL31CF | Inside Corner-Front In | 8 1/2" | 5 lbs |
| ASL31CB | Inside Corner-Bottom In | 8 1/2" | 5 lbs |
| ASL3OCF | Outside Corner-Front In | 5" | 4 lbs |
| ASL3OCB | Outside Corner-Bottom In | 5" | 4 lbs |
| ASL3135ICF | 135° Inside Corner-Front In | 8 1/2" | 5 lbs |
| ASL3135ICB | 135° Inside Corner-Bottom In | 8 1/2" | 5 lbs |
| ASL3135OCF | 135° Outside Corner-Front In | 5" | 4 lbs |
| ASL3135OCB | 135° Outside Corner-Bottom In | 5" | 4 lbs |
| ASL3DESB | Dec. End Section-Bottom In, Left | 9 3/4" | 5 lbs |
| ASL3DESB | Dec. End Section-Bottom In, Right | | 5 lbs |
| ASL3DESFL | Dec. End Section-Front In, Left | | 4 lbs |
| ASL3DESFR | Dec. End Section-Front In, Right | | 4 lbs |
| ASL3SP | Splice Plate | 0-1/4" | 1 lbs |
| ASL3FL3 | Filler Section 3 in. | 0-3" | 1 lbs |
| ASL3FL6 | Filler Section 6 in. | 3-6" | 1 lbs |
| ASL3FL9 | Filler Section 9 in. | 6-9" | 1 lbs |
| ASL3FL12 | Filler Section 12 in. | 9-12" | 1 lbs |
| ASL3-FL18 | Filler Section 18 in. | 15-18" | 1.5 lbs |
| ASL3DRF | Receptacle Section-Front In | 4 1/2" | 1.5 lbs |
| ASL3DRB | Receptacle Section-Bottom In | | |
| ASL3PEF | Pneu/Ele Sw-Fnt. In | 4 1/2" | 2 lbs |
| ASL3PEB | Pneu/Ele Sw-Bot. In | | |
| PK3S* | Standard Pedestal 2 3/8 in. (H) | - | 2 lbs |
| PK3A* | Architectural Pedestal 2 3/8 in. (H) | - | 2 lbs |
| SO1A | Stand-Off Bracket | - | 1 lbs |

*One pedestal. Two required on units up to 10 ft, three required on units over 10ft.

**Add suffix -P for painted followed by the color code (i.e. W for White, B for Black, etc.), -C for clear anodized, -B for bronze anodized (excludes PK3S—Black only).

*** All Stand-off Brackets come standard as Beige.

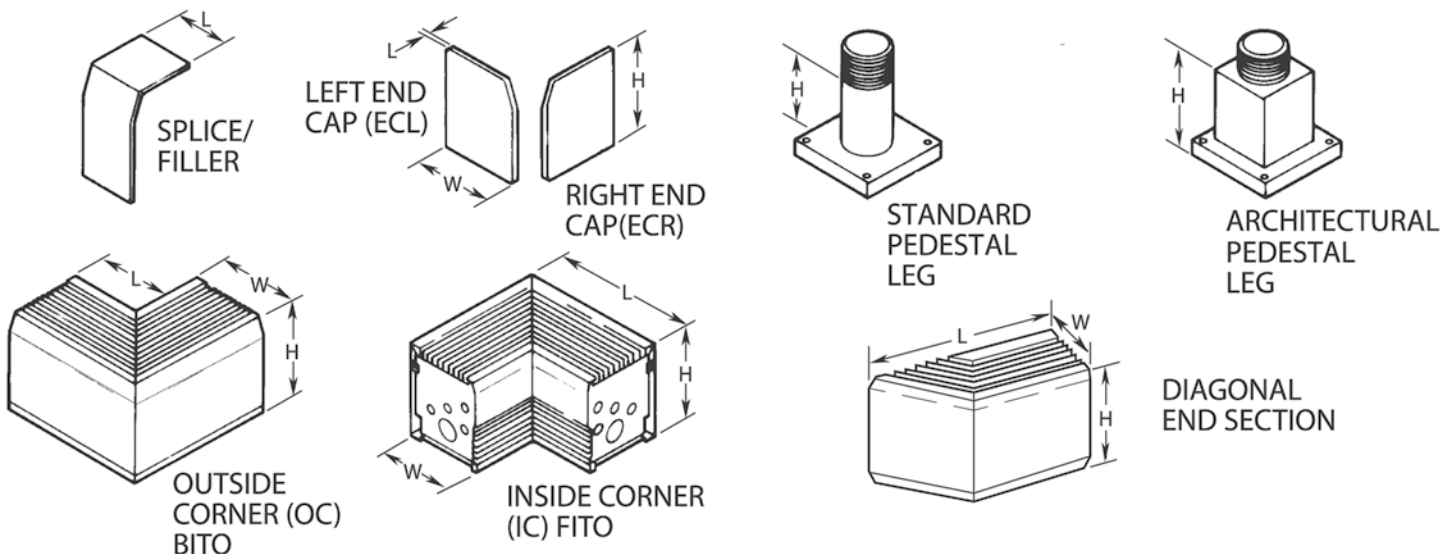

ASL3 & ASL5 SERIES

Architectural Sill-Height Convectors

Scan the QR code
to access additional
specs and features



Blank Sections & Accessories — ASL5 Series:

| CATALOG NO. | DIMENSIONS (W x H x L) | INLET | SHIP WT. | CATALOG NO. | DESCRIPTION | ADDITIONAL SPACE REQUIRED | SHIP WT. |
|-------------|------------------------|--------|----------|-------------|--------------------------------------|---------------------------|----------|
| ASL5BS1F | 5 3/8" x 7" x 1' | Front | 7 lbs | ASL5ECLS | End Cap w/Screws - Left | | |
| ASL5BS1B | | Bottom | | ASL5ECRS | End Cap w/Screws - Right | | |
| ASL5BS2F | 5 3/8" x 7" x 28" | Front | 11 lbs | ASL51CF | Inside Corner-Front In | 10" | 11 lbs |
| ASL5BS2B | | Bottom | | ASL51CB | Inside Corner-Bottom In | 10" | 11 lbs |
| ASL5BS3F | 5 3/8" x 7" x 3' | Front | 14 lbs | ASL5OCF | Outside Corner-Front In | 5" | 7 lbs |
| ASL5BS3B | | Bottom | | ASL5OCB | Outside Corner-Bottom In | 5" | 7 lbs |
| ASL5BS4F | 5 3/8" x 7" x 4' | Front | 18 lbs | ASL5135ICF | 135° Inside Corner-Front In | 10" | 11 lbs |
| ASL5BS4B | | Bottom | | ASL5135ICB | 135° Inside Corner-Bottom In | 10" | 11 lbs |
| ASL5BS5F | 5 3/8" x 7" x 5' | Front | 22 lbs | ASL5135OCF | 135° Outside Corner-Front In | 5" | 7 lbs |
| ASL5BS5B | | Bottom | | ASL5135OCB | 135° Outside Corner-Bottom In | 5" | 7 lbs |
| ASL5BS6F | 5 3/8" x 7" x 6' | Front | 27 lbs | ASL5DESB | Dec. End Section-Bot. In, Left | 12 1/2" | 11 lbs |
| ASL5BS6B | | Bottom | | ASL5DESB | Dec. End Section-Bot. In, Right | | 11 lbs |
| ASL5BS7F | 5 3/8" x 7" x 7' | Front | 32 lbs | ASL5DESFL | Dec. End Section-Front In, Left | | 7 lbs |
| ASL5BS7B | | Bottom | | ASL5DESFR | Dec. End Section-Front In, Right | | 7 lbs |
| ASL5BS8F | 5 3/8" x 7" x 8' | Front | 37 lbs | ASL5SP | Splice Plate | 0-1/4" | 1 lbs |
| ASL5BS8B | | Bottom | | ASL5FL3 | Filler Section 3 in. | 0-3" | 1 lbs |
| ASL5BS9F | 5 3/8" x 7" x 9' | Front | 40 lbs | ASL5FL6 | Filler Section 6 in. | 3-6" | 1 lbs |
| ASL5BS9B | | Bottom | | ASL5FL9 | Filler Section 9 in. | 6-9" | 2 lbs |
| ASL5BS10F | 5 3/8" x 7" x 10' | Front | 44 lbs | ASL5FL12 | Filler Section 12 in. | 9-12" | 3 lbs |
| ASL5BS10B | | Bottom | | ASL5-FL18 | Filler Section 18 in. | 15-18" | 5 lbs |
| | | | | ASL5DRF | Receptacle Section-Front In | 4 1/2" | 2 lbs |
| | | | | ASL5DRB | Receptacle Section-Bottom In | | |
| | | | | PK5S* | Standard Pedestal 4 1/8 in. (H) | - | 2 lbs |
| | | | | PK5A* | Architectural Pedestal 4 1/8 in. (H) | | |
| | | | | SO1A*** | Stand-Off Bracket | - | 1 lbs |

NOTE: Blank section grilles are not punched unless requested.

*One pedestal. Two required on units up to 10 ft., three required on units over 10ft.
 **Add suffix -P for painted followed by the color code (i.e. W for White, B for Black, etc.), -C for clear anodized, -B for bronze anodized (excludes PK5S—Black only).
 ***All Stand-off Brackets come standard as Beige.

