

This catalog contains part numbers for the most common replacement parts for QMARK heaters shown in the Table of Contents. Additional parts for these heaters may be available - consult factory for availability. Parts for QMARK heaters not listed in the Table of Contents may be available - consult factory for availability.

NOTE: Parts longer than 8' in length cannot ship UPS. Consult factory for shipping information.

TABLE OF CONTENTS

BASEBOARD	CEILING HEATERS	RADIANT
QMK (2500 Series) 2	QCH 22	ARL 43
QMKC 2	EFF 22	BRM 44
Baseboard Accessories 4	CFD 22	CRN 45
CBD 5		FFR 46
HBB 5		CHRR 46
	UNIT HEATERS	FRP & FRS 47
WALL HEATERS	CU900 23	HRK 48
SSAR 6	CHPR25 25	QHRA & QVRC 49
SSHO 7	IUH 26	RCC 50
HT 8	MEDH 27	
MCSSAR 9	MSDH 28	PORTABLE
AWH & WHFC 10	PRH 29	QPH4A 33
CWH3000 11	MUH 30	FBE 51
CWH1000 12	MWUH 32	LFP 51
CWH ARCHITECTURAL SERIES 13	MUH35 33	FHP 52
LFK 14	TBX 34	WPC 53
GFR 15	QWD 35	
QFG 16		INDUSTRIAL PRODUCTS
SED 17	CONVECTORS	AIR CIRCULATORS 54
COS-E 18	KCJ 37	DRUM BLOWERS 64
EFQ 19	DBA 38	COMMERCIAL CEILING FANS 66
ECP 20	SHA 38	EXHAUST FANS 67
	SLQDB 39	AIR CURTAINS 69
SPECIALTY HEATERS	ST 40	
QTS 21	CSH 41	
FDI 21	DSH 41	
WHT 21	CPH 41	
CFWF 21	DPH 41	
	DBSL 42	

OBSOLETE PRODUCTS

SOME PARTS MAY NO LONGER BE AVAILABLE FOR OBSOLETE PRODUCTS

BUILDER PRODUCTS (OBS)

ALL BATH VENTS 73
GENERAL HOME/KITCHEN 83
ROOF VENTILATORS 84
WHOLE HOUSE FANS 85

WALL HEATERS

AFA 86
CRA 87
QVP 88
A2500 88
1235 & 2435 89
B2400 89
CWH2000 90

UNIT HEATERS

CU-A 91
CU-B 91
VUH 92
VUH-A 92

CONVECTORS

KD/KS 93
QDB 93
ADB 94
APH 94
ASH 94

RADIANT

RDO 95
QRH 95

AIR CIRCULATORS

LCHHD 95
LCHXN 95
LCHIN 95

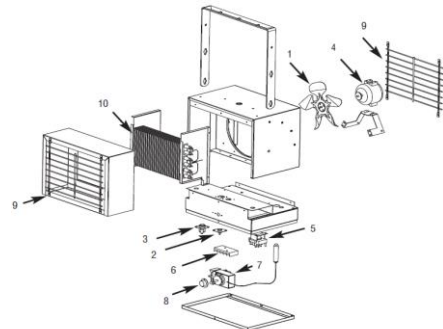









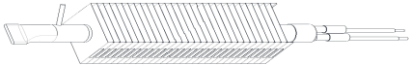

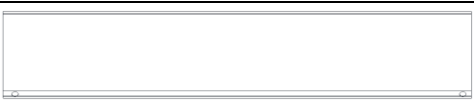
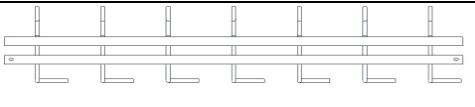
C2500 & 2500 SERIES CONTINUED





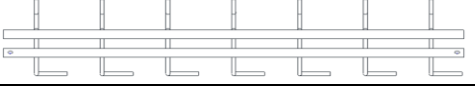



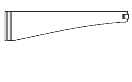
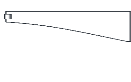

THERMAL CUTOUT





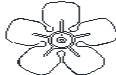
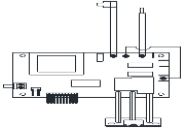

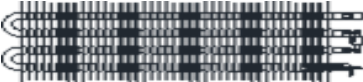
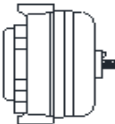

4520-2018-000	4520-2018-001	4520-2018-002	4520-2018-003	4520-2018-004	
2502 2502A 2502B 2502NWC 2502NWCA 2502W 2502WA 2502WB 2502WC 2502WCA 2512 2512A 2512B 2512NWC 2512NWCA 2512W 2512WA 2512WB 2512WC 2512WCA 2542	25026 25026A 25026B 25026NWC 25026W 25026WA 25026WB 25026WC 25026WCA 25126 25126A 25126B 25126NWC 25126W 25126WA 25126WB 25126WC 25126WCA 25426 25426A 25426B 25426NWC 25426W 25426WA 25426WB 25426WC 25426WCA 25726 25726A 25726B 25726W 25726WA 25726WB 25726WC 25726WCA	25026A 25726WB 25726WCA 25026NWC 25026W 25026WA 25026WB 25026WC 25026WCA 25126 25126A 25126B 25126NWC 25126W 25126WA 25126WB 25126WC 25126WCA 25426 25426A 25426B 25426NWC 25426W 25426WA 25426WB 25426WC 25426WCA 25726 25726A 25726B 25726W 25726WA 25726WB 25726WC 25726WCA	2503 2503A 2503B 2503NWC 2503W 2503WA 2503WB 2503WC 2503WCA 2513 2513A 2513B 2513NWC 2513W 2513WA 2513WB 2513WC 2513WCA 2543 2543A 2543B 2543NWC 2543W 2543WA 2543WB 2543WC 2543WCA 2573 2573A 2573B 2573W 2573WA 2573WB 2573WC 2573WCA	2504 2504A 2504B 2504NWC 2504W 2504WA 2504WB 2504WC 2504WCA 2514 2514A 2514B 2514NWC 2514W 2514WA 2514WB 2514WC 2514WCA 2544 2544A 2544B 2544NWC 2544W 2544WA 2544WB 2544WC 2544WCA 2574 2574A 2574B 2574W 2574WA 2574WB 2574WC 2574WCA	2505 2505A 2505B 2505NWC 2505W 2505WA 2505WB 2505WC 2505WCA 2515 2515A 2515B 2515NWC 2515W 2515WA 2515WB 2515WC 2515WCA 2545 2545A 2545B 2545NWC 2545W 2545WA 2545WB 2545WC 2545WCA 2575 2575A 2575B 2575W 2575WA 2575WB 2575WC 2575WCA
4520-2018-005	4520-2018-006	4520-2019-000	4520-2019-001	4520-2019-002	
2506 2506A 2506B 2506NWC 2506NWCA 2506W 2506WA 2506WB 2506WC 2506WCA 2516 2516A 2516B 2516NWC 2516NWCA 2516W 2516WA 2516WB 2516WC 2516WCA 2546 2546A 2546B 2546NWC 2546NWCA 2546W 2546WA 2546WB 2546WC 2546WCA 2576 2576A 2576B 2576W 2576WA 2576WB 2576WC 2576WCA	2508 2508A 2508B 2508NWC 2508NWCA 2508W 2508WA 2508WB 2508WC 2508WCA 2518 2518A 2518B 2518NWC 2518NWCA 2518W 2518WA 2518WB 2518WC 2518WCA 2548 2548A 2548B 2548NWC 2548NWCA 2548W 2548WA 2548WB 2548WC 2548WCA 2578 2578A 2578B 2578W 2578WA 2578WB 2578WC 2578WCA	2502H 2502HA 2502HB 2502HNWC 2502HWCA 2502W 2502WA 2502WB 2502WC 2502WCA 2512H 2512HA 2512HB 2512HNWC 2512HWCA 2542H 2542HA 2542HB 2542HNWC 2542HWCA 2572H 2572HA 2572HB 2572HNWC 2572HWCA	25026HA 25026HA 25026HB 25026HNWC 25026HWCA 25026W 25026WA 25026WB 25026WC 25026WCA 25126H 25126HA 25126HB 25126HNWC 25126HWCA 25426H 25426HA 25426HB 25426HNWC 25426HWCA 25726H 25726HA 25726HB 25726HNWC 25726HWCA	2503H 2503HA 2503HB 2503HNWC 2503HWCA 2503W 2503WA 2503WB 2503WC 2503WCA 2513H 2513HA 2513HB 2513HNWC 2513HWCA 2543H 2543HA 2543HB 2543HNWC 2543HWCA 2573H 2573HA 2573HB 2573HNWC 2573HWCA	
4520-2019-005	4520-2019-006	4520-2019-003	4520-2019-004		
2506H 2506HA 2506HB 2506HNWC 2506HWCA 2506W 2506WA 2506WB 2506WC 2506WCA 2516H 2516HA 2516HB 2516HNWC 2516HWCA 2546H 2546HA 2546HB 2546HNWC 2546HWCA 2576H 2576HA 2576HB 2576HNWC 2576HWCA	2508H 2508HA 2508HB 2508HNWC 2508HWCA 2508W 2508WA 2508WB 2508WC 2508WCA 2518H 2518HA 2518HB 2518HNWC 2518HWCA 2548H 2548HA 2548HB 2548HNWC 2548HWCA 2578H 2578HA 2578HB 2578HNWC 2578HWCA	2504H 2504HA 2504HB 2504HNWC 2504HWCA 2504W 2504WA 2504WB 2504WC 2504WCA 2514H 2514HA 2514HB 2514HNWC 2514HWCA 2544H 2544HA 2544HB 2544HNWC 2544HWCA 2574H 2574HA 2574HB 2574HNWC 2574HWCA	2505H 2505HA 2505HB 2505HNWC 2505HWCA 2505W 2505WA 2505WB 2505WC 2505WCA 2515H 2515HA 2515HB 2515HNWC 2515HWCA 2545H 2545HA 2545HB 2545HNWC 2545HWCA 2575H 2575HA 2575HB 2575HNWC 2575HWCA		

HBB SERIES BASEBOARD											
ELEMENT						LIMIT					
											
1802-2068-000	1802-2068-001	1802-2068-002	1802-2068-003	1802-2068-004	1802-2068-016	410122002	410122003	410122004	410122005	410122006	410122008
500D	7500D	1000D	1250D	1500D	2004D	500D	7500D	1000D	1250D	1500D	2004D
500DA	7500DA	1000DA	1250DA	1500DA	2004DA	500DA	7500DA	1000DA	1250DA	1500DA	2004DA
500DB	7500DB	1000DB	1250DB	1500DB	2004DB	500DB	7500DB	1000DB	1250DB	1500DB	2004DB
1802-2068-011	1802-2068-012	1802-2068-013	1802-2068-014	1802-2068-015	1802-2068-010	504D	7504D	1004D	1254D	1504D	2007D
504D	7504D	1004D	1254D	1504D	2008D	504DA	7504DA	1004DA	1254DA	1504DA	2007DA
504DA	7504DA	1004DA	1254DA	1504DA	2008DA	504DB	7504DB	1004DB	1254DB	1504DB	2007DB
504DB	7504DB	1004DB	1254DB	1504DB		508D	7507D	1007D	1257D	1507D	2008DB
1802-2068-005	1802-2068-006	1802-2068-007	1802-2068-008	1802-2068-009		508DA	7508D	1008D	1258D	1508D	
508D	7508D	1008D	1258D	1508D		508DA	7508DA	1008DA	1258DA	1508DA	
508DA	7508DA	1008DA	1258DA	1508DA		508DB	7508DB	1008DB	1258DB	1508DB	
508DB	7508DB	1008DB	1258DB	1508DB							
FRONT COVER						GRILLE					
											
1402-2066-000	1402-2066-001	1402-2066-002	1402-2066-003	1402-2066-004	1402-2066-005	2501-2012-012	2501-2012-013	2501-2012-014	2501-2012-015	2501-2012-010	2501-2012-011
500D	7500D	1000D	1250D	1500D	2004D	500D	7500D	1000D	1250D	1500D	2004D
500DA	7500DA	1000DA	1250DA	1500DA	2004DA	500DA	7500DA	1000DA	1250DA	1500DA	2004DA
500DB	7500DB	1000DB	1250DB	1500DB	2004DB	500DB	7500DB	1000DB	1250DB	1500DB	2004DB
504D	7504D	1004D	1254D	1504D	2007D	504D	7504D	1004D	1254D	1504D	2007D
504DA	7504DA	1004DA	1254DA	1504DA	2008D	504DA	7504DA	1004DA	1254DA	1504DA	2008DA
504DB	7504DB	1004DB	1254DB	1504DB	2008DA	504DB	7504DB	1004DB	1254DB	1504DB	2008DA
508D	7507D	1007D	1257D	1507D	2008DB	508D	7507D	1007D	1257D	1507D	2008DB
508DA	7508D	1008D	1258D	1508D		508DA	7508D	1008D	1258D	1508D	
508DB	7508DA	1008DA	1258DA	1508DA		508DB	7508DA	1008DA	1258DA	1508DA	
508DB	7508DB	1008DB	1258DB	1508DB							
JUNCTION BOX COVER ALL MODELS 1800-2022-000											
											
CBD SERIES BASEBOARD											
ELEMENT						LIMIT					
											
1802-2056-007	1802-2056-011	1802-2063-017	1802-2063-023	1802-2094-015	1802-2063-033	4520-2018-001	4520-2018-002	4520-2018-003	4520-2018-004	4520-2018-005	4520-2018-006
D500	D750	D1000	D1250	D1500	D2004	D500	D750	D1000	D1250	D1500	D2004
D500A	D750A	D1000A	D1250A	D1500A	D2004A	D500A	D750A	D1000A	D1250A	D1500A	D2004A
1802-2056-005	1802-2056-009	1802-2063-015	1802-2063-021	1802-2063-027	1802-2063-032	D504	D754	D1004	D1254	D1504	D2007
D504	D754	D1004	D1254	D1504	D2007	D504A	D754A	D1004A	D1254A	D1504A	D2007A
D504A	D754A	D1004A	D1254A	D1504A	D2007A	D507	D757	D1007	D1256A	D1507	D2008
1802-2056-004	1802-2056-008	1802-2063-014	1802-2063-047	1802-2063-026	1802-2063-034	D507A	D757A	D1007A	D1256A	D1507A	D2008A
D507	D757	D1007	D1256	D1507	D2008	D507A	D757A	D1007A	D1256A	D1507A	D2008A
D507A	D757A	D1007A	D1256A	D1507A	D2008A	D508	D758	D1008	D1257A	D1508	
1802-2056-006	1802-2056-010	1802-2063-016	1802-2063-020	1802-2063-028		D508A	D758A	D1008A	D1257A	D1508A	
D508	D758	D1008	D1257	D1508		D508A	D758A	D1008A	D1257A	D1508A	
D508A	D758A	D1008A	D1257A	D1508A							
			1802-2063-022								
			D1258								
			D1258A								
FRONT COVER						GRILLE					
											
1402-2066-010	1402-2066-011	1402-2066-012	1402-2066-013	1402-2066-014	1402-2066-015	2501-2012-012	2501-2012-013	2501-2012-014	2501-2012-015	2501-2012-010	2501-2012-011
D500	D750	D1000	D1250	D1500	D2004	D500	D750	D1000	D1250	D1500	D2004
D500A	D750A	D1000A	D1250A	D1500A	D2004A	D500A	D750A	D1000A	D1250A	D1500A	D2004A
D504	D754	D1004	D1254	D1504	D2007	D504	D754	D1004	D1254	D1504	D2007
D504A	D754A	D1004A	D1254A	D1504A	D2007A	D504A	D754A	D1004A	D1254A	D1504A	D2007A
D507	D757	D1007	D1256	D1507	D2008	D507A	D757A	D1007A	D1256A	D1507A	D2008A
D507A	D757A	D1007A	D1256A	D1507A	D2008A	D508	D758	D1008	D1257A	D1508	
D508	D758	D1008	D1257	D1508		D508A	D758A	D1008A	D1257A	D1508A	
D508A	D758A	D1008A	D1257A	D1508A							
			D1258								
			D1258A								
JUNCTION BOX COVER ALL MODELS 1800-2022-000											
											
SEE ACCESSORIES ON 2500 SERIES PAGE FOR T1 & T2 THERMOSTAT PARTS											

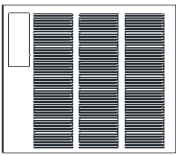
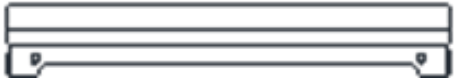

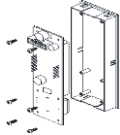
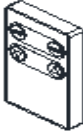
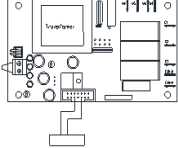
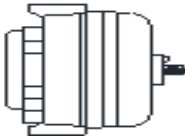

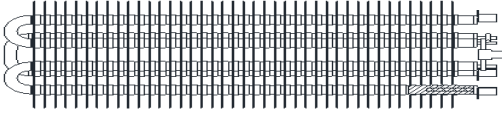
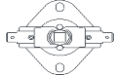

SSAR SERIES

RIGHT BEZEL	LEFT BEZEL	DISPLAY ASSM.	BOTTOM BRACKET LT.	BOTTOM BRACKET RT.	REMOTE	EOL LIMIT	FAN BLADE
							
1219-11009-001 ALL MODELS	1219-11009-000 ALL MODELS	1016-11188-000 ALL MODELS	1215-11070-000 ALL MODELS	1215-11070-001 ALL MODELS	1414-11037-000 ALL MODELS	1414-11046-000 ALL MODELS	490030103 ALL MODELS
PWR CONTROL BOARD			DISCONNECT SWITCH	ELEMENT			
							
1414-11033-002 ARWH1802 ARWH1802AL ARWH1802BZ ARWH1802W	1414-11033-001 ARWH4807 ARWH4807AL ARWH4807BZ ARWH4807W	1414-11033-000 ARWH4808 ARWH4804 ARWH4808AL ARWH4804AL ARWH4808BZ ARWH4804BZ ARWH4808W ARWH4804W	410170001 ARWH1802 ARWH1802AL ARWH1802BZ ARWH1802W ARWH4804 ARWH4804AL ARWH4804BZ ARWH4808W ARWH4804W ARWH4807 ARWH4807AL ARWH4807BZ ARWH4807W	302012828 ARWH1802 ARWH1802AL ARWH1802BZ ARWH1802W	1802-2075-801 ARWH4808 ARWH4808AL ARWH4808BZ ARWH4808W	302012810 ARWH4804 ARWH4804AL ARWH4804BZ ARWH4804W	302012811 ARWH4807 ARWH4807AL ARWH4807BZ ARWH4807W
MOTOR							
3900-11026-002 ARWH1802 ARWH1802AL ARWH1802BZ ARWH1802W	3900-11026-001 ARWH4807 ARWH4807AL ARWH4807BZ ARWH4807W	3900-11026-000 ARWH4808 ARWH4804 ARWH4808AL ARWH4804AL ARWH4808BZ ARWH4804BZ ARWH4808W ARWH4804W					
							

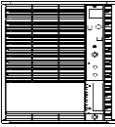
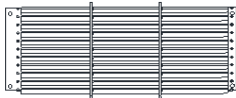
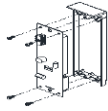
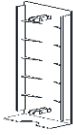

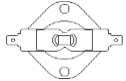
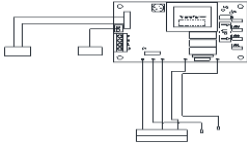
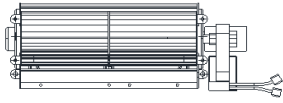



SSHO SERIES



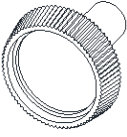
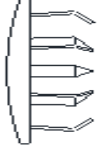
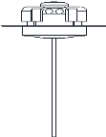

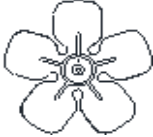

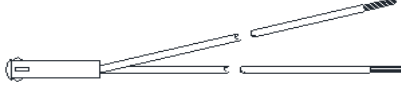
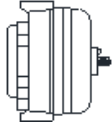
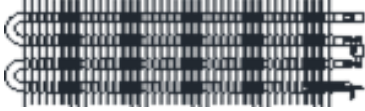





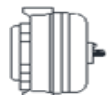

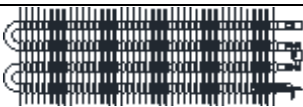
GRILLE			GRILLE TABS (2 REQ)			LIGHT
						
2501-11022-000 HOSS4004 HOSS4007 HOSS4008	2501-11022-001 HOSS4004SB HOSS4007SB HOSS4008SB	2501-11022-002 HOSS4004NV HOSS4007NV HOSS408NV	1402-2120-002 HOSS4004 HOSS4007 HOSS4008	1402-2120-001 HOSS4004SB HOSS4007SB HOSS4008SB	1402-2120-000 HOSS4004NV HOSS4007NV HOSS408NV	3510-2017-005 ALL MODELS
DISPLAY ASSM.	REMOTE	CTRL PWR BOARD		MOTOR		DISCONNECT SWITCH
						
1016-11199-000 ALL MODELS	1414-11037-000 ALL MODELS	1414-11043-000 HOSS4004 HOSS4004NV HOSS4004SB HOSS4008 HOSS408NV HOSS4008SB	1414-11043-001 HOSS4007 HOSS4007NV HOSS4007SB	3900-2002-522 HOSS4004 HOSS4004NV HOSS4004SB HOSS4008 HOSS408NV HOSS4008SB	3900-2002-523 HOSS4007 HOSS4007NV HOSS4007SB	410170001 ALL MODELS
ELEMENT			MANUAL LIMIT	FAN BLADE		
						
1802-11005-000 HOSS4008 HOSS408NV HOSS4008SB	1802-11005-001 HOSS4004 HOSS4004NV HOSS4004SB	1802-11005-002 HOSS4007 HOSS4007NV HOSS4007SB	4520-2027-000 ALL MODELS	490030103 ALL MODELS		

HT SMART SERIES

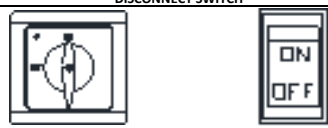

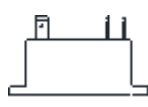







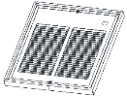
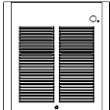

GRILLE PANEL		GRILLE ASSY INSERT		DISPLAY BEZEL	BOTTOM BEZEL	REMOTE	MANUAL LIMIT
							
2501-11003-003 HT1502SS HT2024SS	2501-11003-004 HT1502SSNW HT2024SSNW	1016-11063-000 HT1502SS HT2024SS	1016-11063-001 HT1502SSNW HT2024SSNW	1016-11035-003 HT1502SS HT2024SS HT1502SSNW HT2024SSNW	1219-11004-000 ALL MODELS	1414-11017-001 ALL MODELS	4520-11005-000 ALL MODELS
CNTRL PWR BOARD		BLOWER MOTOR		ELEMENT		LIGHT	
							
1414-11007-002 HT1502SS HT1502SSNW	1414-11007-003 HT2024SS HT2024SSNW	1225-11001-000 HT1502SS HT1502SSNW	1225-11001-001 HT2024SS HT2024SSNW	302023802 HT1502SS HT1502SSNW	302023805 HT2024SS HT2024SSNW	3510-2010-000 HT1502SS HT1502SSNW	3510-2010-001 HT2024SS HT2024SSNW
							

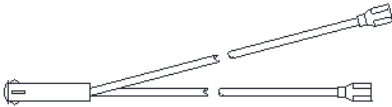
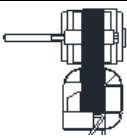
MCSSAR SERIES

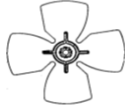

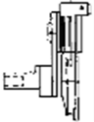

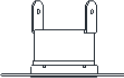





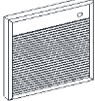

KNOB	PLUG BUTTON	MANUAL RESET	THERMAL FUSE	FAN BLADE	THERMOSTAT
					
3301-11013-000 ALL MODELS	4506-2012-009 ALL MODELS	4520-11019-000 ALL MODELS	4520-2030-000 ALL MODELS	490030103 ALL MODELS	5813-2027-001 ALL MODELS
FAN DELAY			LIGHT		
					
1414-2039-000 MCARWH1802 MCARWH1802AL MCARWH1802BZ MCARWH1802W	410074000 MCARWH4804 MCARWH4804AL MCARWH4804BZ MCARWH4804W MCARWH4807 MCARWH4807AL MCARWH4807AL	MCARWH4807BZ MCARWH4807W MCARWH4808 MCARWH4808AL MCARWH4808BZ MCARWH4808W	3510-2017-000 MCARWH1802 MCARWH1802AL MCARWH1802BZ MCARWH1802W	3510-2017-001 MCARWH4804 MCARWH4804AL MCARWH4804BZ MCARWH4804W MCARWH4807 MCARWH4807AL	MCARWH4807BZ MCARWH4807W MCARWH4808 MCARWH4808AL MCARWH4808BZ MCARWH4808W
MOTOR			ELEMENT		DISCONNECT SWITCH
					
3900-2010-003 MCARWH1802 MCARWH1802AL MCARWH1802BZ MCARWH1802W	3900-2010-000 MCARWH4804 MCARWH4804AL MCARWH4804BZ MCARWH4804W MCARWH4808 MCARWH4808AL MCARWH4808BZ MCARWH4808W	3900-2010-001 MCARWH4807 MCARWH4807AL MCARWH4807BZ MCARWH4807W	302012828 MCARWH1802 MCARWH1802AL MCARWH1802BZ MCARWH1802W 302012811 MCARWH4807 MCARWH4807AL MCARWH4807BZ MCARWH4807W	302012810 MCARWH4804 MCARWH4804AL MCARWH4804BZ MCARWH4804W 302012807 MCARWH4808 MCARWH4808AL MCARWH4808BZ MCARWH4808W	410170001 ALL MODELS 

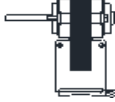





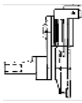







CWH3000 SERIES																			
KNOB				GRILLE				MOTOR		FAN BLADE									
																			
3301-11014-001 WHB3150FC WHB3180C WHB3307FC WHB3404FC WHB34043FC WHB3407FC WHB3408FC WHB34083FC WHB3504FC WHB35043FC WHB3507FC WHB3508FC WHB35083FC		3301-2016-000 CWH3157A CWH3204A CWH3207A CWH3208A CWH3307A CWH3404A CWH3407A CWH3408A CWH3504A CWH3507A CWH3157A CWH3204A CWH3207A CWH3208A CWH3307A CWH3404A CWH3407A CWH3408A CWH3504A CWH3507A		CWH34043 CWH3406 CWH34083 CWH3503 CWH35043 CWH3506 CWH35083 CWH3150 CWH3180 CWH3153B CWH3156B CWH3157B CWH3203B CWH3204B CWH3206B CWH3207B CWH3208B CWH3303B CWH3306B CWH3307B		1016-11226-000 WHB3150FC WHB3180C WHB3307FC WHB3404FC WHB34043FC WHB3407FC WHB3408FC WHB34083FC WHB3504FC WHB35043FC WHB3507FC WHB3508FC WHB35083FC		2501-2019-001 CWH3157A CWH3204A CWH3207A CWH3208A CWH3307A CWH3404A CWH3407A CWH3408A CWH3504A CWH3507A CWH3153B CWH3156B CWH3157B CWH3203B CWH3206B CWH3207B CWH3208B CWH3303B CWH3306B		3900-2010-001 CWH3157A CWH3207A CWH3307A CWH3407A CWH3507A CWH3157A CWH3207A CWH3307A CWH3407A CWH3507A CWH3157B CWH3207B CWH3307B CWH3407B CWH3507B WHB3307FC WHB3407FC WHB3507FC		3900-2010-000 CWH3204A CWH3208A CWH3404A CWH3408A CWH3504A CWH3204A CWH3208A CWH3404A CWH3408A CWH3504A CWH3153B CWH3156B CWH3203B CWH3206B CWH3404A CWH3408A CWH3504A CWH3507A		3900-2010-003 CWH3150 CWH3180 WHB3150FC WHB3180C 3900-2002-510 CWH3153B CWH3156B CWH3203B CWH3206B 3900-2002-519 CWH3406 CWH3503 CWH3506 CWH3204B CWH3208B CWH3404B CWH3408B CWH3504B WHB3404FC WHB3408FC WHB3504FC		3900-2002-518 CWH34043 CWH34083 CWH35043 CWH35083 CWH34043B CWH34083B CWH35043B CWH35083B WHB34043FC WHB34083FC WHB35043FC WHB35083FC		490030103 ALL MODELS	
ELEMENT 				THERMOSTAT 				MANUAL LIMIT 		TIME DELAY RELAY 									
302015801 CWH3208A CWH3208A CWH3208B		302015802 CWH3204A CWH3204A CWH3208B		302015803 CWH3207A CWH3207A CWH3207B		302015806 CWH3157A CWH3157A CWH3157B		1802-2075-801 CWH35083 CWH3508B CWH35083B WHB3508FC WHB35083FC		410168002 CWH3157A CWH3204A CWH3207A CWH3208A CWH3307A CWH3404A CWH3407A CWH3408A CWH3504A CWH3507A CWH3157A CWH3204A CWH3207A CWH3208A CWH3307A CWH3404A CWH3407A CWH3408A CWH3504A CWH3507A		5813-2059-000 CWH3150 CWH3180 CWH3153B CWH3156B CWH3157B CWH3203B CWH3204B CWH3206B CWH3207B CWH3208B CWH3303B CWH3306B CWH3307B CWH3308B CWH3404B CWH3404B CWH3406B CWH3407B CWH3408B CWH35083B CWH3503B		4520-2027-000 ALL MODELS		410171003 CWH3203B CWH3206B			
302012806 CWH3307A CWH3307A CWH3307B CWH3307B WHB3307FC		302012807 CWH3408A CWH3408A CWH3408B CWH3408B WHB3408FC		302012808 CWH3404A CWH3404A CWH3408B CWH3404B WHB3404FC		302012809 CWH3407A CWH3407A CWH3407B CWH3407B WHB3407FC		1802-2075-803 CWH35043 CWH35043B WHB35043FC		410168002 CWH3157A CWH3204A CWH3207A CWH3208A CWH3307A CWH3404A CWH3407A CWH3408A CWH3504A CWH3507A CWH3157A CWH3204A CWH3207A CWH3208A CWH3307A CWH3404A CWH3407A CWH3408A CWH3504A CWH3507A		5813-2059-000 CWH3150 CWH3180 CWH3153B CWH3156B CWH3157B CWH3203B CWH3204B CWH3206B CWH3207B CWH3208B CWH3303B CWH3306B CWH3307B CWH3308B CWH3404B CWH3404B CWH3406B CWH3407B CWH3408B CWH35083B CWH3503B		4520-2027-000 ALL MODELS		410171003 CWH3203B CWH3206B			
302012810 CWH3504A CWH3504A CWH3504B CWH3504B WHB3504FC		302012811 CWH3507A CWH3507A CWH3507B CWH3507B WHB3507FC		302012823 CWH3503 CWH3503B 302012824 CWH34083		302012828 CWH3180 WHB3180C 1802-2075-800 CWH34083		1802-2075-803 CWH35043 CWH35043B WHB35043FC		410168002 CWH3157A CWH3204A CWH3207A CWH3208A CWH3307A CWH3404A CWH3407A CWH3408A CWH3504A CWH3507A CWH3157A CWH3204A CWH3207A CWH3208A CWH3307A CWH3404A CWH3407A CWH3408A CWH3504A CWH3507A		5813-2059-000 CWH3150 CWH3180 CWH3153B CWH3156B CWH3157B CWH3203B CWH3204B CWH3206B CWH3207B CWH3208B CWH3303B CWH3306B CWH3307B CWH3308B CWH3404B CWH3404B CWH3406B CWH3407B CWH3408B CWH35083B CWH3503B		4520-2027-000 ALL MODELS		410171003 CWH3203B CWH3206B			
302012816 CWH3156B CWH3156B CWH3206B		302012820 CWH3306B CWH3153B CWH3506B		302012821 CWH3506B CWH34043		302012827 CWH3150 CWH34043B WHB34043FC		1802-2075-802 CWH34043		410168002 CWH3157A CWH3204A CWH3207A CWH3208A CWH3307A CWH3404A CWH3407A CWH3408A CWH3504A CWH3507A CWH3157A CWH3204A CWH3207A CWH3208A CWH3307A CWH3404A CWH3407A CWH3408A CWH3504A CWH3507A		5813-2059-000 CWH3150 CWH3180 CWH3153B CWH3156B CWH3157B CWH3203B CWH3204B CWH3206B CWH3207B CWH3208B CWH3303B CWH3306B CWH3307B CWH3308B CWH3404B CWH3404B CWH3406B CWH3407B CWH3408B CWH35083B CWH3503B		4520-2027-000 ALL MODELS		410171003 CWH3203B CWH3206B			
302012818 CWH3206B CWH3206B CWH3303B		302012821 CWH3308B CWH3150 CWH3406 CWH3406B		302012827 CWH3150 CWH34043B WHB34043FC		1802-2075-802 CWH34043		1802-2075-803 CWH35043 CWH35043B WHB35043FC		410168002 CWH3157A CWH3204A CWH3207A CWH3208A CWH3307A CWH3404A CWH3407A CWH3408A CWH3504A CWH3507A CWH3157A CWH3204A CWH3207A CWH3208A CWH3307A CWH3404A CWH3407A CWH3408A CWH3504A CWH3507A		5813-2059-000 CWH3150 CWH3180 CWH3153B CWH3156B CWH3157B CWH3203B CWH3204B CWH3206B CWH3207B CWH3208B CWH3303B CWH3306B CWH3307B CWH3308B CWH3404B CWH3404B CWH3406B CWH3407B CWH3408B CWH35083B CWH3503B		4520-2027-000 ALL MODELS		410171003 CWH3203B CWH3206B			
DISCONNECT SWITCH 				FAN DELAY 				RELAY 		TRANSFORMER 									
5216-2019-000 CWH34043 CWH3406 CWH34083 CWH3503 CWH35043 CWH3506 CWH35083 CWH3153B CWH3156B CWH3203B CWH3206B CWH3303B CWH3306B CWH3308B CWH34043B CWH3406B CWH34083B CWH3503B CWH35043B CWH3506B CWH3508B		410170001 CWH3157A CWH3204A CWH3207A CWH3208A CWH3307A CWH3404A CWH3407A CWH3408A CWH3504A CWH3507A CWH3157A CWH3204A CWH3207A CWH3208A CWH3307A CWH3404A CWH3407A CWH3408A CWH3504A CWH3507A		4520-2024-000 CWH34043 CWH34083 CWH35043 CWH35083 CWH3153B CWH3156B		410074000 CWH3157A CWH3204A CWH3207A CWH3208A CWH3307A CWH3404A CWH3407A CWH3408A CWH3504A CWH3507A CWH3157A CWH3204A CWH3207A CWH3208A CWH3307A CWH3404A CWH3407A CWH3408A CWH3504A CWH3507A		5018-2017-000 CWH3506B CWH3507B CWH3508B WHB3150FC WHB3180C WHB3307FC WHB3404FC WHB34043FC WHB3407FC WHB3408FC WHB34083FC WHB3504FC WHB35043FC WHB3507FC WHB3508FC WHB35083FC		5018-2017-004 CWH34083 CWH35083 CWH34083B CWH3508B CWH35083B CWH35083B CWH35083B CWH35083B CWH35083B CWH35083B CWH35083B CWH35083B CWH35083B CWH35083B CWH35083B CWH35083B CWH35083B CWH35083B CWH35083B CWH35083B CWH35083B		490015017 CWH3156B CWH3206B CWH3306B CWH3406B CWH3506B CWH3156B CWH3206B CWH3306B CWH3406B CWH3506B		490015013 CWH3153B CWH3203B CWH3303B CWH3403B CWH3503B CWH3153B CWH3203B CWH3303B CWH3403B CWH3503B					
WHB 				CWH 															







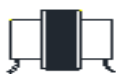
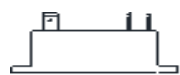



CWH1000 SERIES





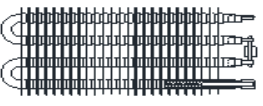
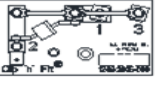

GRILLE		KNOB		ELEMENT		
						
2501-2058-000 CWH1101DS CWH1151DS CWH1157DS CWH1201DS CWH1202DS CWH1207DS CWH1208DS CWH1101DSA CWH1151DSA CWH1157DSA CWH1201DSA CWH1202DSA CWH1207DSA CWH1208DSA	1016-11228-000 WHB1101FC WHB1151FC WHB1157FC WHB1201FC WHB1202FC WHB1207FC WHB1208FC	3301-2001-000 CWH1101DS CWH1151DS CWH1157DS CWH1201DS CWH1202DS CWH1207DS CWH1208DS CWH1101DSA CWH1151DSA CWH1157DSA CWH1201DSA CWH1202DSA CWH1207DSA CWH1208DSA	3301-11015-001 WHB1101FC WHB1151FC WHB1157FC WHB1201FC WHB1202FC WHB1207FC WHB1208FC	302023801 CWH1101DS CWH1101DSA WHB1101FC 302023804 CWH1208DS CWH1208DSA WHB1208FC 302023808 CWH1201DS CWH1201DSA WHB1201FC	302023802 CWH1151DS CWH1151DSA WHB1151FC 302023805 CWH1202DS CWH1202DSA WHB1202FC	302023803 CWH1157DS CWH1157DSA WHB1157FC 302023806 CWH1207DS CWH1207DSA WHB1207FC
LIGHT		MOTOR		DISCONNECT SWITCH	FAN BLADE	
						
3510-2017-007 CWH1101DS CWH1151DS CWH1201DS CWH1101DSA CWH1151DSA CWH1201DSA WHB1101FC WHB1151FC WHB1201FC	3510-2017-006 CWH1157DS CWH1157DSA CWH1207DS CWH1207DSA CWH1202DS CWH1202DSA CWH1208DS CWH1208DSA WHB1157FC WHB1202FC WHB1207FC WHB1208FC	490062001 CWH1101DS CWH1151DS CWH1201DS CWH1101DSA CWH1151DSA CWH1201DSA WHB1101FC WHB1151FC WHB1201FC 490062002 CWH1208DS CWH1208DSA CWH1208FC	490062003 CWH1202DS CWH1202DSA WHB1202FC 490062004 CWH1157DS CWH1207DS CWH1157DSA CWH1207DSA WHB1157FC WHB1207FC	410170001 ALL MODELS <div style="display: flex; justify-content: space-around;"> <div style="text-align: center;"> CWH  </div> <div style="text-align: center;"> WHB  </div> </div>	490061001 ALL MODELS	
THERMOSTAT	THERMAL FUSE	FAN DELAY	HI LIMIT	MANUAL LIMIT		
						
5813-2001-000 CWH1101DS CWH1151DS CWH1157DS CWH1202DS CWH1207DS CWH1208DS CWH1101DSA CWH1151DSA CWH1157DSA CWH1202DSA CWH1207DSA CWH1208DSA WHB1101FC WHB1151FC WHB1157FC WHB1202FC WHB1207FC WHB1208FC	5813-2022-000 CWH1201DS CWH1201DSA WHB1201FC	4520-2030-000 CWH1101DSA CWH1151DSA CWH1157DSA CWH1201DSA CWH1202DSA CWH1207DSA CWH1208DSA WHB1101FC WHB1151FC WHB1157FC WHB1201FC WHB1202FC WHB1207FC WHB1208FC	410074000 ALL MODELS	410143000 CWH1101DS CWH1151DS CWH1157DS CWH1201DS CWH1202DS CWH1207DS CWH1208DS	4520-11016-000 CWH1101DSA CWH1151DSA CWH1157DSA CWH1201DSA CWH1202DSA CWH1207DSA CWH1208DSA WHB1101FC WHB1151FC WHB1157FC WHB1201FC WHB1202FC WHB1207FC WHB1208FC	



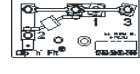

CWH ARCHITECTURAL SERIES (SWH)

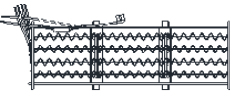
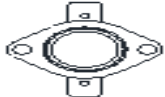
KNOB		GRILLE		ELEMENT		
						
3301-11015-003 SWH1012FC SWH1512FC SWH1527FC SWH1812FC SWH2020FC SWH2024FC SWH2027FC	3301-2052-002 SWH1012AG SWH1512AG SWH1527AG SWH1812AG SWH2020AG SWH2024AG SWH2027AG SWH1012AGA SWH1512AGA SWH1527AGA SWH1812AGA SWH2020AGA SWH2024AGA SWH2027AGA	1016-11227-000 SWH1012FC SWH1512FC SWH1527FC SWH1812FC SWH2020FC SWH2024FC SWH2027FC	2501-2075-000 SWH1012AG SWH1512AG SWH1527AG SWH1812AG SWH2020AG SWH2024AG SWH2027AG SWH1012AGA SWH1512AGA SWH1527AGA SWH1812AGA SWH2020AGA SWH2024AGA SWH2027AGA	302023801 SWH1012AG SWH1012AGA SWH1012FC 302023804 SWH2020AG SWH2020AGA SWH2020FC 302023808 SWH1812AG SWH1812AGA SWH1812FC	302023802 SWH1512AG SWH1512AGA SWH1512FC 302023805 SWH2024AG SWH2024AGA SWH2024FC	302023803 SWH1527AG SWH1527AGA SWH1527FC 302023806 SWH2027AG SWH2027AGA SWH2027FC
LIGHT				MOTOR	DISCONNECT SWITCH	
						
3510-2008-002 SWH1527AG	3510-2008-003 SWH1012AG SWH1512AG SWH1812AG SWH2020AG SWH2024AG SWH2027AG	3510-2017-007 SWH1012AGA SWH1512AGA SWH1812AGA SWH1012FC SWH1512FC SWH1812FC	3510-2017-006 SWH1527AGA SWH2020AGA SWH2024AGA SWH2027AGA SWH1527FC SWH2020FC SWH2024FC SWH2027FC	490062001 SWH1012AG SWH1512AG SWH1812AG SWH1012AGA SWH1512AGA SWH1812AGA SWH1012FC SWH1512FC SWH1812FC 490062002 SWH2020AG SWH2020AGA SWH2020FC	490062003 SWH2024AG SWH2024AGA SWH2024FC 490062004 SWH1527AG SWH2027AG SWH1527AGA SWH2027AGA SWH1527FC SWH2027FC	410170001 ALL MODELS
FAN DELAY	HI LIMIT	MANUAL LIMIT	FAN BLADE	THERMAL FUSE	THERMOSTAT	
						
410074000 ALL MODELS	410143000 SWH1012AG SWH1512AG SWH1527AG SWH1812AG SWH2020AG SWH2024AG SWH2027AG	4520-11016-000 SWH1012AGA SWH1512AGA SWH1527AGA SWH1812AGA SWH2020AGA SWH2024AGA SWH2027AGA SWH1012FC SWH1512FC SWH1527FC SWH1812FC SWH2020FC SWH2024FC SWH2027FC	490061001 ALL MODELS	4520-2030-000 SWH1012AGA SWH1512AGA SWH1527AGA SWH1812AGA SWH2020AGA SWH2024AGA SWH2027AGA SWH1012FC SWH1512FC SWH1527FC SWH1812FC SWH2020FC SWH2024FC SWH2027FC	5813-2022-000 SWH1812AG SWH1812AGA SWH1812FC	5813-2001-000 SWH1012AG SWH1512AG SWH1527AG SWH2020AG SWH2024AG SWH2027AG SWH1012AGA SWH1512AGA SWH1527AGA SWH2020AGA SWH2024AGA SWH2027AGA SWH1012FC SWH1512FC SWH1527FC SWH2020FC SWH2024FC SWH2027FC
SWH-AG 	SWH-FC 					



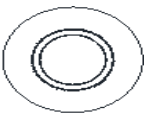

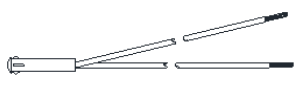
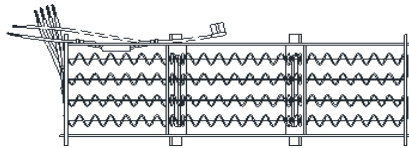
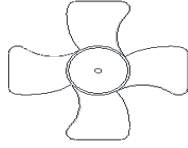
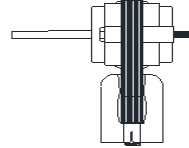
LFK-SERIES									
GRILLE			KNOB			FAN DELAY			MANUAL LIMIT
									
1402-2239-000	1402-2152-000	2501-11028-000	3301-2030-001		3301-11014-001	4520-2024-000	410074000		4520-2027-000
K151 K157A K204A K207A K208A K303A K304A K306A K307A K403A K404A K4043A K406A K407A K408A K4083A K483A K484A K4843A K486A K487A K488A K4883A	K204 K207 K208 K303 K304 K306 K307 K403 K404 K4043 K406 K408 K4083 K483 K484 K4843 K486A K487A K488 K4883	K151FC K204FC K208 K303FC K304FC K306FC K403FC K404FC K406FC K408FC K4083FC K483FC K484FC K486FC K487FC K488FC K4883FC	K151 K204 K207 K208 K303 K304 K306 K307 K403 K404 K4043 K406 K408 K4083 K483 K484 K4843 K486 K487 K488 K4883 K157A	K204A K207A K303FC K304 K306A K307A K403A K404A K4043A K406A K407A K408A K4083A K483A K484A K4843A K486A K487A K488A K4883A	K151FC K204FC K303FC K304FC K306FC K403FC K404FC K406FC K408FC K4083FC K483FC K484FC K486FC K487FC K488FC K4883FC	K4043 K4043A K4083 K4083A K4083FC K4843 K4843A K488 K4883 K4883FC	K204 K204A K204FC K208 K208A K303 K303A K303FC K306A K307A K403 K403A K403FC K406 K406A K406FC K407A K407A K408 K408A K4083 K4083A K4083FC K483 K483A K483FC K484 K484A K4843 K4843A K486 K486A K486FC K487 K487A K487FC K488 K488A K4883 K4883A K4883FC	K406FC K408 K408A K408FC K483 K483A K483FC K484 K484A K4843 K4843A K486 K486A K486FC K487 K487A K487FC K488 K488A K4883 K4883A K4883FC	ALL MODELS
ELEMENTS				MOTOR			FAN BLADE		
									
302012827	302015802	302015803	302015801	3900-2010-003	3900-2010-000		3900-2010-001	3900-2002-518	490030103
K151 K151FC	K204 K204A K204FC	K207 K207A	K208 K208A	K151 K151FC	K204 K204A K204FC K208 K208A K303 K303A K303FC K304 K304A K304FC K306A K306A K306FC K307 K307A K403 K403A K403FC K404 K404A K404FC K406 K406A K406FC K407A K407A K408 K408A K4083 K4083A K4083FC K483 K483A K483FC K484 K484A K4843 K4843A K486 K486A K486FC K487 K487A K487FC K488 K488A K4883 K4883A K4883FC	K207 K207A K304 K304A K304FC K407A K404 K404A K404FC K408 K408A K4083 K4083A K4083FC K484 K484A K4843 K4843A K486 K486A K486FC K487 K487A K487FC K488 K488A K4883 K4883A K4883FC	K307 K307A K403 K403A K403FC K404 K404A K404FC K406 K406A K406FC K407A K407A K408 K408A K4083 K4083A K4083FC K483 K483A K483FC K484 K484A K4843 K4843A K486 K486A K486FC K487 K487A K487FC K488 K488A K4883 K4883A K4883FC	K207 K207A K307 K307A K487 K487A K487FC K157A K407A	K4043 K4043A K4083 K4083A K4083FC K4843 K4843A K488 K4883 K4883A K4883FC
302012819	302012820	302012809	302012806						
K303 K303A K303FC	K204FC K306 K306A K306FC	K304 K304A K304FC K407A	K307 K307A K403 K404A K404FC						
302012821	1802-2075-802	1802-2075-800	302012808						
K403 K403A K403FC	K4043 K4043A	K4083 K4083A K4083FC	K404 K404A K404FC						
302012822	302012823	302012810	302012807						
K406 K406A K406FC	K483 K483A K483FC	K484 K484A K4843 K4843A	K408 K408A K4083 K4083A K4083FC						
302012824	302012811	1802-2075-801	1802-2075-803						
K486 K486A K486FC	K487 K487A K487FC	K488 K4883 K4883A K4883FC	K4843 K4843A						
302015806									
K157A									
THERMOSTAT			TRANSFORMER			RELAY			LFK-F
									
410168002	5813-2027-000		490015017	490015013	5018-2017-000	5018-2017-004			
K4043 K4043A K4843 K4843A	K204 K204A K204FC K208 K208A K303 K303A K303FC K304 K304A K304FC K306 K306A K306FC K403 K403A K403FC K404 K404A	K404FC K406 K406A K406FC K408 K408A K408A K408FC K483 K483A K483A K483FC K484 K484A K484A K4843 K4843A K486 K486A K486A K486FC K487 K487A K487A K487FC K488 K488A K488A K4883 K4883A K4883A K4883FC K207	K207A K307 K307A K487 K487A K487FC K157A K407A K4083 K4083A K4083A K4083FC K488 K488A K488A K4883 K4883A K4883A K4883FC	K303 K403 K483 K303A K403A K483A K303FC K403FC K483FC	K306 K406 K486 K306A K406A K486A K306FC K406FC K486FC	K4043 K4043A K4843 K4843A	K4083 K4083A K4083FC K488 K4883 K488A K4883A K488FC K4883FC		
									

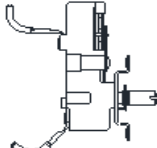
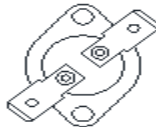



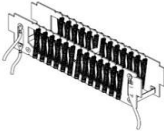
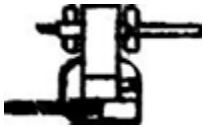



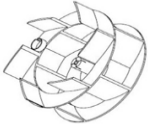

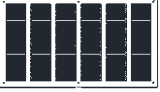
GFR SERIES								
KNOB		GRILLE			LIGHT			
								
3301-2014-004 R1500T2 R2004T2 R2404T2 R1500T2A R2004T2A R2404T2A R1500T2B R2004T2B R2404T2B	3301-11015-002 R1500T2FC R2004T2FC R2404T2FC	2501-11031-000 R1500FC R1500T2FC R2004FC R2004IFFC R2004T2FC R2404FC R2404IFFC R2404T2FC	2501-2026-000 R1500 R1500T2 R2004 R2004IF R2004T2 R2404 R2404IF R2404T2 R1500A R1500T2A R2004A R2004IFA R2004T2B R2404B R2404IFB R2404T2B		3510-2010-000 R1500 R1500T2 R1500A R1500T2A R1500B R1500T2B R1500FC R1500T2FC	3510-2010-001 R2004 R2004IF R2004T2 R2004A R2004IFA R2004T2A R2004B R2004IFB R2004T2B R2004FC R2004IFFC R2004T2FC		R2404 R2404IF R2404T2 R2404A R2404IFA R2404T2A R2404B R2404IFB R2404T2B R2404FC R2404IFFC R2404T2FC
BLOWER ASM. 				ELEMENT 			CLIP N FIT BOARD 	
1225-2000-000 R1500 R1500T2 R1500A R1500T2A R1500B R1500T2B R1500FC R1500T2FC	1225-2002-001 R2404A R2404IFA R2404T2A R2404B R2404IFB R2404T2B R2404FC R2404IFFC R2404T2FC	1225-2000-001 R2004 R2004IF R2004T2 R2404 R2404IF R2404T2 R2004A R2004IFA R2004T2A		302023802 R1500 R1500T2 R1500A R1500T2A R1500B R1500T2B R1500FC R1500T2FC	302023805 R2004 R2004IF R2004T2 R2004A R2004IFA R2004T2A R2004B R2004IFB R2004T2B R2004FC R2004IFFC R2004T2FC	302023809 R2404 R2404IF R2404T2 R2404A R2404IFA R2404T2A R2404B R2404IFB R2404T2B R2404FC R2404IFFC R2404T2FC	1249-2005-000 ALL MODELS	
THERMOSTAT 	TEMPERATURE REGULATOR 			HI-LIMIT 				
410130001 R1500T2 R2004T2 R2404T2 R1500T2A R2004T2A R2404T2A R1500T2B R2004T2B R2404T2B R1500T2FC R2004T2FC R2404T2FC	410143000 R1500 R1500T2 R2004 R2004IF R2004T2 R1500A R1500T2A R2004A R2004IFA R2004T2A		4520-2029-000 R2404 R2404IF R2404T2 R2404A R2404IFA R2404T2A R2404B R2404IFB R2404T2B R2404FC R2404IFFC R2404T2FC	4520-2025-000 R1500 R1500T2 R2004 R2004IF R2004T2 R1500A R1500T2A R2004A R2004IFA R2004T2A	4520-2025-001 R2404 R2404IF R2404T2 R2404A R2404IFA R2404T2A	4520-11010-000 R1500B R1500T2B R1500FC R1500T2FC	4520-11010-001 R2004B R2004IFB R2004T2B R2004FC R2004IFFC R2004T2FC R2404B R2404IFB R2404T2B R2404FC R2404IFFC R2404T2FC	

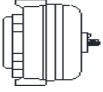
QFG-SERIES									
KNOB	GRILLE	BLOWER ASM				CLIP N FIT BOARD		THERMOSTAT	
									
3301-2040-001 G1512T2M G2024T2M G1512T2MA G2024T2MA G2224T2MA G1512T2MB G2024T2MB G2224T2MB G1512T2MC G2024T2MC G2224T2MC	2501-2046-000 ALL MODELS	1225-2000-000 G1012IF G1512IF G1512M G1512T2M G1512IFMA G1512MA G1512T2MA G1512IFMB G1512MB G1512T2MB G1512IFMC G1512T2MC	1225-2000-001 G1024IF G1524IF G2024IF G2024M G2024T2M G2028IF G2224IF G2024IFMA G2024MA G2024T2MA G2028IFA G2224IFMA G2224MA	1225-2002-001 G2224T2MA G2024IFMB G2024MB G2024T2MB G2028IFB G2024IFMC G2024T2MC	1225-2002-001 G2224IFMB G2224T2MB G2228IFB G2224IFC G2224T2MC G2228IFC	1249-2005-000 G1512M G1512T2M G2024M G2024T2M G2224M G1512MA G1512T2MA G2024IFMA G2024MA G2024T2MA G2224IFMA G2224MA G2224T2MA G1512IFMB		G1512MB G1512T2MB G2024IFMB G2024MB G2024T2MB G2224IFMB G2224T2MB G1512IFMC G1512T2MC G2024IFMC G2024T2MC G2224IFC G2224T2MC G2228IFC	410130001 G1512T2M G1512T2MA G1512T2MB G2024T2M G2024T2MA G2224T2MA G2024T2MB G2224T2MB G1512T2MC G2024T2MC G2224T2MC
ELEMENT		HI LIMIT				LIGHT			
									
1802-2124-005 G1024IF G2024IF	1802-2124-000 G1512IF G1512IFMA	4520-11012-000 G1512IFMC G1512T2MC	4520-11012-001 G2024IFMC G2024T2MC G2224IFC G2224T2MC	4520-2059-000 G1012IF G1512IF G1512M G1512T2M G1512IFMA G1512MA G1512T2MA G1512IFMB G1512MB G1512T2MB G1024IF G1524IF G2024M G2024T2M G2228IFB		3510-2017-000 G1012IF G1512IF G1512M G1512T2M G1512IFMA G1512MA G1512T2MA G1512IFMB G1512MB G1512T2MB G1512IFMC G1512T2MC	3510-2017-001 G1024IF G1524IF G2024IF G2024M G2024T2M G2028IF G2224IF G2224M G2024IFMA G2024MA G2024T2MA G2028IFA G2224IFC G2224MA	G2024IFMB G2024MB G2024T2MB G2028IFB G2224IFMB G2224T2MB G2228IFB G2024IFMC G2024T2MC G2224IFC G2224T2MC G2228IFC	
1802-2125-000 G1512IFMB G1512MB G1512T2MB G1512IFMC G1512T2MC	1802-2125-002 G2024IFMB G2024MB G2024T2MB G2024IFMC G2024T2MC	 Patented Clip-N-Fit® feature (US Patented No. 6,172,343)		G1512MA G1512T2MA G1512IFMB G1512MB G1512T2MB G1024IF G1524IF G2024M G2024T2M G2228IFB		G2024IFMA G2024MA G2028IFA G2224IFMA G2224MA G2024IFMC G2024T2MA G2028IFA G2224IFC G2224MA		G2024IFMB G2024MB G2024T2MB G2028IFB G2224IFMB G2224T2MB G2228IFB G2024IFMC G2024T2MC G2224IFC G2224T2MC G2228IFC	
1802-2124-001 G2028IFB	1802-2125-001 G2224IFMB			G1512MA G1512T2MA G1512IFMB G1512MB G1512T2MB G1024IF G1524IF G2024M G2024T2M G2228IFB		G2024IFMA G2024MA G2028IFA G2224IFMA G2224MA G2024IFMC G2024T2MA G2028IFA G2224IFC G2224MA		G2024IFMB G2024MB G2024T2MB G2028IFB G2224IFMB G2224T2MB G2228IFB G2024IFMC G2024T2MC G2224IFC G2224T2MC G2228IFC	
1802-2125-006 G2228IFB G2228IFC	G2224T2MB G2224IFC G2224T2MC			G1512MA G1512T2MA G1512IFMB G1512MB G1512T2MB G1024IF G1524IF G2024M G2024T2M G2228IFB		G2024IFMA G2024MA G2028IFA G2224IFMA G2224MA G2024IFMC G2024T2MA G2028IFA G2224IFC G2224MA		G2024IFMB G2024MB G2024T2MB G2028IFB G2224IFMB G2224T2MB G2228IFB G2024IFMC G2024T2MC G2224IFC G2224T2MC G2228IFC	
MODELS NOT LISTED ELEMENTS ARE OBSOLETE				G1512MA G1512T2MA G1512IFMB G1512MB G1512T2MB G1024IF G1524IF G2024M G2024T2M G2228IFB		G2024IFMA G2024MA G2028IFA G2224IFMA G2224MA G2024IFMC G2024T2MA G2028IFA G2224IFC G2224MA		G2024IFMB G2024MB G2024T2MB G2028IFB G2224IFMB G2224T2MB G2228IFB G2024IFMC G2024T2MC G2224IFC G2224T2MC G2228IFC	

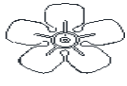

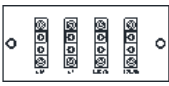
SED SERIES					
KNOB		GRILLE		LIGHT	
					
3301-2044-001 D1012C D1024C D1012CA D1024CA	3301-2039-002 D1012W D1512 D2024 D1012WA D1024WA D1512A D2024A	2501-2054-001 D1012C D1024C D1512CR D1012CA D1024CA D1512CRA	2501-2054-000 D1012W D1512 D2024 D1012WA D1024WA D1512A D2024A	3510-2017-002 D1012C D1012W D1512 D1512CR D1012CA D1012WA D1512A D1512CRA	3510-2017-003 D1024C D2024 D1024CA D1024WA D2024A
ELEMENT			FAN BLADE	MOTOR	
					
1802-2124-003 D1012C D1012W D1012CA D1012WA	1802-2124-005 D1024C D2024 D1024CA D1024WA D2024A	1802-2124-000 D1512 D1512CR D1512A D1512CRA	1210-2008-000 ALL MODELS	3900-2037-000 D1012C D1012W D1512 D1512CR D1012CA D1012WA D1512A D1512CRA	3900-2037-001 D1024C D2024 D1024CA D1024WA D2024A
THERMOSTAT		LIMIT			
					
410130001 D1012C D1012W D1512 D1012CA D1012WA D1512A D1024C D2024		4520-2055-000 D1012C D1012W D1512 D1512CR D1024C D2024	4520-11009-000 D1012CA D1012WA D1512A D1512CRA	4520-11009-001 D1024CA D1024WA D2024A	







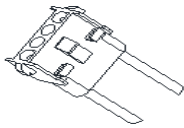
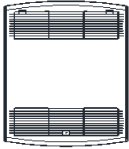
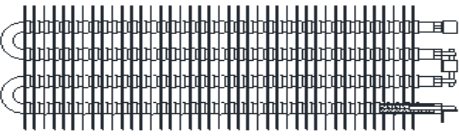
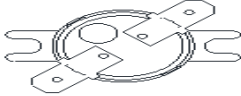

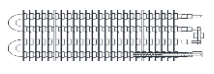

COZ-E WALL HEATER





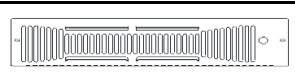
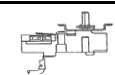

ELEMENT (INCLUDES LIMIT & ONE SHOT FUSE)		MOTOR		GRILLE
				
1802-11014-016 CZ1012IF	1802-11014-010 CZ1512T	3900-11032-000 CZ1012IF CZ1012T CZ1512IF CZ1512T	3900-11032-001 CZ1048IF CZ1048T CZ1548IF CZ1548T CZ2048IF CZ2048T	2501-11024-000 ALL MODELS
1802-11014-011 CZ1012T	1802-11014-018 CZ1548IF			
1802-11014-019 CZ1048IF	1802-11014-013 CZ1548T			
1802-11014-014 CZ1048T	1802-11014-017 CZ2048IF			
1802-11014-015 CZ1512IF	1802-11014-012 CZ2048T			
THERMOSTAT	FAN IMPELLER	PARTS KIT		
		PICTURE NOT AVAILABLE		
5813-2090-000 CZ1012T CZ1048T CZ1512T CZ1548T CZ2048T	2002-11004-000 ALL MODELS	1205-11028-501 CZ1012IF CZ1048IF CZ1512IF CZ1548IF CZ2048IF	1205-11028-500 CZ1012T CZ1048T CZ1512T CZ1548T CZ2048T	



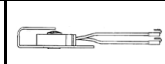

EFQ-SERIES						
GRILLE	ELEMENTS (2 REQ)			MOTOR (2 REQ)		
						
2501-2027-000 ALL MODELS	302012819 Q6003	302012821 Q8003	302012809 Q6004 Q8007	3900-2010-000 Q6003 Q6004 Q60048 Q6006 Q6008 Q8003 Q8004 Q80048 Q8006 Q8008	3900-2010-001 Q6007 Q8007	
	302012820 Q6006 Q8006	302012826 Q80048	302012806 Q6007			
	302012825 Q60048	302012808 Q6008 Q8004	302012807 Q8008			
THERMOSTAT	FAN BLADE (2 REQ)	DISCONNECT SW.	TERMINAL BOARD			
						
410168002 (2REQ.) Q6003 Q60048 Q6006 Q8003 Q80048 Q8006	5813-0023-000 Q6004 Q6007 Q6008 Q8004 Q8007 Q8008	490030103 ALL MODELS	5216-2025-000 ALL MODELS	5823-2002-000 ALL MODELS		
TRANSFORMER			FAN DELAY (2 REQ)	MANUAL LIMIT (2 REQ)		
						
490015017 Q6003 Q8003	490015022 Q60048 Q80048	490015013 Q6006 Q8006	410074000 ALL MODELS	4520-2027-000 ALL MODELS		

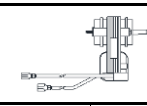
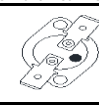













ECP SERIES (OBSOLETE)				
PLUG ASSY FEMALE	GRILLE	ELEMENT		LIMIT
				
1016-0114-000 ALL MODELS	2501-2082-000 ALL MODELS	302012808 ECP1024	302012803 ECP1524	4520-2025-001 ALL MODELS
				











QTS SERIES								
ELEMENTS		MOTOR ASSEMBLY		HI-LIMIT	SELF HOLD LIMIT	FAN DELAY		
								
302023811 S1100 S1100A S1100B S1100C S1100CNW	302023803 S1104 S1104A S1104B S1104C S1104CNW	1225-2002-000 S1100 S1100A S1100B S1100C S1100CNW	1225-2002-001 S1104 S1104A S1104B S1104C S1104CNW	4520-2031-000 S1100 S1100A S1100B S1104 S1104A S1104B S1500 S1500A S1500B S1500C S1500T S1500TA S1500TB S1500TC S1500TCNW	4520-11011-000 S1100C S1100CNW S1500C S1500TC S1500TCNW	1414-2020-000 S1100 S1100A S1104 S1104A S1500 S1500A S1500T S1500TA S1504 S1504A S1504T	410074000 S1100B S1100C S1100CNW S1104B S1104C S1104CNW S1500B S1500C S1500TB S1500TC S1500TCNW S1504B S1504C S1504TB S1504TCNW	
302023802 S1500 S1500A S1500B S1500C S1500T S1500TA S1500TB S1500TC S1500TCNW	302023806 S1504 S1504A S1504B S1504C S1504T S1504TA S1504TB S1504TC S1504TCNW	S1500 S1500A S1500B S1500C S1500T S1500TA S1500TB S1500TC S1500TCNW	S1504 S1504A S1504B S1504C S1504T S1504TA S1504TB S1504TC S1504TCNW	S1504 S1504A S1504B S1504C S1504T S1504TA S1504TB S1504TC S1504TCNW	4520-11011-001 S1104C S1104CNW S1504C S1504TC S1504TCNW	S1500A S1500T S1500TA S1504 S1504A S1504T	S1500B S1500C S1500TB S1500TC S1500TCNW S1504B S1504C S1504TB S1504TCNW	
PILOT LIGHT		GRILLE		THERMOSTAT	KNOB	THERMAL CUTOFF		
								
3510-2010-000 S1100A S1100B S1100C S1100CNW S1500A S1500B S1500C S1500TA S1500TB S1500TC S1500TCNW	3510-2010-001 S1104 S1104A S1104B S1104C S1104CNW S1504 S1504A S1504B S1504C S1504T S1504TA S1504TB S1504TC S1504TCNW	2501-2039-000 S1100 S1100A S1100B S1100C S1104 S1104A S1104B S1104C S1500 S1500A S1500B S1500C S1500TA S1500TB		S1500TC S1504 S1504A S1504B S1504C S1504T S1504TA S1504TB S1504TC	2501-2039-001 S1100CNW S1104CNW S1500CNW S1504CNW	410129001 S1500T S1500TA S1500TB S1500TC S1500TCNW S1504T S1504TA S1504TB S1504TC S1504TCNW	3301-2020-006 S1500T S1500TA S1500TB S1500TC S1500TCNW S1504T S1504TA S1504TB S1504TC S1504TCNW	4520-2030-000 ALL MODELS 









FDI SERIES				
BLADE	ELEMENT		GRILLE	BUZZER
				
1210-0046-000 I1500 I1504	1802-5032-000 I1500	1802-5032-004 I1504	2501-5016-001 I1500 I1504	2714-2001-001 I1500 I1504
MOTOR		ONE SHOT FUSE BLUE DOT	HI LIMIT WHITE DOT	
				
3900-2025-000 I1500	3900-2025-001 I1504	4520-2041-000 I1500 I1504	4520-5015-001 I1500 I1504	

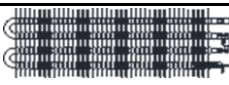
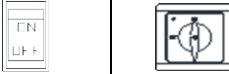

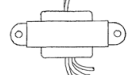





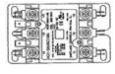

WHT SERIES PUMP HOUSE HEATER			
ELEMENT	KNOB	THERMOSTAT	
			
1802-2091-000	3301-2020-006	5813-2062-000	

CFWF					
TOP FRONT PANEL	BOTTOM FRONT PANEL	TOP TRIM PANEL	MOTOR	RELAY	TRANSFORMER
					
1402-2312-000 CFWF920 CFWF920A	1402-2313-000 CFWF920 CFWF920A	5806-2004-000 CFWF920 CFWF920A	3900-2036-000 CFWF920 CFWF920A	5018-2017-001 CFWF920 CFWF920A	5814-0003-000 CFWF920 CFWF920A
HI-LIMIT	MANUAL RESET LIMIT	ELEMENT	FAN BLADE	PILOT LIGHT	CERAMIC LIMITS
					
4520-2053-000 CFWF920	4520-2027-000 CFWF920A	1802-2117-101 CFWF920 CFWF920A	1210-2009-001 CFWF920 CFWF920A	3510-2018-000 CFWF920 CFWF920A	4520-2052-000 CFWF920 CFWF920A



QCH (U SERIES)						
GRILLE		PLASTIC COVER (2 REQ)	ELEMENTS		MOTOR	
						
1402-2121-000 U1000 U1000A U1500 U1500A U1507 U1800 U2004 U2004A U2007 U2007A U2008	1016-11228-001 U1000FA U1500FA U2004FA U2007FA	1402-2119-000 U1000 U1000A U1500 U1500A U1507 U1800 U2004 U2004A U2007 U2007A U2008	302023812 U1000 U1000A U1000FA	302023803 U1507 302023808 U1800	490062001 U1000 U1000A U1000FA U1500 U1500A U1800	490062003 U2004 U2004A U2004FA
			302023802 U1500 U1500A U1500FA	302023806 U2007 U2007A U2007FA		490062004 U2007 U2007A U2007FA
			302023805 U2004 U2004A U2004FA	302023804 U2008	490062004 U1507	490062002 U2008
LIGHT		FAND DELAY	HI-LIMIT	FAND BLADE	DISCONNECT SW	
						
3510-2008-003 U1000A U1000FA U1500A U1500FA	3510-2008-002 U2004A U2004FA U2007A U2007FA	410074000 ALL MODELS	410143000 ALL MODELS	490061001 ALL MODELS	410170001 ALL MODELS	

EFF (F SERIES)						
MOTOR		ELEMENT			DISCONNECT	
						
3900-2002-520 F1500	3900-2002-500 F2004 F2008 F3003 F3006 F4003 F4004 F4006 F4008	302012827 F1500	302012821 F4003	302012811 F4807	410170001 F1500 F1507 F2004 F2007 F2008 F3007 F4004 F4007 F4008 F4804 F4807	5216-2019-000 F3003 F3006 F4003 F40043 F4006 F40083 F4803 F48043 F4806 F4808 F48083 F48483 F48483LV
3900-2002-501 F1507 F2007 F3007 F4007 F4807	F3003 F3006 F4003 F4004 F4006 F4008	302015806 F1507	302012808 F4004	1802-2075-802 F40043		
3900-2002-518 F40043 F40083 F48043 F4808 F48083	F4006 F4008 F4803 F4804 F4806	302015802 F2004	302012822 F4006	1802-2075-800 F40083		
		302015803 F2007	302012809 F4007	1802-2075-803 F48043		
		302015801 F2008	302012807 F4008	1802-2075-801 F4808 F48083		
	3900-2002-021 F48483 F48483LV	302012819 F3003	302012823 F4803	1802-2075-804 F48483 F48483LV		
3900-2002-518 F40043 F40083 F48043 F4808 F48083		302012820 F3006	302012810 F4804			
		302012806 F3007	302012824 F4806			
POWER TR.	SECONDARY TR.	RELAY	GRILLE	HI-LIMIT	FAN DELAY	FAN BLADE
						
490015017 F3003 F4003 F4803	490065002 F48483LV	5018-2017-000 F40043 F48043 F48483	1402-2139-001 ALL MODELS	410169001 ALL MODELS	410074000 ALL MODELS	490030103 ALL MODELS
490015013 F3006 F4006 F4806		5018-2017-004 F40083 F4808 F48083				
490015022 F48483 F48483LV		5018-2017-001 F48483LV				

CDF (500 SERIES)						
ELEMENT	MOTOR	RELAY	OUTLET GRILLE(2 REQ'D)	LOUVER GUIDES NAV W.	LOUVER GUIDES NOR W.	
						
302012802 542	302012813 552	3900-2011-000 542	2501-2020-001 NAVAJO WHITE	1215-2059-000 REA (2 REQ'D)	1215-2059-002 REA (2 REQ'D)	
302012803 547	302012814 557	548			2501-2020-002 NORTHERN WHITE	1215-2059-003 SEA (2 REQ'D)
302012801 548	302012812 558	552				
		3900-2011-001 547 557				
		558				
		5018-0004-103 547 557				
FAN DELAY	FAN BLADE	HI-LIMIT	POWER BLOCK			
						
1414-2039-000 ALL MODELS	1210-2000-000 ALL MODELS	4520-0011-000 ALL MODELS	5823-0004-000 ALL MODELS			

CJ900 SERIES













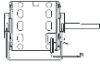
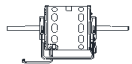















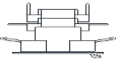
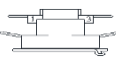
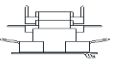
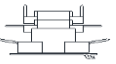
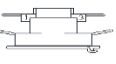
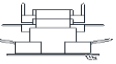

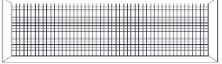
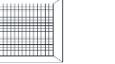





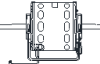

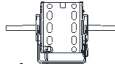

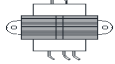

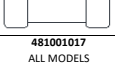
ELEMENTS

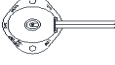
MODEL	NO. REQ.	208V	NO. REQ.	240V	NO. REQ.	277V	NO. REQ.	347V	NO. REQ.	380V	NO. REQ.	480V	NO. REQ.	600V
935														
2KW	1	1802-2083-100	1	1802-2083-101	1	1802-2083-114	1	1802-2083-103	1	1802-2083-101	1	1802-2083-114	1	1802-2083-103
3KW	1	1802-2083-107	1	1802-2083-108	1	1802-2083-116	1	1802-2083-105	1	1802-2083-108	1	1802-2083-116	1	1802-2083-105
4KW	1	1802-2083-106	1	1802-2083-107	1	1802-2083-108	1	1802-2083-109	1	1802-2083-107	1	1802-2083-118	1	1802-2083-109
5KW	1	1802-2083-110	1	1802-2083-111	1	1802-2083-120	1	1802-2083-113	1	1802-2083-111	1	1802-2083-120	1	1802-2083-113
6KW	2	1802-2083-107	2	1802-2083-108	2	1802-2083-116	2	1802-2083-105	2	1802-2083-108	2	1802-2083-116	2	1802-2083-105
7KW	1	1802-2083-106	1	1802-2083-107	1	1802-2083-116	1	1802-2083-109	1	1802-2083-107	1	1802-2083-116	1	1802-2083-109
	1	1802-2083-107	1	1802-2083-108	1	1802-2083-118	1	1802-2083-109	1	1802-2083-108	1	1802-2083-118	1	1802-2083-109
8KW	1	1802-2083-107	1	1802-2083-108	1	1802-2083-116	1	1802-2083-105	1	1802-2083-108	1	1802-2083-116	1	1802-2083-105
	1	1802-2083-110	1	1802-2083-111	1	1802-2083-120	1	1802-2083-113	1	1802-2083-111	1	1802-2083-120	1	1802-2083-113
945														
4KW	2	1802-2083-100	2	1802-2083-101	2	1802-2083-114	2	1802-2083-103	2	1802-2083-101	2	1802-2083-114	2	1802-2083-103
6KW	2	1802-2083-107	2	1802-2083-108	2	1802-2083-116	2	1802-2083-105	2	1802-2083-108	2	1802-2083-116	2	1802-2083-105
8KW	2	1802-2083-106	2	1802-2083-107	2	1802-2083-108	2	1802-2083-109	2	1802-2083-107	2	1802-2083-118	2	1802-2083-109
10KW	2	1802-2083-110	2	1802-2083-111	2	1802-2083-120	2	1802-2083-113	2	1802-2083-111	2	1802-2083-120	2	1802-2083-113
12KW	4	1802-2083-107	4	1802-2083-108	4	1802-2083-116	4	1802-2083-105	4	1802-2083-108	4	1802-2083-116	4	1802-2083-105
14KW	2	1802-2083-106	2	1802-2083-107	2	1802-2083-116	2	1802-2083-105	2	1802-2083-107	2	1802-2083-116	2	1802-2083-105
	2	1802-2083-107	2	1802-2083-108	2	1802-2083-118	2	1802-2083-109	2	1802-2083-108	2	1802-2083-118	2	1802-2083-109
16KW	2	1802-2083-107	2	1802-2083-108	2	1802-2083-116	2	1802-2083-105	2	1802-2083-108	2	1802-2083-116	2	1802-2083-105
	2	1802-2083-110	2	1802-2083-111	2	1802-2083-120	2	1802-2083-113	2	1802-2083-111	2	1802-2083-120	2	1802-2083-113
58" AND LARGER HEATERS CONTACT FACTORY WITH CFID# ON UNIT'S NAMEPLATE														

LOUVERED PANELS







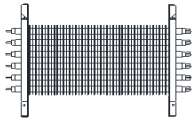
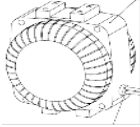

DESERT TAN	35"	4513-2114-T35	NAVAJO WHITE	35"	4513-2114-P35	NORTHERN WHITE	35"	4513-2114-W35	STAT BRONZE	35"	4513-2114-S35
	45"	4513-2114-T45		45"	4513-2114-P45		45"	4513-2114-W45		45"	4513-2114-S45
	58"	4513-2114-T58		58"	4513-2114-P58		58"	4513-2114-W58		58"	4513-2114-S58
	78"	4513-2114-T78		78"	4513-2114-P78		78"	4513-2114-W78		78"	4513-2114-S78
ALUMINUM	35"	4513-2114-A35	BLACK	35"	4513-2114-B35	CHARCOL GREY	35"	4513-2114-G35	NEUTRAL GREY	35"	4513-2114-N35
	45"	4513-2114-A45		45"	4513-2114-B45		45"	4513-2114-G45		45"	4513-2114-N45
	58"	4513-2114-A58		58"	4513-2114-B58		58"	4513-2114-G58		58"	4513-2114-N58
				78"	4513-2114-B78				78"	4513-2114-N78	

CU900 CONTINUED						
PRIMARY TRANSFORMER		SEC. TRANSFORMER		MOTORS		BLOWER WHEEL
						
CONTACT FACTORY WITH CFID# ON UNIT'S NAMEPLATE		490026910 MODELS WITH 24V CONTR.		CONTACT FACTORY WITH CFID# ON UNIT'S NAMEPLATE	CONTACT FACTORY WITH CFID# ON UNIT'S NAMEPLATE	490047001 ALL MODELS
DAMPER MOTOR	DAMPER RHEOSTAT	DAMPER RHEOSTAT KNOB	THERMOSTAT SPST	THERMOSTAT 2STG	THERMOSTAT KNOB	PLUG BUTTON
						
490050001 MODELS WITH AIR DAMPER	410104001 MODELS WITH AIR DAMPER	482084001 MODELS WITH AIR DAMPER	410127001 SINGLE STAGE MODELS	5813-2008-000 TWO STAGE MODELS	3301-2020-001 ALL MODELS	4506-2012-000 ALL MODELS
DAMPER ROCKER SW	FAN AUTO/ON SW	ON/OFF SW	HIGH/LOW SW	DOOR SAFETY SW	AUTO HIGH LIMIT	MANUAL LIMIT
						
410131001 MODELS WITH AIR DAMPER	5216-2029-001 ALL MODELS	5216-2029-001 ALL MODELS	5216-2029-000 SINGLE STAGE MODELS	5216-2028-000 ALL MODELS	4520-2048-000 ALL MODELS	4520-2017-000 ALL MODELS
FAN AUTO RELAY (120V)	FAN DELAY RELAY(120V)	POWER RELAY (120)	FAN AUTO RELAY (24V)	FAN DELAY RELAY (24V)	POWER RELAY (24)	NIGHT SETBACK RELAY
						
410101003 MODELS WITH 120V CONTROL	410171002 MODELS WITH 120V CONTROL	410101003 MODELS WITH 120V CONTROL	410101001 MODELS WITH 24V CONTROL	410171001 MODELS WITH 24V CONTROL	410101001 MODELS WITH 24V CONTROL	410101001 MODELS WITH N.S. RELAY
FUSE	FILTER	FILTER REUSABLE	DISCONNECT SW			
						
481001017 ALL MODELS	2010-7008-006 CU935	2010-7009-006 CU935	30 AMP	5216-2033-000	5216-2033-001	 <i>Optional model with architectural styled grille shown</i>
	2010-7008-007 CU945	2010-7009-007 CU945	60 AMP	5216-2033-001	5216-2033-002	
	2010-7008-008 CU958	2010-7009-008 CU958	100 AMP			
	2010-7008-009 CU968	2010-7009-009 CU968				
	2010-7008-010 CU978	2010-7009-010 CU978				

CU 900 SERIES STOCK MODELS						
ELEMENT		MOTOR				TIME DELAY RELAY
						
1802-2083-110 S93505203FFB S94510203FFB	1802-2083-120 S93505483FFB S94510483FFB	3900-2032-000 S93505203FFB S93505243FFB S93505483FFB S93505603FFB	3900-2033-000 S94510203FFB S94510243FFB S94510483FFB S94510603FFB	3900-2032-001 S93505271FFNC	3900-2033-001 S94510271FFNC	410101001 ALL MODELS
1802-2083-111 S93505243FFB S94510243FFB	S93505271FFNC S93505483FFNC S94510271FFNC			3900-2032-001 S93505483FFNC	3900-2033-002 S94510483FFNC	FAN DELAY RELAY
1802-2083-121 S93505603FFB S94510603FFB	S94510483FFNC					410171001 ALL MODELS
PRI. TRANSFORMER	CAPACITOR		FILTER			FUSE
						
490015025 S93505483FFB S94510483FFB	490015026 S93505603FFB S94510603FFB	1432-0002-003 S93505203FFB S93505243FFB S93505483FFB S93505603FFB S94510243FFB S94510483FFB S94510603FFB	1432-0002-001 S94510203FFB	2010-7008-006 S93505203FFB S93505243FFB S93505483FFB S93505603FFB	2010-7008-007 S94510203FFB S94510243FFB S94510483FFB S94510603FFB	481001017 ALL MODELS
490026002 S93505271FFNC S94510271FFNC	5814-0003-002 S93505483FFNC S94510483FFNC					PLUG BUTTON
4506-2012-000 ALL MODELS						BLOWER WHEEL
SEC. TR (240/24V)	MANUAL RESET	LIMIT	HIGH/LOW SW.	DOOR SW.	FAN AUTO/ON SW.	
						
490026910 ALL MODELS	4520-2017-000 ALL MODELS	4520-2048-000 ALL MODELS	5216-2029-000 ALL MODELS	5216-2028-000 ALL MODELS	5216-2029-001 ALL MODELS	490047001 ALL MODELS
THERMOSTAT	T'STAT KNOB					
						
410127001 ALL MODELS	3301-2020-001 ALL MODELS					



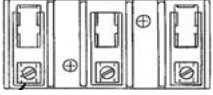



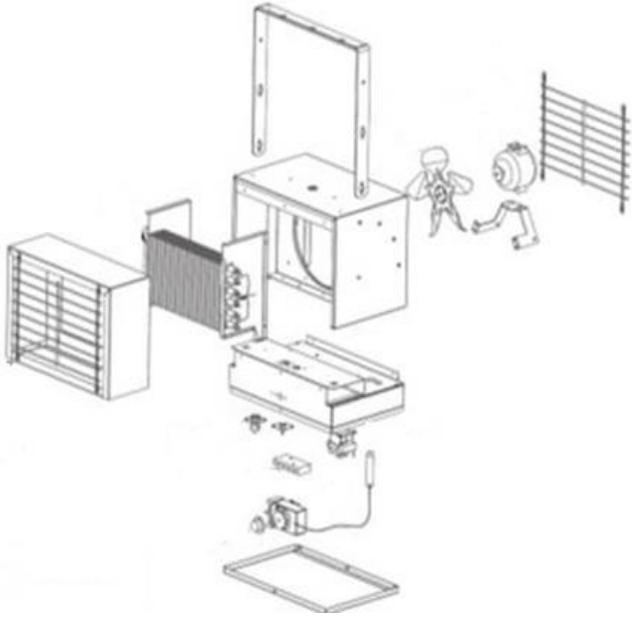





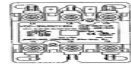





COMPACT FREEZE PROTECTION HEATERS PHFP25





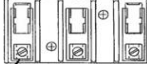
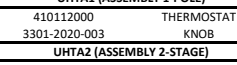





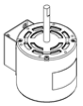
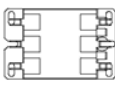
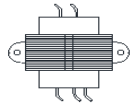

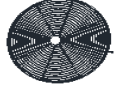

ELEMENT	MOTOR	FAN BLADE	FAN RELAY	RELAY
				
1802-11002-000 CHPR25	3900-11007-000 CHPR25	1210-2017-000 CHPR25	410171003 CHPR25	1414-2038-000 CHPR25
THERMOSTAT	KNOB	HI LIMIT	POWER BLOCK	MT. BRACKET
				
5813-2091-000 CHPR25	3301-2053-000 CHPR25	1414-2037-000 CHPR25	5823-0004-005 CHPR25	310876001 CHPR25

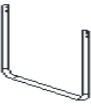
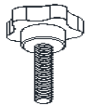

IUH SERIES

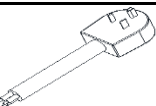
ELEMENT			FAN BLADE		MOTOR		RELAY			
										
302006804 UH520 UH520A	302006811 UH727 UH727A	302006842 UH1534 UH1560	1210-2017-000 UH520 UH520A UH524 UH524A	490011001 UH1020 UH1024 UH1027 UH1034 UH1048 UH1060 UH1520 UH1524 UH1527 UH1534 UH1548 UH1560A UH720 UH720A UH724 UH724A UH727 UH727A UH734 UH734A UH748 UH1060 UH2034 UH2060	3900-2008-000 UH520 UH520A UH524 UH534 UH534A UH538 UH538A UH548 UH548A UH560 UH720 UH720A UH724 UH724A UH748 UH748A	490059004 UH1020 UH1024 UH1027 UH1034 UH1048 UH1060 UH1520 UH1524 UH1527 UH1534 UH1548 UH1560 UH720 UH724 UH748 UH748A	5018-0004-102 UH520A UH524A UH538 UH538A UH548 UH548A UH560 UH720 UH724 UH748 UH748A UH760 UH760A UH1034	5018-0003-002 UH534 UH534A UH734 UH734A UH1534	5018-0005-006 UH1020 UH1024 UH1027 UH1048 UH1060 UH1520 UH1524 UH1527 UH1548 UH1560 UH2034 UH2048 UH2060 UH2548 UH2560 UH3048 UH3060	
302006807 UH524 UH524A UH548 UH548A	302006840 UH734 UH734A UH760 UH760A	302006829 UH2548 302006843 UH2560 302006822 UH3048 302006844 UH3060	UH534 UH534A UH538 UH538A UH548 UH548A UH560 UH720 UH720A UH724 UH724A UH727 UH727A UH734 UH734A UH748 UH1060 UH2034 UH2060	UH1020 UH1024 UH1027 UH1034 UH1048 UH1060 UH1520 UH1524 UH1527 UH1534 UH1548 UH1560 UH720 UH720A UH724 UH724A UH748 UH748A UH760 UH760A	UH520 UH520A UH524 UH534 UH534A UH538 UH538A UH548 UH548A UH560 UH720 UH720A UH724 UH724A UH748 UH748A	UH1020 UH1024 UH1027 UH1034 UH1048 UH1060 UH1520 UH1524 UH1527 UH1534 UH1548 UH1560 UH720 UH724 UH748 UH748A	UH520A UH524A UH538 UH538A UH548 UH548A UH560 UH720 UH724 UH748 UH748A UH760 UH760A UH1034	UH534 UH534A UH734 UH734A UH1534	UH1020 UH1024 UH1027 UH1048 UH1060 UH1520 UH1524 UH1527 UH1548 UH1560 UH2034 UH2048 UH2060 UH2548 UH2560 UH3048 UH3060	
302006839 UH534 UH534A UH560 UH560A	302006812 UH1020 UH1527 302006813 UH1024 UH1048 UH1520 UH2048	UH3048 UH3060	UH538 UH538A UH548 UH548A UH560 UH720 UH720A UH724 UH724A UH727 UH727A UH734 UH734A UH748 UH1060 UH2034 UH2060	UH1020 UH1024 UH1027 UH1034 UH1048 UH1060 UH1520 UH1524 UH1527 UH1534 UH1548 UH1560 UH720 UH720A UH724 UH724A UH748 UH748A UH760 UH760A	UH520 UH520A UH524 UH534 UH534A UH538 UH538A UH548 UH548A UH560 UH720 UH720A UH724 UH724A UH748 UH748A	UH1020 UH1024 UH1027 UH1034 UH1048 UH1060 UH1520 UH1524 UH1527 UH1534 UH1548 UH1560 UH720 UH724 UH748 UH748A	UH520A UH524A UH538 UH538A UH548 UH548A UH560 UH720 UH724 UH748 UH748A UH760 UH760A UH1034	UH534 UH534A UH734 UH734A UH1534	UH1020 UH1024 UH1027 UH1048 UH1060 UH1520 UH1524 UH1527 UH1548 UH1560 UH2034 UH2048 UH2060 UH2548 UH2560 UH3048 UH3060	
302006848 UH538 UH538A	UH1048 UH1520 UH2048		UH724 UH727 UH727A UH734 UH734A UH748 UH748A UH760 UH760A	UH1020 UH1024 UH1027 UH1034 UH1048 UH1060 UH1520 UH1524 UH1527 UH1534 UH1548 UH1560 UH720 UH720A UH724 UH724A UH748 UH748A UH760 UH760A	UH520 UH520A UH524 UH534 UH534A UH538 UH538A UH548 UH548A UH560 UH720 UH720A UH724 UH724A UH748 UH748A	UH1020 UH1024 UH1027 UH1034 UH1048 UH1060 UH1520 UH1524 UH1527 UH1534 UH1548 UH1560 UH720 UH724 UH748 UH748A	UH520A UH524A UH538 UH538A UH548 UH548A UH560 UH720 UH724 UH748 UH748A UH760 UH760A UH1034	UH534 UH534A UH734 UH734A UH1534	UH1020 UH1024 UH1027 UH1048 UH1060 UH1520 UH1524 UH1527 UH1548 UH1560 UH2034 UH2048 UH2060 UH2548 UH2560 UH3048 UH3060	
302006809 UH720 UH720A	302006814 UH1027 UH1524 UH1548		UH724 UH727 UH727A UH734 UH734A UH748 UH748A UH760 UH760A	UH1020 UH1024 UH1027 UH1034 UH1048 UH1060 UH1520 UH1524 UH1527 UH1534 UH1548 UH1560 UH720 UH720A UH724 UH724A UH748 UH748A UH760 UH760A	UH520 UH520A UH524 UH534 UH534A UH538 UH538A UH548 UH548A UH560 UH720 UH720A UH724 UH724A UH748 UH748A	UH1020 UH1024 UH1027 UH1034 UH1048 UH1060 UH1520 UH1524 UH1527 UH1534 UH1548 UH1560 UH720 UH724 UH748 UH748A	UH520A UH524A UH538 UH538A UH548 UH548A UH560 UH720 UH724 UH748 UH748A UH760 UH760A UH1034	UH534 UH534A UH734 UH734A UH1534	UH1020 UH1024 UH1027 UH1048 UH1060 UH1520 UH1524 UH1527 UH1548 UH1560 UH2034 UH2048 UH2060 UH2548 UH2560 UH3048 UH3060	
302006810 UH724 UH724A UH748 UH748A	302006841 UH1034 UH1060 UH2034 UH2060		UH724 UH727 UH727A UH734 UH734A UH748 UH748A UH760 UH760A	UH1020 UH1024 UH1027 UH1034 UH1048 UH1060 UH1520 UH1524 UH1527 UH1534 UH1548 UH1560 UH720 UH720A UH724 UH724A UH748 UH748A UH760 UH760A	UH520 UH520A UH524 UH534 UH534A UH538 UH538A UH548 UH548A UH560 UH720 UH720A UH724 UH724A UH748 UH748A	UH1020 UH1024 UH1027 UH1034 UH1048 UH1060 UH1520 UH1524 UH1527 UH1534 UH1548 UH1560 UH720 UH724 UH748 UH748A	UH520A UH524A UH538 UH538A UH548 UH548A UH560 UH720 UH724 UH748 UH748A UH760 UH760A UH1034	UH534 UH534A UH734 UH734A UH1534	UH1020 UH1024 UH1027 UH1048 UH1060 UH1520 UH1524 UH1527 UH1548 UH1560 UH2034 UH2048 UH2060 UH2548 UH2560 UH3048 UH3060	
LIGHT	FUSE BLOCK	FUSE	CAPACITOR	HI LIMIT	FAN DELAY	TRANSFORMER				
										
3510-2017-003 UH524A UH724A	480099002 UH1020 UH1024 UH1520 480099003 UH1520 UH1524 480096000 UH1527 480099001 UH1534 UH2034 2025-0001-000 UH2034	481001003 UH1020 UH1024 UH1520 UH1534 UH2034 481001006 UH1520 UH1524 481001023 UH1527 2019-7002-007 UH2034	1432-0002-003 UH2548 UH2560 UH3048 UH3060	410027000 ALL MODELS	410148000 ALL MODELS	490015017 UH534 UH534A UH734 UH734A 490015014 UH538 UH538A 490056001 UH548 UH548A UH748 UH748A	490015013 UH560 UH560A UH760 UH760A 490015009 UH1027 UH1527 490015019 UH1034 UH1534 UH2034	490015010 UH1048 UH1548 UH2048 490015012 UH1060 UH1560 UH2060 490015008 UH2548 UH3048 490015015 UH2560 UH3060		
QUANTITY 5 & 7.5KW (4) 10 THRU 20KW (6) 25 & 30KW (9)	LOUVER		LOUVER SPRING	HOLE PLUG	MT. BRACKET	POWER BLOCK		THERMOSTAT (ASSM INCLUDES KNOB)		
										
3503-2004-109 UH520 UH520A UH524 UH524A UH534 UH534A UH538 UH538A UH548 UH548A UH560 UH560A UH720 UH720A UH724 UH724A UH727 UH727A UH734 UH734A UH748 UH748A UH760 UH760A	3503-2004-111 UH1020 UH1024 UH1027 UH1034 UH1048 UH1060 UH1520 UH1524 UH1527 UH1534 UH1548 UH1560 UH2034 UH2048 UH2060	3503-2004-112 UH2548 UH2560 UH3048 UH3060	5208-7005-001 ALL MODELS	29214-11621 UH520 UH520A UH524 UH524A UH534 UH534A UH538 UH538A UH548 UH548A UH560 UH560A UH720 UH720A UH724 UH724A UH727 UH727A UH734 UH734A UH748 UH748A UH760 UH760A	310876001 UH520 UH520A UH524 UH524A UH534 UH534A UH538 UH538A UH548 UH548A UH560 UH560A UH720 UH720A UH724 UH724A UH727 UH727A UH734 UH734A UH748 UH748A UH760 UH760A	5823-0004-000 UH520 UH520A UH524 UH524A UH534 UH534A UH538 UH538A UH548 UH548A UH560 UH560A UH720 UH720A UH724 UH724A UH727 UH727A UH734 UH734A UH748 UH748A UH760 UH760A 5823-0004-005 UH734 UH734A	480100001 UH1020 UH1024 UH1027 UH1034 UH1048 UH1060 UH1520 UH1524 UH1527 UH1534 UH1548 UH1560 UH2034 UH2048 UH2060 480034002 UH2548 UH2560 UH3048 UH3060	410112000 THERMOSTAT 3301-2020-003 KNOB UH2A2 (ASSEMBLY 2-STAGE) 5813-2087-000 THERMOSTAT 3301-2053-000 KNOB		

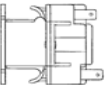
MEDH SERIES

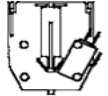
ELEMENT SMALL		ELEMENT LARGE		MOTOR		CONTACTOR		TRANSFORMER			
											
1802-11001-000 DH1583A DH1583B DH1583C		1802-11001-001 DH1583A DH1583B DH1583C		3900-11002-000 DH1021A DH1021CKA DH1021CKB DH1021CKC		5018-0006-000 DH1543A DH1543B DH1543C DH3043A DH3043B DH3043C		5018-0006-004 DH1021A DH1021CKA DH1021CKB DH1521A DH1521B DH1521C DH1523A DH1523B DH1523C DH1583A DH1583B DH1583C		5814-0003-002 DH1543A DH1543B DH1543C DH3043A DH3043B DH3043C	
1802-11001-002 DH1021A DH1021CKA DH1021CKB DH1021CKC DH1521A DH1521B DH1521C DH1523A DH1523B DH1523C DH1543A DH1543B DH1543C DH3043A DH3043B DH3043C		1802-11001-003 DH1021A DH1021CKA DH1021CKB DH1021CKC DH1521A DH1521B DH1521C DH1523A DH1523B DH1523C DH1543A DH1543B DH1543C DH3043A DH3043B DH3043C		3900-11002-001 DH1543A DH1543B DH1543C DH3043A DH3043B DH3043C		5018-0006-002 DH1021CKC					
FAN BLADE		HI LIMIT		THERMOSTAT		CAPACITOR		GUARD REAR		GUARD FRONT	
											
1210-0098-001 ALL MODELS		410029000 ALL MODELS		5813-2059-000 ALL MODELS		1432-0002-003 ALL MODELS		2504-11004-000 ALL MODELS		2504-11005-000 ALL MODELS	
HANDLE		CART KNOB		THERMOSTAT KNOB		WHEEL		SHAFT CAP		AXEL SHAFT	
											
2710-11001-000 ALL MODELS		3301-11003-000 ALL MODELS		3301-11018-002 ALL MODELS		6406-11001-000 ALL MODELS		1408-11002-000 ALL MODELS		5217-11001-000 ALL MODELS	
CORD		FUSE		FUSE BLOCK		FAN RELAY		FAN DELAY		AUXILIARY SWITCH	
											
1016-10593-000 DH1021CKA DH1021CKB SCS10063 DH1021CKC		2019-7008-077 DH1521A DH1521B DH1521C		480030007 DH1521A DH1521B DH1521C		5018-0007-000 DH1543A DH1543B DH1543C DH3043A DH3043B DH3043C		1414-2039-000 DH3043C		5216-10564-000 DH1521C DH1543A DH1543B DH1543C DH3043A DH3043B DH3043C	

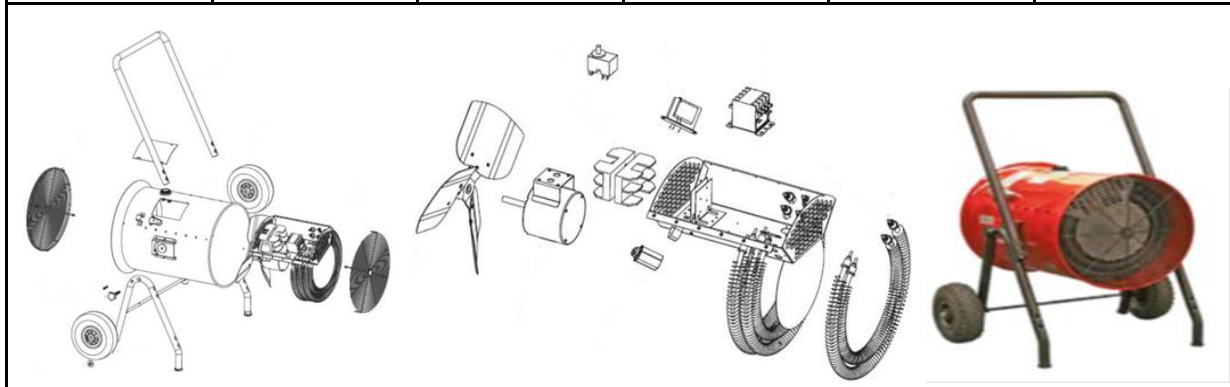

MSDH

MODEL	ELEMENT (11)	ELEMENT (12)	MOTOR (16)	CONTACTOR (20)
SDH3043	118-304793-011 (3)	118-304793-013 (3)	193-121843-232	072-304551-008
SDH3093	118-304793-012 (3)	118-304793-014 (3)	193-121843-233	072-304551-008
SDH4843	118-304793-011 (3)	118-304793-013 (6)	193-121843-232	072-304551-008 (2)
SDH4893	118-304793-012 (3)	118-304793-014 (6)	193-121843-233	072-304551-008 (2)
SDH6043	118-304793-011 (6)	118-304793-013 (6)	193-121843-232	072-304551-008 (2)
SDH6093	118-304793-012 (6)	118-304793-014 (6)	193-121843-233	072-304551-008 (2)
MODEL	TRANSFORMER (21)	FUSE BLOCK (80)	FUSE (81)	TERM. BLOCK (84)
SDH3043	315-304252-001	NA	NA	NA*
SDH3093	315-304252-003	NA	NA	NA*
SDH4843	315-304252-001	129-025643-001	128-026510-005 (3)	303-047468-004
SDH4893	315-304252-003	129-025643-001	128-026510-005 (3)	303-047468-004
SDH6043	315-304252-001	129-025643-001 (2)	128-026510-006 (6)	303-047468-004
SDH6093	315-304252-003	129-025643-001 (2)	128-026510-006 (6)	303-047468-004

PARTS COMMON TO ALL UNITS

TEMPERATURE CONTROL (18)	300-019560-002
HI-LIMIT (19)	300-049200-004
TOGGLE SWITCH (23)	292-046123-001
BLOWER ASSEMBLY (32)	021-304823-009
INLET & OUTLET GRILLE (33)	134-304780-002 (2)
CASTER/LOCKING (36)	375-122535-007
HANDLE-RIGHT SIDE (37)	139-304779-003
HANDLE-LEFT SIDE (38)	139-304479-004
SEMPNEUMATIC WHEEL (45)	333-557518-004 (2)
PULLEY VAR. PITCH 7/8" (77)	225-305091-004
PULLEY VAR. PITCH 5/8" (78)	225-305091-003
PULLEY BELT (79)	017-049702-009
PILOT LIGHT-GREEN (86)	213-122066-043
PILOT LIGHT-AMBER (87)	213-122066-042
THERMOSTAT KNOB (94)	169-017949-004

NOTES:

(#) QUANTITY REQ.



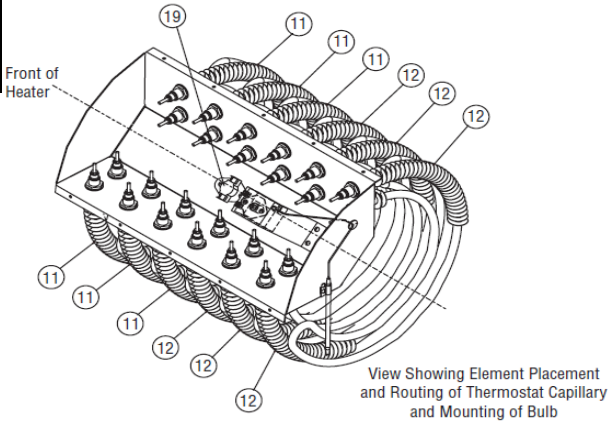
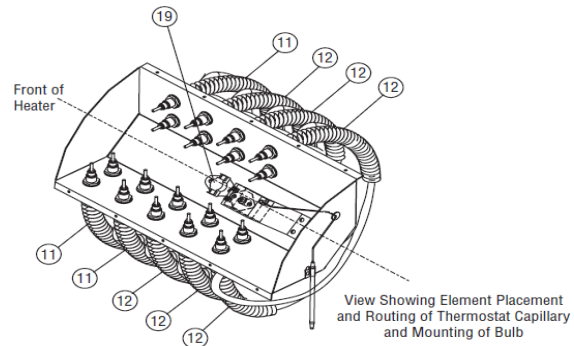
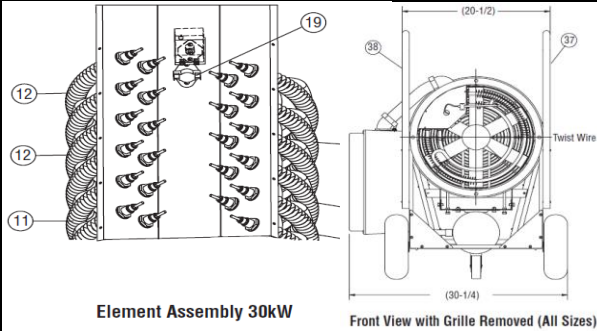



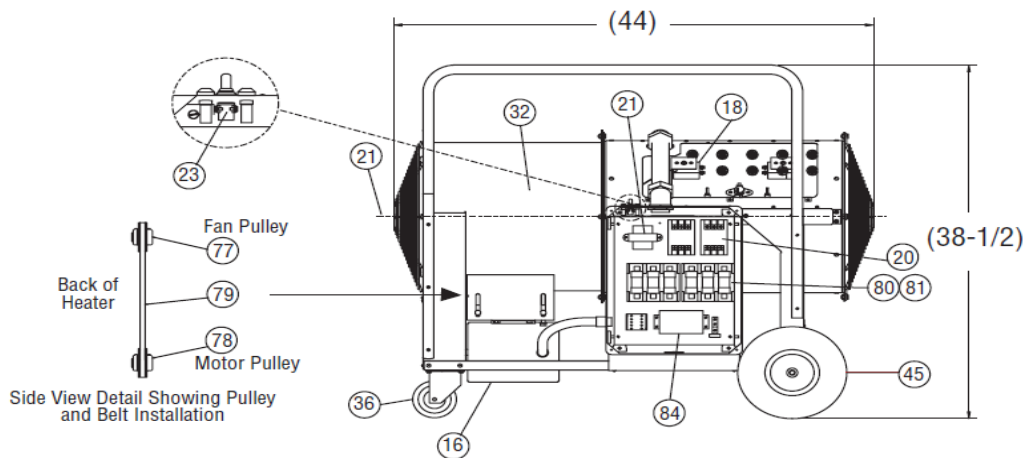

* WIRED DIRECTLY TO CONTACTOR

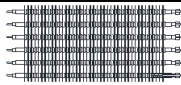
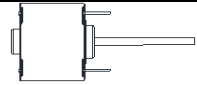
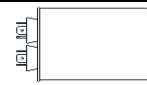



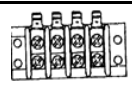
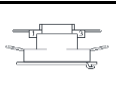
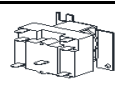

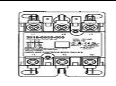

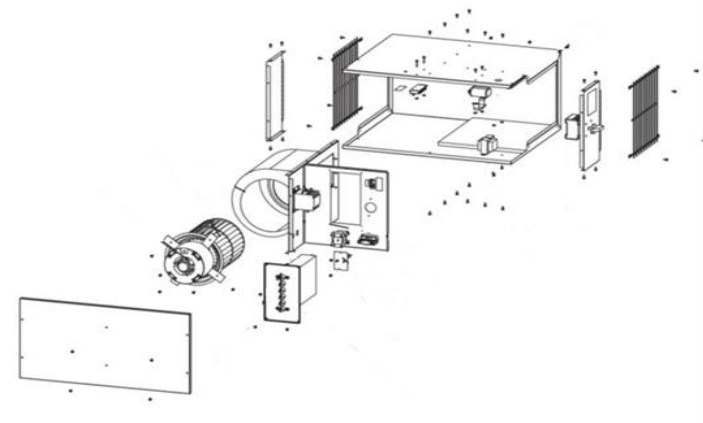

Element Assembly 48kW

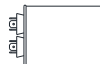
Element Assembly 60kW







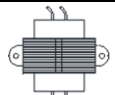
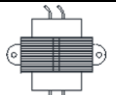

MSPH PLENUM RATED UNIT HEATER									
ELEMENT			MOTOR			CAPACITOR			
									
1802-10498-000 PRH1381240000 PRH1383240000	1802-10498-004 PRH11021240000 PRH11023240000	1802-10498-007 PRH1343240000 1802-10498-008 PRH11583240000 PRH17581240000 PRH17583240000	3900-10164-001 PRH11043240000 PRH11543240000 PRH1343240000 PRH1543240000 PRH17583240000	3900-10160-003 PRH11021240000 PRH11023240000 PRH1083240000 PRH11523240000 PRH1583240000 PRH1521240000 PRH1523240000 PRH1581240000 PRH158240000 PRH1583240000	3900-2094-001 PRH1321240000 PRH1323240000 PRH1381240000 PRH1383240000 PRH1521240000 PRH1523240000 PRH1581240000 PRH158240000 PRH1583240000	1432-0002-001 PRH11043240000 PRH1071240000 PRH11543240000 PRH1321240000 PRH1323240000 PRH1343240000 PRH1371240000 PRH1381240000 PRH1383240000 PRH1521240000 PRH1523240000		1432-0002-002 PRH1543240000 PRH1571240000 PRH1581240000 PRH158240000 PRH1583240000 PRH1521240000 PRH1523240000 PRH1581240000 PRH158240000 PRH1583240000 PRH17521240000 PRH17523240000 PRH17581240000 PRH1758240000 PRH17583240000 PRH21021240000 PRH21023240000 PRH1543240000 PRH1543240000 PRH21043240000	
1802-10498-001 PRH1321240000 PRH1323240000	1802-10498-002 PRH1523240000 PRH1721021240000 PRH21023240000	1802-10498-003 PRH11083240000 PRH1581240000 PRH158240000 PRH1583240000 PRH1583240000 PRH21083240000	1802-10498-005 PRH11071240000 PRH1571240000 PRH1571240000 PRH21071240000	1802-10498-006 PRH11043240000 PRH1543240000 PRH1543240000 PRH21043240000	1802-10498-009 PRH17521240000 PRH17523240000 PRH17523240000	1802-10498-010 PRH1571240000 PRH17571240000	1802-10498-011 PRH11543240000 PRH17543240000 PRH21543240000	3900-10162-001 PRH11071240000 PRH1571240000 PRH17571240000 PRH21071240000	3900-2095-001 PRH17521240000 PRH17523240000 PRH17581240000 PRH17583240000 PRH21021240000 PRH21023240000 PRH21083240000 PRH21523240000
BLOWER ASSEMBLY			LIMIT			GRILLE			
									
1225-10158-000 PRH11021240000 PRH11023240000 PRH11043240000 PRH1071240000 PRH11083240000 PRH11523240000 PRH11543240000 PRH11583240000 PRH1521240000 PRH1523240000 PRH153240000 PRH1571240000 PRH1581240000 PRH1583240000		1225-2022-000 PRH1321240000 PRH1323240000 PRH1343240000 PRH17571240000 PRH1381240000 PRH1383240000 PRH1521240000 PRH1523240000 PRH1543240000 PRH1571240000 PRH1581240000 PRH1583240000	1414-2040-001 PRH11021240000 PRH11023240000 PRH11043240000 PRH1071240000 PRH11083240000 PRH11523240000 PRH11543240000 PRH11583240000 PRH1521240000 PRH1523240000 PRH21071240000 PRH21083240000 PRH1571240000 PRH1581240000 PRH1583240000		1414-2040-000 PRH1321240000 PRH1323240000 PRH1343240000 PRH1371240000 PRH1381240000 PRH1383240000 PRH1521240000 PRH1523240000 PRH1543240000 PRH1571240000 PRH1581240000 PRH1583240000	2501-10156-800 PRH11021240000 PRH11023240000 PRH11043240000 PRH1071240000 PRH11083240000 PRH11523240000 PRH11543240000 PRH11583240000 PRH1521240000 PRH1523240000 PRH21043240000 PRH21071240000 PRH21083240000 PRH21523240000 PRH1581240000 PRH1583240000		312056803 PRH1321240000 PRH1323240000 PRH1343240000 PRH1371240000 PRH1381240000 PRH1383240000 PRH1521240000 PRH1523240000 PRH1543240000 PRH1571240000 PRH1581240000 PRH1583240000	
TRANSFORMER			TERMINAL BLOCK			TIME DELAY RELAY	FAN RELAY	DISCONNECT SW.	
									
5814-0003-000 PRH11021240000 PRH11023240000 PRH11083240000 PRH11523240000 PRH11583240000 PRH1321240000 PRH1323240000 PRH1381240000 PRH1383240000 PRH1521240000 PRH1523240000 PRH153240000		5814-0003-001 PRH11071240000 PRH1571240000 PRH1571240000 PRH17571240000 PRH21071240000 5814-0003-002 PRH11043240000 PRH11543240000 PRH1343240000 PRH1543240000 PRH1543240000 PRH17543240000 PRH21043240000 PRH21543240000	480106001 PRH11021240000 PRH11023240000 PRH11043240000 PRH1071240000 PRH11083240000 PRH11523240000 PRH11543240000 PRH11583240000 PRH1321240000 PRH1323240000 PRH1343240000 PRH1371240000 PRH1381240000 PRH1383240000 PRH1521240000 PRH1523240000		480106002 PRH1523240000 PRH1523240000 PRH1543240000 PRH1571240000 PRH1571240000 PRH1581240000 PRH1581240000 PRH158240000 PRH1583240000 PRH17521240000 PRH17523240000 PRH17543240000 PRH17571240000 PRH17581240000 PRH1758240000 PRH17583240000	410171001 ALL MODELS CONTACTOR RELAY  5018-0005-004 ALL MODELS 	5018-2024-000 ALL MODELS	5216-2036-000 ALL MODELS	
									



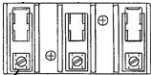







MUH SERIES



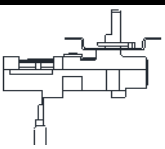
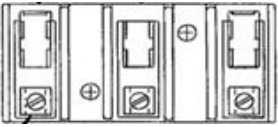
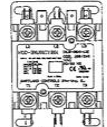

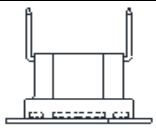

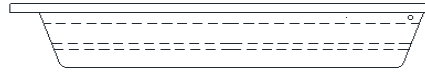



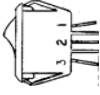

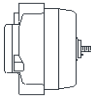

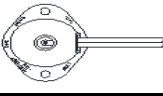
ELEMENT				MOTOR			CAPACITOR
QUANTITY OF ELEMENTS 3 THRU 10KW (3) 15 THRU 30KW (6) 40 & 50KW (9)							
1802-0087-000 MUH0321	1802-0087-004 MUH0571	1802-0087-011 MUH104	1802-0087-046 MUH256	3900-2002-506 MUH0321	3900-2014-004 MUH072	3900-0364-000 MUH252	1432-0002-003 MUH202
1802-0087-040 MUH0331	1802-0087-034 MUH0581	1802-0087-010 MUH107	1802-0087-018 MUH302	MUH0381	MUH073	MUH256	MUH204
1802-0087-002 MUH0341	1802-0087-025 MUH0581MG	1802-0087-036 MUH108	1802-0087-019 MUH304	MUH0521	MUH076	MUH302	MUH206
1802-2073-000 MUH0361	1802-0087-006 MUH072	1802-0087-012 MUH152	1802-0087-047 MUH306	MUH0521MG	MUH077	MUH306	MUH208
1802-0087-001 MUH0371	1802-0087-042 MUH073	1802-0087-008 MUH154	1802-0087-028 MUH308	MUH0581	MUH078	MUH308	MUH252
1802-0087-024 MUH0381	1802-0087-008 MUH074	1802-2073-002 MUH156	1802-0087-020 MUH402	MUH0581MG	MUH102	3900-0363-500 MUH254	MUH254
1802-0087-035 MUH0521	1802-2073-002 MUH076	1802-0087-037 MUH158	1802-0087-021 MUH404	3900-2002-516 MUH0331	MUH103	MUH304	1432-0002-001 MUH254A
1802-0087-003 MUH0521MG	1802-0087-007 MUH077	MUH202	1802-0087-048 MUH406	MUH0361	MUH106	3900-2065-000 MUH254A	MUH304A
1802-0087-041 MUH0531	1802-0087-031 MUH078	1802-0087-026 MUH208	1802-0087-022 MUH502	MUH0531	MUH107	MUH304A	MUH308
1802-0087-005 MUH0541	MUH102	1802-0087-016 MUH252	1802-0087-023 MUH504	MUH0561	MUH108	MUH304A	1432-0002-004 MUH402
1802-2073-001 MUH0561	1802-0087-044 MUH103	1802-0087-017 MUH254	1802-0087-049 MUH506	3900-2005-000 MUH0341	3900-0361-501 MUH154	3900-0350-000 MUH402	MUH404
	MUH106	MUH254A	1802-0087-030 MUH508	MUH0541	3900-0361-003 MUH156	MUH502	MUH406
	MUH206			3900-2002-507 MUH0371	3900-0362-000 MUH202	MUH506	MUH502
				MUH0571	MUH206	3900-0350-001 MUH404	MUH504
				3900-0347-005 MUH074	3900-0362-001 MUH204	MUH406	MUH506
				MUH104	3900-0362-002 MUH208	3900-0350-002 MUH508	
				3900-0361-500 MUH152			
				MUH158			
PROTECTOR LIMIT				FAN DELAY	FAN BLADE		HI/LOW SP. SWITCH
							
4520-0011-000 MUH0321	4520-0011-001 MUH072	4520-0011-002 MUH252	4520-0010-000 ALL MODELS	1210-2000-000 MUH0321	1210-0090-000 MUH072	1210-0098-000 MUH252	5216-2053-000 MUH252
MUH0331	MUH073	MUH254		MUH0331	MUH073	MUH254	MUH254
MUH0341	MUH074	MUH254A		MUH0341	MUH074	MUH254A	MUH254A
MUH0361	MUH076	MUH256		MUH0361	MUH076	MUH256	MUH256
MUH0371	MUH077	MUH302		MUH0371	MUH077	MUH302	MUH302
MUH0381	MUH078	MUH304		MUH0381	MUH078	MUH304	MUH304
MUH0521	MUH102	MUH304A		MUH0521	MUH102	MUH304A	MUH304A
MUH0521MG	MUH103	MUH306		MUH0521MG	MUH103	MUH306	MUH306
MUH0531	MUH104	MUH308		MUH0531	MUH104	MUH308	MUH308
MUH0541	MUH106	MUH402		MUH0541	MUH106	MUH402	MUH402
MUH0561	MUH107	MUH404		MUH0561	MUH107	1210-11004-000 MUH404	MUH404
MUH0571	MUH108	MUH406		MUH0571	MUH108	MUH406	MUH406
MUH0581	MUH152	MUH502		MUH0581	1210-0090-001 MUH152	MUH406	MUH502
MUH0581MG	MUH154	MUH504		MUH0581MG	MUH154	MUH502	MUH504
	MUH156	MUH506			MUH156	MUH506	MUH506
	MUH158	MUH508			MUH158	MUH508	MUH508
	MUH202				1210-0096-000 MUH202		
	MUH204				MUH204		
	MUH206				MUH206		
	MUH208				MUH208		
RELAY				POWER TR			SECONDARY TR
							
5018-0003-000 MUH0331	5018-0004-100 MUH0341	5018-0005-004 MUH152	5018-0006-000 MUH202	5814-0003-000 MUH072	5814-0003-002 MUH0341	490015017 MUH0331	5814-0003-000 MUH0331
MUH0531	MUH0361	MUH158	MUH308	MUH078	MUH0541	MUH0531	MUH0361
MUH072	MUH0541	MUH208	MUH504	MUH102	MUH074	490015018 MUH073	MUH0531
MUH073	MUH0561	MUH252	MUH508	MUH108	MUH104	MUH103	MUH0561
MUH077	MUH074	MUH254		MUH152	MUH154	MUH106	MUH073
MUH078	MUH076	MUH254A		MUH158	MUH204	490015021 MUH076	MUH076
MUH102	MUH104	MUH302		MUH202	MUH254	MUH106	MUH103
MUH103	MUH106	MUH304		MUH208	MUH254A	490026007 MUH402	MUH206
MUH107	MUH108	MUH304A		MUH252	MUH304	MUH402	MUH256
5018-0003-002 MUH0521MG	MUH154	MUH402		MUH302	MUH304A	MUH502	MUH306
MUH0581MG	MUH156	MUH404		MUH308	MUH404	MUH502	MUH406
	MUH204	MUH406		5814-0003-001 MUH077	MUH504	MUH508	MUH506
	MUH206	MUH502		MUH107	490015013 MUH0361		5814-2009-000 MUH106
	MUH256	MUH506		490015012 MUH156	MUH0561		MUH156
	MUH306			MUH158	490015015 MUH406		
	MUH404			MUH206	MUH506		
	MUH406			MUH256			
	MUH504			MUH306			
	MUH506						

MUH CONTINUED

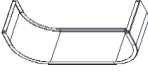
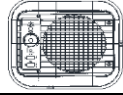





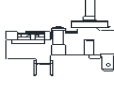
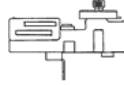



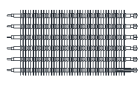

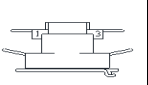
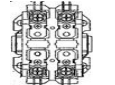
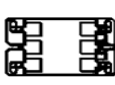
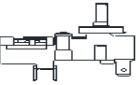
CONTROL BOARD			POWER BLOCK				
							
5823-0001-000 MUH0321 MUH0371 MUH0381 MUH0521 MUH0571 MUH0581	5823-0002-000 MUH0331 MUH0341 MUH0361 MUH0521MG MUH0531 MUH0541 MUH0561 MUH0581MG MUH072 MUH073 MUH074 MUH076 MUH077 MUH078 MUH102 MUH103 MUH104 MUH106 MUH107 MUH108 MUH152 MUH154 MUH156 MUH158	5823-0004-000 MUH0321 MUH0331 MUH0341 MUH0361 MUH0371 MUH0381 MUH0521 MUH0521MG MUH0531 MUH0541 MUH0561 MUH0571 MUH0581 MUH0581MG MUH072 MUH073	MUH074 MUH076 MUH077 MUH078 MUH102 MUH103 MUH104 MUH106 MUH107 MUH108 MUH154 MUH156 MUH204 MUH206 MUH256 MUH306	5823-0004-001 MUH152 MUH254 MUH254A MUH304 MUH304A	5823-0004-002 MUH202 MUH208 MUH252 MUH404 MUH406 MUH504 MUH506	5823-0004-003 MUH158 MUH302	5823-0005-000 MUH308 MUH402 MUH502 MUH508
LOUVERS QUANTITY 3&5KW (5) 7 THRU 20KW (6) 25 THRU 50KW (9)			LOUVER SPRING 	FUSE BLOCK 	FUSE 	THERMOSTAT (ASSM INCLUDES KNOB) UHMT1 (ASSEMBLY 1-POLE) 5813-0036-000 THERMOSTAT 3301-2020-006 KNOB UHMT2 (ASSEMBLY 2-STAGE) 5813-0037-000 THERMOSTAT 3301-2020-006 KNOB	
3503-2004-106 MUH0321 MUH0331 MUH0341 MUH0361 MUH0371 MUH0381 MUH0521 MUH0521MG MUH0531 MUH0541 MUH0561 MUH0571 MUH0581 MUH0581MG	3503-2004-101 MUH072 MUH073 MUH074 MUH076 MUH077 MUH078 MUH102 MUH103 MUH104 MUH106 MUH107 MUH108 MUH152 MUH154 MUH156 MUH158 MUH202 MUH204 MUH206 MUH208	3503-2004-108 MUH252 MUH254 MUH254A MUH256 MUH302 MUH304 MUH304A MUH306 MUH308 MUH402 MUH404 MUH406 MUH502 MUH504 MUH506 MUH508	5208-7005-001 ALL MODELS	2025-0002-000 MUH158 MUH208 480030004 MUH252 MUH302 MUH308 MUH402 MUH502 MUH508 2025-0001-000 MUH504 MUH506 2025-7004-000 MUH504 MUH506	2019-0007-010 MUH158 2019-0007-008 MUH208 2019-7008-077 MUH252 2019-7008-079 MUH302 MUH502 2019-7008-080 MUH308 MUH508 2019-7008-078 MUH402 2019-7002-008 MUH504 2019-7002-007 MUH506 2019-7002-012 MUH504 2019-7002-011 MUH506		

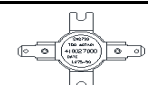
MWUH SERIES

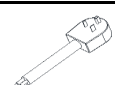
ELEMENT		MOTOR	FAN BLADE	KNOB	THERMOSTAT
					
302006807 MWUH5004 MWUH5004A 302006810 UH724ST UH724STA	302006847 MWUH5008 MWUH5008A	3900-2008-000 MWUH5004 MWUH5004A MWUH5008 MWUH5008A UH724ST UH724STA	1210-2017-000 MWUH5004 MWUH5004A MWUH5008 MWUH5008A UH724ST UH724STA	3301-2014-006 MWUH5004 MWUH5004A MWUH5008 MWUH5008A UH724ST UH724STA	5813-2050-000 MWUH5004 MWUH5004A MWUH5008 MWUH5008A UH724ST UH724STA
POWER BLOCK		RELAY	HI LIMIT	FAN DELAY	LIGHT
					
5823-0004-005 MWUH5004 MWUH5004A MWUH5008 MWUH5008A	5823-0004-000 UH724ST UH724STA	5018-0004-102 UH724ST UH724STA	410027000 MWUH5004 MWUH5004A MWUH5008 MWUH5008A UH724ST UH724STA	410148000 MWUH5004 MWUH5004A MWUH5008 MWUH5008A UH724ST UH724STA	3510-2017-003 MWUH5004A UH724STA
LOUVERS		LOUVER SPRING	MT. BRACKET		
					
3503-2004-009 MWUH5004 MWUH5004A MWUH5008 MWUH5008A	3503-2004-010 UH724ST UH724STA	5208-7005-001 MWUH5004 MWUH5004A MWUH5008 MWUH5008A UH724ST UH724STA	310876001 MWUH5004 MWUH5004A MWUH5008 MWUH5008A UH724ST UH724STA		

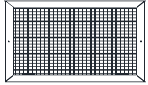

QPH4A & MUH35 SERIES					
ROCKER SWITCH**	FAN BLADE		ELEMENT***		MOTOR
					
S99814893A000 MUH35 MUH35B MUH35C MUH35D PH4A PH4AB NPH4AB NPH4ABA	1210-2000-000 MUH35 MUH35B MUH35C MUH35D PH4 PH4A	1210-2000-001 PH4AB NPH4AB NPH4ABA	1802-0087-032 MUH35 MUH35B MUH35C MUH35D	1802-0087-038 PH4 PH4A PH4AB NPH4AB NPH4ABA	3900-2002-506 MUH35 MUH35B MUH35C MUH35D PH4 PH4A PH4AB NPH4AB NPH4ABA
FAN DELAY	MANUAL RESET			LIMIT	BUZZER
					
4520-0010-000 MUH35C MUH35D	4520-2017-000 MUH35B MUH35C PH4A	4520-11004-000 PH4AB NPH4AB	4520-11004-002 MUH35D NPH4ABA	4520-0011-000 MUH35 PH4	2714-11001-000 MUH35D
STAND	CONTROL COVER	GRILLE	GUARD	T'STAT KNOB	STAND KNOB**
					
5210-2000-002 MUH35B MUH35C MUH35D PH4A PH4AB NPH4AB NPH4ABA	1402-0336-000 MUH35 MUH35B MUH35C MUH35D PH4 PH4AB NPH4AB NPH4ABA	1402-2154-001 MUH35B MUH35C MUH35D PH4AB NPH4AB NPH4ABA	2504-0011-001 MUH35B MUH35C MUH35D PH4 PH4AB NPH4AB NPH4ABA	3301-2012-001 MUH35B MUH35C MUH35D PH4AB NPH4AB NPH4ABA	3301-2018-000 MUH35 MUH35B MUH35C MUH35D PH4AB NPH4AB NPH4ABA
LIGHT	CORD	THERMOSTAT			
					
3510-2007-000 MUH35B MUH35C MUH35D	1420-2028-000 PH4AB 1420-11012-000 NPH4AB NPH4ABA	5813-2018-000 MUH35 MUH35B MUH35C MUH35D PH4A PH4AB NPH4AB NPH4ABA	5813-0047-000 PH4		
NOTE * INDICATES QUANTITY					



TBX SERIES (OBS)

ELEMENT	MOTOR	TIME DELAY RELAY	CONTACTOR 30AMP	CONTACTOR 50AMP	THERMOSTAT
					
302006814 TBX754	490059004 ALL MODELS	410171003 ALL MODELS	5018-0003-002 ALL MODELS	5018-0006-002 ALL MODELS	5813-2059-000 ALL MODELS
302006813 TBX104					
					
490011001 ALL MODELS	410169001 ALL MODELS	480100001 ALL MODELS	1016-0193-800 ALL MODELS	1016-10593-000 ALL MODELS	3301-2053-000 ALL MODELS
					
1017-0004-000 ALL MODELS	2501-10513-800 ALL MODELS	2710-10586-000 ALL MODELS	2710-2012-800 ALL MODELS	6406-0002-000 ALL MODELS	1408-10584-000 ALL MODELS



QWD WASHDOWN CONTINUED

CAPACITOR				STRAIGHT FITTING	SILICONE SEAL	TERMINAL BLOCK
					PICTURE NOT AVAILABLE	
1432-0002-001		1432-0002-003		1432-0002-004		1213-2009-000 ALL MODELS
WD02112A	WD05832A	WD03712A	WD12212A	WD20432A	WD20432A	5823-2006-000 ALL MODELS
WD02212A	WD07212A	WD05712A	WD12232A	WD20632A	WD20632A	
WD02812A	WD07232A	WD07712A	WD12432A	WD25232A	WD25232A	
WD03112A	WD07412A	WD10712A	WD12632A	WD25432A	WD25432A	
WD03212A	WD07432A		WD12812A	WD25632A	WD25632A	
WD03232A	WD07632A		WD12832A	WD25832A	WD25832A	
WD03432A	WD07812A		WD15212A	WD30232A	WD30232A	
WD03812A	WD07831A		WD15232A	WD30431A	WD30431A	
WD03832A	WD07832A		WD15412A	WD30432A	WD30432A	
WD05212A	WD10212A		WD15432A	WD30631A	WD30631A	
WD05232A	WD10232A		WD15632A	WD30632A	WD30632A	
WD05412A	WD10412A		WD15812A	WD30832A	WD30832A	
WD05431A	WD10432A		WD15832A	WD39432A	WD39432A	
WD05432A	WD10632A		WD20232A	WD394632A	WD394632A	
WD05632A	WD10832A		WD20412A			
WD05812A						

GRILLE INLET				GRILLE OUTLET			
							

2504-11018-000		2504-11020-000		2504-11019-001		2504-11021-001	
WD02112A	WD05832A	WD12212A	WD20432A	WD02112A	WD05832A	WD12212A	WD20432A
WD02212A	WD07212A	WD12232A	WD20632A	WD02212A	WD07212A	WD12232A	WD20632A
WD02812A	WD07232A	WD12432A	WD25232A	WD02812A	WD07232A	WD12432A	WD25232A
WD03112A	WD07412A	WD12632A	WD25432A	WD03112A	WD07412A	WD12632A	WD25432A
WD03212A	WD07432A	WD12812A	WD25632A	WD03212A	WD07432A	WD12812A	WD25632A
WD03232A	WD07632A	WD12832A	WD25832A	WD03232A	WD07632A	WD12832A	WD25832A
WD03432A	WD07712A	WD15212A	WD30232A	WD03432A	WD07712A	WD15212A	WD30232A
WD03712A	WD07812A	WD15232A	WD30431A	WD03712A	WD07812A	WD15232A	WD30431A
WD03812A	WD07831A	WD15412A	WD30432A	WD03812A	WD07831A	WD15412A	WD30432A
WD03832A	WD07832A	WD15432A	WD30631A	WD03832A	WD07832A	WD15432A	WD30631A
WD05212A	WD10212A	WD15632A	WD30632A	WD05212A	WD10212A	WD15632A	WD30632A
WD05232A	WD10232A	WD15812A	WD30832A	WD05232A	WD10232A	WD15812A	WD30832A
WD05412A	WD10412A	WD15832A	WD39432A	WD05412A	WD10412A	WD15832A	WD39432A
WD05431A	WD10432A	WD20232A	WD394632A	WD05431A	WD10432A	WD20232A	WD394632A
WD05432A	WD10632A	WD20412A		WD05432A	WD10632A	WD20412A	
WD05632A	WD10712A			WD05632A	WD10712A		
WD05712A	WD10832A			WD05712A	WD10832A		
WD05812A				WD05812A			

POWER BLOCK			
			

5823-0004-002		480034002	
WD02112A	WD05812A	WD12232A	WD12212A
WD02212A	WD05832A	WD12432A	WD12632A
WD02812A	WD07212A	WD12832A	WD12812A
WD03112A	WD07232A	WD15232A	WD15212A
WD03212A	WD07412A	WD15412A	WD15632A
WD03232A	WD07432A	WD15432A	WD15812A
WD03432A	WD07712A	WD15832A	WD20232A
WD03712A	WD07812A	WD20412A	WD20632A
WD03812A	WD07831A	WD20432A	WD25232A
WD03832A	WD07832A	WD25432A	WD25632A
WD05212A	WD10212A	WD30431A	WD25832A
WD05232A	WD10232A	WD30432A	WD30232A
WD05412A	WD10412A	WD39432A	WD30631A
WD05431A	WD10432A		WD30632A
WD05432A	WD10712A		WD30832A
WD05712A	WD10832A		WD394632A

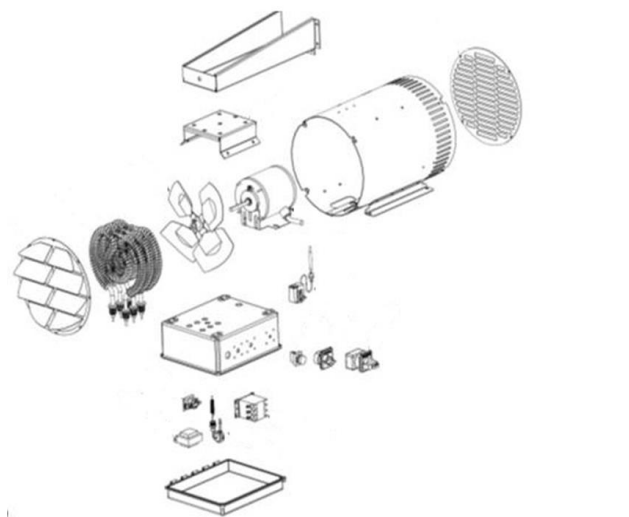







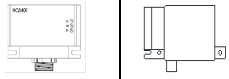

Factory Installed Accessories

CATALOG NUMBER	DESCRIPTION
T	Thermostat
L	Pilot Light
S	Mode/Selector Switch
D	Disconnect Switch
E	Monel Element*
M	Manual Reset
P	Epoxy Coating

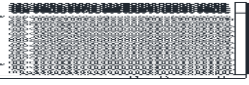
PART	GASKET	KNOB
THERMOSTAT SM/MD UNITS LRG UNITS	5813-11010-000 5206-11009-000 5206-11010-000	3301-11010-000
PILOT LIGHT 120V CONTROL 24V CONTROL	3510-11009-001 3510-11009-000	N/A
MODE SWITCH SM/MD UNITS LRG UNITS	4529-11011-000 4529-11011-001	5206-11009-000
DISCONNECT SWITCH 40AMP 60AMP 100AMP 125AMP	5216-11017-000 5216-11017-001 5216-11017-002 5216-11017-003	5206-11009-000
MONEL ELEMENT	CONTACT FACTORY	
MANUAL RESET SM/MD UNITS LRG UNITS	4520-11017-000 4520-11017-001	N/A
EPOXY COATING	CONTACT FACTORY	



KCJ																			
ELEMENT				LINEAR LIMIT			TR. RELAY												
																			
1802-2056-003 J400B	1802-2044-011 J750B	1802-2044-014 J1007B	1802-2044-228 J1503B	4520-2018-000 J400B	4520-2018-003 J1000B	4520-2018-005 J1500B	5018-11003-003 J503B	410043007 J1006B											
1802-2056-001 J404B	1802-2044-210 J753B	1802-2044-016 J1008B	1802-2044-027 J1504B	J404B	J1003B	J1503B	J753B	J1256B											
1802-2056-000 J407B	1802-2044-009 J754B	1802-2044-023 J1250B	1802-2044-229 J1506B	J407B	J1004B	J1504B	J1003B	J1506B											
1802-2056-002 J408B	1802-2044-008 J757B	1802-2044-222 J1253B	1802-2044-026 J1507B	4520-2018-001 J408B	J1006B	J1506B	J1253B	J2006B											
1802-2044-043 J500B	1802-2044-010 J758B	1802-2044-021 J1254B	1802-2044-028 J1508B	4520-2018-001 J500B	4520-2018-004 J1250B	4520-2018-006 J2003B	J1503B	J2003B											
1802-2044-202 J503B	1802-2044-017 J1000B	1802-2044-223 J1256B	1802-2044-234 J2003B	J503B	J1253B	J2004B	J1006B	J2004B											
1802-2044-041 J504B	1802-2044-216 J1003B	1802-2044-020 J1257B	1802-2044-033 J2004B	4520-2018-002 J507B	J1254B	J2006B	J1256B	J2006B											
1802-2044-040 J507B	1802-2044-015 J1004B	1802-2044-022 J1258B	1802-2044-235 J2006B	J508B	J1257B	J2007B	J1257B	J2007B											
1802-2044-042 J508B	1802-2044-217 J1006B	1802-2044-029 J1500B	1802-2044-032 J2007B	J754B	J1258B	J2008B	J1507B	J2008B											
			1802-2044-034 J2008B	J757B			J1508B	J2008B											
				J758B															
SWITCH		FRONT COVER			CONTROL COVER	THERMOSTAT													
																			
5216-11007-000 J400B J404B J407B J408B J500B J504B J507B J508B J750B J754B J757B J758B J1000B J1004B		5216-2053-000 J503B J753B J1003B J1250B J1254B J1257B J1258B J1500B J1503B J1504B J1506B J2003B J2006B			1402-2192-006 J400B J404B J407B J408B 1402-2192-001 J500B J503B J504B J507B J508B 1402-2192-002 J750B J753B J754B J757B J758B			1402-2192-003 J1000B J1003B J1004B J1006B J1007B J1008B 1402-2192-004 J1250B J1253B J1254B J1256B J1257B J1258B			1402-2192-005 J1500B J1503B J1504B J1506B J1507B J1508B 1402-2192-007 J2003B J2004B J2006B J2007B J2008B			1402-11020-000 ALL MODELS			5813-0024-000 ALL MODELS		
																			

SHA & DBA SERIES

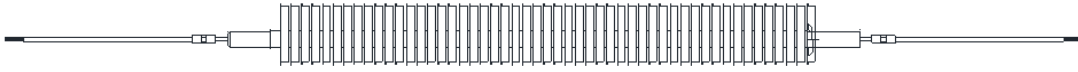

DISCRIPTION	PART NUMBERS					
	120V	208V	240V	277V	347V	600V
*ELEMENT (100 WATTS/FT)						
28" HEATER	1802-2001-047	1802-2001-048	1802-2001-049	NA	NA	NA
3'	1802-2001-053	1802-2001-054	1802-2001-055	1802-2001-056	NA	NA
4'	1802-2001-059	1802-2001-060	1802-2001-061	1802-2001-062	1802-2001-232	NA
5'	1802-2001-065	1802-2001-066	1802-2001-067	1802-2001-068	1802-2001-242	NA
6'	1802-2001-071	1802-2001-072	1802-2001-073	1802-2001-074	1802-2001-252	1802-2001-253
8'	NA	1802-2001-077	1802-2001-078	1802-2001-079	1802-2001-262	1802-2001-263
10'	NA	1802-2001-081	1802-2001-082	1802-2001-083	1802-2001-272	1802-2001-273
*ELEMENT (125 WATTS/FT)						
28" HEATER	1802-2001-085	1802-2001-086	1802-2001-048	1802-2001-049	NA	NA
3'	1802-2001-087	1802-2001-088	1802-2001-054	1802-2001-055	1802-2001-220	NA
4'	1802-2001-089	1802-2001-090	1802-2001-060	1802-2001-061	1802-2001-230	NA
5'	1802-2001-091	1802-2001-092	1802-2001-066	1802-2001-067	1802-2001-240	1802-2001-241
6'	1802-2001-093	1802-2001-094	1802-2001-072	1802-2001-073	1802-2001-250	1802-2001-251
8'	NA	1802-2001-095	1802-2001-077	1802-2001-078	1802-2001-260	1802-2001-261
10'	NA	1802-2001-096	1802-2001-081	1802-2001-082	1802-2001-270	1802-2001-271
*ELEMENT (150 WATTS/FT)						
28" HEATER	1802-2001-051	1802-2001-001	1802-2001-000	1802-2001-052	NA	NA
3'	1802-2001-057	1802-2001-007	1802-2001-006	1802-2001-058	1802-2001-218	NA
4'	1802-2001-063	1802-2001-013	1802-2001-012	1802-2001-064	1802-2001-228	NA
5'	1802-2001-069	1802-2001-019	1802-2001-018	1802-2001-070	1802-2001-238	1802-2001-239
6'	1802-2001-075	1802-2001-025	1802-2001-024	1802-2001-076	1802-2001-248	1802-2001-249
8'	NA	1802-2001-031	1802-2001-030	1802-2001-080	1802-2001-258	1802-2001-259
10'	NA	1802-2001-035	1802-2001-034	1802-2001-084	1802-2001-268	1802-2001-269
*ELEMENT (188 WATTS/FT)						
28" HEATER	1802-2001-005	1802-2001-002	1802-2001-001	1802-2001-000	NA	NA
3'	1802-2001-011	1802-2001-008	1802-2001-007	1802-2001-006	1802-2001-216	NA
4'	1802-2001-017	1802-2001-014	1802-2001-013	1802-2001-012	1802-2001-226	1802-2001-227
5'	1802-2001-023	1802-2001-020	1802-2001-019	1802-2001-018	1802-2001-236	1802-2001-237
6'	1802-2001-029	1802-2001-026	1802-2001-025	1802-2001-024	1802-2001-246	1802-2001-247
8'	NA	1802-2001-032	1802-2001-031	1802-2001-030	1802-2001-256	1802-2001-257
10'	NA	1802-2001-036	1802-2001-035	1802-2001-034	1802-2001-266	1802-2001-267
*ELEMENT (250 WATTS/FT)						
28" HEATER	1802-2001-004	1802-2001-003	1802-2001-002	1802-2001-001	1802-2001-202	NA
3'	1802-2001-010	1802-2001-009	1802-2001-008	1802-2001-007	1802-2001-214	NA
4'	1802-2001-016	1802-2001-015	1802-2001-014	1802-2001-013	1802-2001-224	1802-2001-225
5'	1802-2001-022	1802-2001-021	1802-2001-020	1802-2001-019	1802-2001-234	1802-2001-235
6'	1802-2001-028	1802-2001-027	1802-2001-026	1802-2001-025	1802-2001-244	1802-2001-245
8'	NA	1802-2001-033	1802-2001-032	1802-2001-031	1802-2001-254	1802-2001-255
10'	NA	1802-2001-037	1802-2001-036	1802-2001-035	1802-2001-264	1802-2001-265
* 1, 2 OR 3 ELEMENTS MAY BE REQUIRED. VOLTAGE AND WATTAGE ARE STAMPED ON END OF ELEMENTS. DIVIDE THE WATTAGE BY THE HEATER LENGTH (FEET) TO DETERMINE WATTS/FOOT OF ELEMENT. THEN USE THIS DATA TO DETERMINE PART NUMBER OF HEATING ELEMENT.						

DISCRIPTION	PART NUMBERS					
	120V	208V	240V	277V	347V	600V
LINEAR LIMIT						
28" HEATER	4520-0007-007	4520-0007-007	4520-0007-007	4520-0007-007	4520-0007-007	4520-0007-007
3'	4520-0007-008	4520-0007-008	4520-0007-008	4520-0007-008	4520-0007-008	4520-0007-008
4'	4520-0007-009	4520-0007-009	4520-0007-009	4520-0007-009	4520-0007-009	4520-0007-009
5'	4520-0007-010	4520-0007-010	4520-0007-010	4520-0007-010	4520-0007-010	4520-0007-010
6'	4520-0007-011	4520-0007-011	4520-0007-011	4520-0007-011	4520-0007-011	4520-0007-011
8'	NA	4520-0007-012	4520-0007-012	4520-0007-012	4520-0007-012	4520-0007-012
10'	NA	4520-0007-013	4520-0007-013	4520-0007-013	4520-0007-013	4520-0007-013
DISCONNECT SW.	THERMOSTAT	TRANSFORMER		POWER RELAY		
410170001	2-STAGE 5813-0023-000 SINGLE POLE 5813-0024-000	120V 5018-11003-000 208/240V 5018-11003-001	277V 5018-11003-002 347V 5018-11003-003	24V 5018-2006-000 120V 5018-2021-001	208/240V 5018-2006-002 277V 5018-2006-003	

SLQDB SERIES





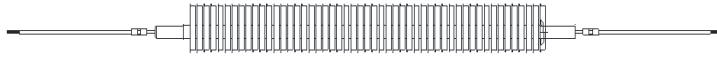

DISCRPTION	PART NUMBERS							
	120V	208V	240V	277V	347V	600V		
*ELEMENT (100 WATTS/FT)								
28" HEATER	1802-2001-047	1802-2001-048	1802-2001-049	NA	NA	NA		
3'	1802-2001-053	1802-2001-054	1802-2001-055	1802-2001-056	NA	NA		
4'	1802-2001-059	1802-2001-060	1802-2001-061	1802-2001-062	1802-2001-232	NA		
5'	1802-2001-065	1802-2001-066	1802-2001-067	1802-2001-068	1802-2001-242	NA		
6'	1802-2001-071	1802-2001-072	1802-2001-073	1802-2001-074	1802-2001-252	1802-2001-253		
8'	NA	1802-2001-077	1802-2001-078	1802-2001-079	1802-2001-262	1802-2001-263		
10'	NA	1802-2001-081	1802-2001-082	1802-2001-083	1802-2001-272	1802-2001-273		
*ELEMENT (125 WATTS/FT)								
28" HEATER	1802-2001-085	1802-2001-086	1802-2001-048	1802-2001-049	NA	NA		
3'	1802-2001-087	1802-2001-088	1802-2001-054	1802-2001-055	1802-2001-220	NA		
4'	1802-2001-089	1802-2001-090	1802-2001-060	1802-2001-061	1802-2001-230	NA		
5'	1802-2001-091	1802-2001-092	1802-2001-066	1802-2001-067	1802-2001-240	1802-2001-241		
6'	1802-2001-093	1802-2001-094	1802-2001-072	1802-2001-073	1802-2001-250	1802-2001-251		
8'	NA	1802-2001-095	1802-2001-077	1802-2001-078	1802-2001-260	1802-2001-261		
10'	NA	1802-2001-096	1802-2001-081	1802-2001-082	1802-2001-270	1802-2001-271		
*ELEMENT (150 WATTS/FT)								
28" HEATER	1802-2001-051	1802-2001-001	1802-2001-000	1802-2001-052	NA	NA		
3'	1802-2001-057	1802-2001-007	1802-2001-006	1802-2001-058	1802-2001-218	NA		
4'	1802-2001-063	1802-2001-013	1802-2001-012	1802-2001-064	1802-2001-228	NA		
5'	1802-2001-069	1802-2001-019	1802-2001-018	1802-2001-070	1802-2001-238	1802-2001-239		
6'	1802-2001-075	1802-2001-025	1802-2001-024	1802-2001-076	1802-2001-248	1802-2001-249		
8'	NA	1802-2001-031	1802-2001-030	1802-2001-080	1802-2001-258	1802-2001-259		
10'	NA	1802-2001-035	1802-2001-034	1802-2001-084	1802-2001-268	1802-2001-269		
*ELEMENT (188 WATTS/FT)								
24" HEATER	1802-2001-038	1802-2001-039	1802-2001-040	1802-2001-041	1802-2001-200	NA		
28"	1802-2001-005	1802-2001-002	1802-2001-001	1802-2001-000	NA	NA		
3'	1802-2001-011	1802-2001-008	1802-2001-007	1802-2001-006	1802-2001-216	NA		
4'	1802-2001-017	1802-2001-014	1802-2001-013	1802-2001-012	1802-2001-226	1802-2001-227		
5'	1802-2001-023	1802-2001-020	1802-2001-019	1802-2001-018	1802-2001-236	1802-2001-237		
6'	1802-2001-029	1802-2001-026	1802-2001-025	1802-2001-024	1802-2001-246	1802-2001-247		
8'	NA	1802-2001-032	1802-2001-031	1802-2001-030	1802-2001-256	1802-2001-257		
10'	NA	1802-2001-036	1802-2001-035	1802-2001-034	1802-2001-266	1802-2001-267		
LINEAR LIMIT		DISCONNECT SW.	THERMOSTAT					
28" HEATER	4520-0007-007	410170001	2-STAGE				SINGLE POLE	
3'	4520-0007-008		5813-0023-000				410129002	
4'	4520-0007-009							
5'	4520-0007-010							
6'	4520-0007-011							
8'	4520-0007-012							
10'	4520-0007-013							

ST SERIES



DISCRIPTION	PART NUMBERS					
	120V	208V	240V	277V	347V	600V
*ELEMENT (125 WATTS/FT)						
28" HEATER	1802-2001-085	1802-2001-086	1802-2001-048	1802-2001-049	NA	NA
3'	1802-2001-087	1802-2001-088	1802-2001-054	1802-2001-055	1802-2001-220	NA
4'	1802-2001-089	1802-2001-090	1802-2001-060	1802-2001-061	1802-2001-230	NA
5'	1802-2001-091	1802-2001-092	1802-2001-066	1802-2001-067	1802-2001-240	1802-2001-241
6'	1802-2001-093	1802-2001-094	1802-2001-072	1802-2001-073	1802-2001-250	1802-2001-251
8'	NA	1802-2001-095	1802-2001-077	1802-2001-078	1802-2001-260	1802-2001-261
10'	NA	1802-2001-096	1802-2001-081	1802-2001-082	1802-2001-270	1802-2001-271
*ELEMENT (188 WATTS/FT)						
28" HEATER	1802-2001-005	1802-2001-002	1802-2001-001	1802-2001-000	NA	NA
3'	1802-2001-011	1802-2001-008	1802-2001-007	1802-2001-006	1802-2001-216	NA
4'	1802-2001-017	1802-2001-014	1802-2001-013	1802-2001-012	1802-2001-226	1802-2001-227
5'	1802-2001-023	1802-2001-020	1802-2001-019	1802-2001-018	1802-2001-236	1802-2001-237
6'	1802-2001-029	1802-2001-026	1802-2001-025	1802-2001-024	1802-2001-246	1802-2001-247
8'	NA	1802-2001-032	1802-2001-031	1802-2001-030	1802-2001-256	1802-2001-257
10'	NA	1802-2001-036	1802-2001-035	1802-2001-034	1802-2001-266	1802-2001-267
*ELEMENT (250 WATTS/FT)						
28" HEATER	1802-2001-004	1802-2001-003	1802-2001-002	1802-2001-001	1802-2001-202	NA
3'	1802-2001-010	1802-2001-009	1802-2001-008	1802-2001-007	1802-2001-214	NA
4'	1802-2001-016	1802-2001-015	1802-2001-014	1802-2001-013	1802-2001-224	1802-2001-225
5'	1802-2001-022	1802-2001-021	1802-2001-020	1802-2001-019	1802-2001-234	1802-2001-235
6'	1802-2001-028	1802-2001-027	1802-2001-026	1802-2001-025	1802-2001-244	1802-2001-245
8'	NA	1802-2001-033	1802-2001-032	1802-2001-031	1802-2001-254	1802-2001-255
10'	NA	1802-2001-037	1802-2001-036	1802-2001-035	1802-2001-264	1802-2001-265

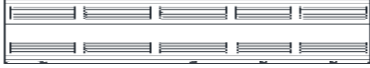

DISCRIPTION	PART NUMBERS					
	120V	208V	240V	277V	347V	600V
LINEAR LIMIT						
28" HEATER	4520-2018-001	4520-2018-001	4520-2018-001	4520-2018-001	4520-2018-001	4520-2018-001
3'	4520-2018-002	4520-2018-002	4520-2018-002	4520-2018-002	4520-2018-002	4520-2018-002
4'	4520-2018-003	4520-2018-003	4520-2018-003	4520-2018-003	4520-2018-003	4520-2018-003
5'	4520-2018-004	4520-2018-004	4520-2018-004	4520-2018-004	4520-2018-004	4520-2018-004
6'	4520-2018-005	4520-2018-005	4520-2018-005	4520-2018-005	4520-2018-005	4520-2018-005
8'	NA	4520-2018-006	4520-2018-006	4520-2018-006	4520-2018-006	4520-2018-006
10'	NA	4520-2018-007	4520-2018-007	4520-2018-007	4520-2018-007	4520-2018-007
DISCONNECT SW.	THERMOSTAT	TRANSFORMER RELAY		J-BOX COVER	FRONT COVER	
						
DS	2-STAGE 5813-0023-000 SINGLE POLE 5813-0024-000	120V 5018-11003-000 208/240V 5018-11003-001	277V 5018-11003-002 347V 5018-11003-003	ALL MODELS 1402-2250-000	1402-2251-000 1402-2251-001 1402-2251-002 1402-2251-003 1402-2251-004 1402-2251-005 1402-2251-006	28" 3' 4' 5' 6' 8' 10'

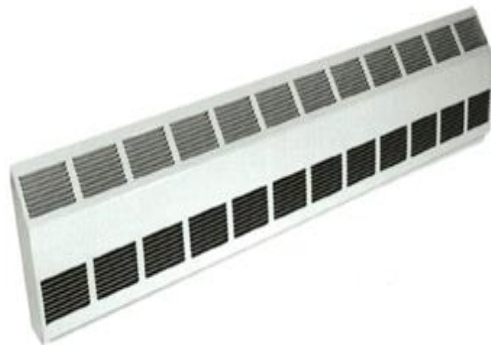
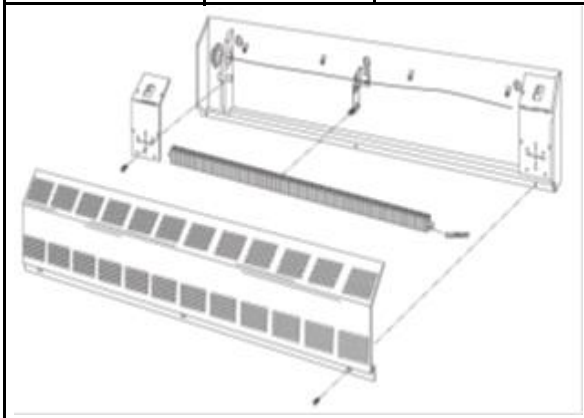

CSH, DSH, CPH & DPH SERIES









DISCRIPTION	PART NUMBERS					
	120V	208V	240V	277V	347V	600V
*ELEMENT (125 WATTS/FT)						
28" HEATER	1802-2001-085	1802-2001-086	1802-2001-048	1802-2001-049	NA	NA
3'	1802-2001-087	1802-2001-088	1802-2001-054	1802-2001-055	1802-2001-220	NA
4'	1802-2001-089	1802-2001-090	1802-2001-060	1802-2001-061	1802-2001-230	NA
5'	1802-2001-091	1802-2001-092	1802-2001-066	1802-2001-067	1802-2001-240	1802-2001-241
6'	1802-2001-093	1802-2001-094	1802-2001-072	1802-2001-073	1802-2001-250	1802-2001-251
8'	NA	1802-2001-095	1802-2001-077	1802-2001-078	1802-2001-260	1802-2001-261
10'	NA	1802-2001-096	1802-2001-081	1802-2001-082	1802-2001-270	1802-2001-271
*ELEMENT (188 WATTS/FT)						
28" HEATER	1802-2001-005	1802-2001-002	1802-2001-001	1802-2001-000	NA	NA
3'	1802-2001-011	1802-2001-008	1802-2001-007	1802-2001-006	1802-2001-216	NA
4'	1802-2001-017	1802-2001-014	1802-2001-013	1802-2001-012	1802-2001-226	1802-2001-227
5'	1802-2001-023	1802-2001-020	1802-2001-019	1802-2001-018	1802-2001-236	1802-2001-237
6'	1802-2001-029	1802-2001-026	1802-2001-025	1802-2001-024	1802-2001-246	1802-2001-247
8'	NA	1802-2001-032	1802-2001-031	1802-2001-030	1802-2001-256	1802-2001-257
10'	NA	1802-2001-036	1802-2001-035	1802-2001-034	1802-2001-266	1802-2001-267
*ELEMENT (250 WATTS/FT)						
28" HEATER	1802-2001-004	1802-2001-003	1802-2001-002	1802-2001-001	1802-2001-202	NA
3'	1802-2001-010	1802-2001-009	1802-2001-008	1802-2001-007	1802-2001-214	NA
4'	1802-2001-016	1802-2001-015	1802-2001-014	1802-2001-013	1802-2001-224	1802-2001-225
5'	1802-2001-022	1802-2001-021	1802-2001-020	1802-2001-019	1802-2001-234	1802-2001-235
6'	1802-2001-028	1802-2001-027	1802-2001-026	1802-2001-025	1802-2001-244	1802-2001-245
8'	NA	1802-2001-033	1802-2001-032	1802-2001-031	1802-2001-254	1802-2001-255
10'	NA	1802-2001-037	1802-2001-036	1802-2001-035	1802-2001-264	1802-2001-265

* 1, 2 OR 3 ELEMENTS MAY BE REQUIRED. VOLTAGE AND WATTAGE ARE STAMPED ON END OF ELEMENTS. DIVIDE THE WATTAGE BY THE HEATER LENGTH (FEET) TO DETERMINE WATTS/FOOT OF ELEMENT. THEN USE THIS DATA TO DETERMINE PART NUMBER OF HEATING ELEMENT.



DISCRIPTION	PART NUMBERS					
	120V	208V	240V	277V	347V	600V
LINEAR LIMIT						
28" HEATER	4520-0007-007	4520-0007-007	4520-0007-007	4520-0007-007	4520-0007-007	4520-0007-007
3'	4520-0007-008	4520-0007-008	4520-0007-008	4520-0007-008	4520-0007-008	4520-0007-008
4'	4520-0007-009	4520-0007-009	4520-0007-009	4520-0007-009	4520-0007-009	4520-0007-009
5'	4520-0007-010	4520-0007-010	4520-0007-010	4520-0007-010	4520-0007-010	4520-0007-010
6'	4520-0007-011	4520-0007-011	4520-0007-011	4520-0007-011	4520-0007-011	4520-0007-011
8'	NA	4520-0007-012	4520-0007-012	4520-0007-012	4520-0007-012	4520-0007-012
10'	NA	4520-0007-013	4520-0007-013	4520-0007-013	4520-0007-013	4520-0007-013





DISCONNECT SW.	THERMOSTAT	TRANSFORMER RELAY		24V TRANSFORMER	PNEUMATIC CONTROL
					
410170001	2-STAGE 5813-0023-000 SINGLE POLE 5813-0024-000	120V 5018-11003-000 208/240V 5018-11003-001	277V 5018-11003-002 347V 5018-11003-003	208/240V PRIMARY 490026001 277V PRIMARY 490026002	ALL MODELS 5216-7027-005

CIRCUIT BREAKER	POWER RELAY	
		
2-POLE, 30A 1226-7009-013 2-POLE, 60A 1226-7009-010 3-POLE, 30A 1226-7009-005 3-POLE, 60A 1226-7009-002	24V 5018-2017-001 120V 5018-2021-001 208/240V 5018-2021-002	277V 410171003

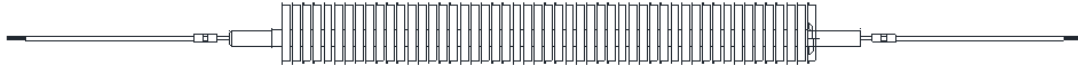

DBSL SERIES

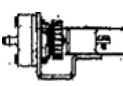

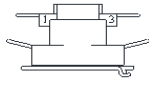
DISCRIPTION	PART NUMBERS					
	120V	208V	240V	277V	347V	600V
*ELEMENT (100 WATTS/FT)						
28" HEATER	1802-2001-047	1802-2001-048	1802-2001-049	NA	NA	NA
3'	1802-2001-053	1802-2001-054	1802-2001-055	1802-2001-056	NA	NA
4'	1802-2001-059	1802-2001-060	1802-2001-061	1802-2001-062	1802-2001-232	NA
5'	1802-2001-065	1802-2001-066	1802-2001-067	1802-2001-068	1802-2001-242	NA
6'	1802-2001-071	1802-2001-072	1802-2001-073	1802-2001-074	1802-2001-252	1802-2001-253
8'	NA	1802-2001-077	1802-2001-078	1802-2001-079	1802-2001-262	1802-2001-263
10'	NA	1802-2001-081	1802-2001-082	1802-2001-083	1802-2001-272	1802-2001-273
*ELEMENT (125 WATTS/FT)						
28" HEATER	1802-2001-085	1802-2001-086	1802-2001-048	1802-2001-049	NA	NA
3'	1802-2001-087	1802-2001-088	1802-2001-054	1802-2001-055	1802-2001-220	NA
4'	1802-2001-089	1802-2001-090	1802-2001-060	1802-2001-061	1802-2001-230	NA
5'	1802-2001-091	1802-2001-092	1802-2001-066	1802-2001-067	1802-2001-240	1802-2001-241
6'	1802-2001-093	1802-2001-094	1802-2001-072	1802-2001-073	1802-2001-250	1802-2001-251
8'	NA	1802-2001-095	1802-2001-077	1802-2001-078	1802-2001-260	1802-2001-261
10'	NA	1802-2001-096	1802-2001-081	1802-2001-082	1802-2001-270	1802-2001-271
*ELEMENT (150 WATTS/FT)						
28" HEATER	1802-2001-051	1802-2001-001	1802-2001-000	1802-2001-052	NA	NA
3'	1802-2001-057	1802-2001-007	1802-2001-006	1802-2001-058	1802-2001-218	NA
4'	1802-2001-063	1802-2001-013	1802-2001-012	1802-2001-064	1802-2001-228	NA
5'	1802-2001-069	1802-2001-019	1802-2001-018	1802-2001-070	1802-2001-238	1802-2001-239
6'	1802-2001-075	1802-2001-025	1802-2001-024	1802-2001-076	1802-2001-248	1802-2001-249
8'	NA	1802-2001-031	1802-2001-030	1802-2001-080	1802-2001-258	1802-2001-259
10'	NA	1802-2001-035	1802-2001-034	1802-2001-084	1802-2001-268	1802-2001-269
*ELEMENT (188 WATTS/FT)						
24" HEATER	1802-2001-038	1802-2001-039	1802-2001-040	1802-2001-041	1802-2001-200	NA
28"	1802-2001-005	1802-2001-002	1802-2001-001	1802-2001-000	NA	NA
3'	1802-2001-011	1802-2001-008	1802-2001-007	1802-2001-006	1802-2001-216	NA
4'	1802-2001-017	1802-2001-014	1802-2001-013	1802-2001-012	1802-2001-226	1802-2001-227
5'	1802-2001-023	1802-2001-020	1802-2001-019	1802-2001-018	1802-2001-236	1802-2001-237
6'	1802-2001-029	1802-2001-026	1802-2001-025	1802-2001-024	1802-2001-246	1802-2001-247
8'	NA	1802-2001-032	1802-2001-031	1802-2001-030	1802-2001-256	1802-2001-257
10'	NA	1802-2001-036	1802-2001-035	1802-2001-034	1802-2001-266	1802-2001-267
*ELEMENT (250 WATTS/FT)						
28" HEATER	1802-2001-004	1802-2001-003	1802-2001-002	1802-2001-001	1802-2001-202	NA
3'	1802-2001-010	1802-2001-009	1802-2001-008	1802-2001-007	1802-2001-214	NA
4'	1802-2001-016	1802-2001-015	1802-2001-014	1802-2001-013	1802-2001-224	1802-2001-225
5'	1802-2001-022	1802-2001-021	1802-2001-020	1802-2001-019	1802-2001-234	1802-2001-235
6'	1802-2001-028	1802-2001-027	1802-2001-026	1802-2001-025	1802-2001-244	1802-2001-245
8'	NA	1802-2001-033	1802-2001-032	1802-2001-031	1802-2001-254	1802-2001-255
10'	NA	1802-2001-037	1802-2001-036	1802-2001-035	1802-2001-264	1802-2001-265
						
LINEAR LIMIT	DISCONNECT SW.		THERMOSTAT	P.E. SWITCH		
28" HEATER	4520-0007-007	410170001	2-STAGE	410172001		
3'	4520-0007-008		5813-0023-000			
4'	4520-0007-009		SINGLE POLE			
5'	4520-0007-010		5813-0024-000			
6'	4520-0007-011					
8'	4520-0007-012					
10'	4520-0007-013					
						
TRANSFORMER	POWER RELAY					
120V	277V	24V	208/240V			
5018-11003-000	5018-11003-002	410171001	410171003			
208/240V	347V	120V				
5018-11003-001	5018-11003-003	410171002				



ARL SERIES

ELEMENT

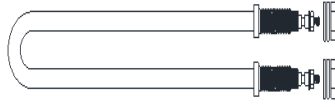
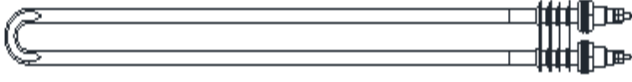

1802-7076-001

L1511B

1802-7076-008

L4521B

HE45240

L4521

1802-7076-003

L2021B

1802-7076-010

L4541B

HE45480

L4541

1802-7076-005

L2041B

1802-7076-011

L4561B

HE20240

L6023

1802-7076-006

L2061B

1802-7076-009

L4571B

HE20480

L6043

1802-7076-004

L2071B

1802-7076-007

L4581B

HE45480

L13543

1802-7076-002

L2081B

RELECTOR

891755004

L1511B

891755002

L4581B

L4541B

L4521B



1.5KW Portable



4.5KW Portable

BRM SERIES

ELEMENT

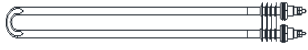

1802-7076-002 M2081B M6083B	1802-7076-007 M4581B M13583B	1802-2110-007 M6043A	HE45208 M4581 M13583	HE20208 M6083
1802-7076-003 M2021B M6023B	1802-7076-008 M4521B M13523B	1802-2110-009 M4581A M13583A	HE45240 M4521 M13523	HE20240 M6023
1802-7076-004 M6071B	1802-7076-009 M13571B	1802-2110-011 M4521A M13523A	HE45480 M4541 M13543	HE20480 M6043
1802-7076-005 M2041B M6043B	1802-7076-010 M4541B M13543B	1802-2110-015 M4541A M13543A	HE45600 M13563	HE20600 M6063
1802-7076-006 M2061B M6063B	1802-7076-011 M4561B M13563B	1802-2110-016 M13563A		

NOTES

6KW AND 13.5KW UNITS TAKE THREE ELEMENTS



2.0 KW

6.0 KW Fixed

4.5 KW Fixed

13.5 KW Fixed w/Grille

REFLECTOR

891755004 M6023B M6043B	891755002 M13523B M13543B M4521B M4541B
--------------------------------------	--













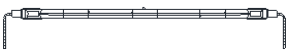

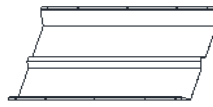

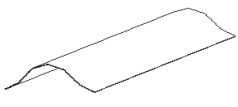
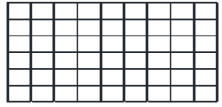
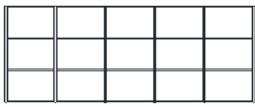

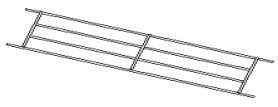
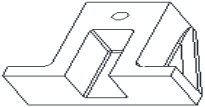
CRN SERIES

ELEMENT

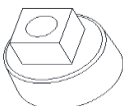



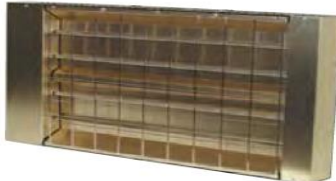







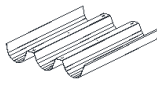

1802-2115-001 N1011A	1802-2115-013 N2001A	1802-7077-001 N1011B	1802-7077-009 N2001B
1802-2115-004 N1021A	1802-2115-015 N2021A	1802-7077-003 N1021B	1802-7077-010 N2021B
1802-2115-006 N1031A	1802-2115-017 N2031A	1802-7077-002 N1081B	1802-7077-012 N2031B
1802-2115-005 N1071A	1802-2115-016 N2071A	1802-7077-004 N1511B	1802-7077-011 N2071B
1802-2115-008 N1501A	1802-2115-018 N2501A	1802-7077-006 N1521B	1802-7077-013 N2501B
1802-2115-007 N1511A	1802-2115-020 N2521A	1802-7077-008 N1531B	1802-7077-014 N2521B
1802-2115-010 N1521A	1802-2115-022 N2531A	1802-7077-007 N1571B	1802-7077-016 N2531B
1802-2115-012 N1531A	1802-2115-021 N2571A	1802-7077-005 N1581B	1802-7077-015 N2571B
1802-2115-011 N1571A			

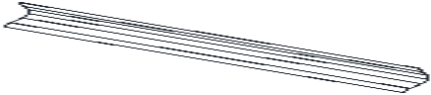

FRR & CMRR SERIES			
ELEMENT			
			
1802-0070-509 RR22012A	1802-2113-501 RR41512A	1802-2119-500 RR10512A	1802-2151-001 RR26164
1802-0070-550 RR35724A	1802-2113-516 RR53024A	RR11012A	1802-2151-000 RR26168
REFLECTOR			
			
5007-2013-000 RR41512A	5007-2020-000 RR22012A	5007-2021-000 RR10512A	5007-2027-000 RR26164
5007-2013-001 RR53024A	5007-2020-001 RR35724A	RR11012A	RR26168
WIRE GUARD			
			
2504-2014-000 RR35724A	2504-2015-000 RR22012A	2504-2016-000 RR41512A	2504-2017-000 RR10512A
		2504-2016-001 RR53024A	RR11012A
		2504-2016-002 RR26164	
		RR26168	
CERAMIC BLOCK		SWITCH	
			
1224-0049-000 RR22012A	1224-2006-000 RR10512A	410024000 RR11012A	5216-11009-000 RR22012A
RR26164	RR11012A		RR35724A
RR26168			
RR35724A			
ELEMENT BUSHING	CORD	CHAIN 4'	"S" HOOKS
			
1213-0070-000 RR22012A	1420-2016-000 RR10512A	1404-2000-001 RR10512A	2706-2000-000 RR10512A
RR26164	RR41512A	RR11012A	RR11012A
RR26168	1420-2016-008 RR11012A	RR22012A	RR22012A
RR35724A	1420-2016-002 RR22012A	RR35724A	RR35724A
	1420-2031-000 RR35724A	RR41512A	RR41512A
	1420-2016-001 RR53024A	RR53024A	RR53024A
			

FRP/FRS SERIES RADIANT HEATERS

ELEMENTS					REFLECTOR			
								
PART NUMBER	TYPE	VOLTS	WATTS	USED WITH FIXTURE	5007-2003-000	5007-2003-001	5007-2003-002	
2MS08208 2MS08240 2MS08277 2MS08347 2MS08480 2MS08600	METAL SHEATH	208 240 277 347 480 600	850	RP22 RS22 RP32 RS32	RP223ASA RS223ASA	RP233ASA RS233ASA	RP243ASA RS243ASA	
2QT10208 2QT10240 2QT10277 NA	QUARTS TUBE	208 240 277 NA	1000		5007-2010-000 RP2235A RS2235A	5007-2010-001 RP2335A RS2335A	5007-2010-002 RP2435A RS2435A	
2QL16208 2QL16240 2QL16277 2QL16347 2QL16480 2QL16600	QUARTS LAMP	208 240 277 347 480 600	1600		5007-2011-000 RP226ASA RS226ASA	5007-2011-001 RP236ASA RS236ASA	5007-2011-002 RP246ASA RS246ASA	
3MS15208 3MS15240 3MS15277 3MS15347 3MS15480 3MS15600	METAL SHEATH	208 240 277 347 480 600	1500		RP23 RS23 RP33 RS33	5007-2009-000 RP2265A RP2295A RS2265A RS2295A	5007-2009-001 RP2365A RP2395A RS2365A RS2395A	5007-2009-002 RP2465A RP2495A RS2465A RS2495A
3QT15208 3QT15240 3QT15277 3QT15347 3QT15480 3QT15600	QUARTS TUBE	208 240 277 347 480 600	1500					
3QL25208 3QL25240 3QL25277 3QL25347 3QL25480 3QL25600	QUARTS LAMP	208 240 277 347 480 600	2500			5007-2008-000 RP323ASA RS323ASA	5007-2008-001 RP333ASA RS333ASA	5007-2008-002 RP343ASA RS343ASA
4MS20208 4MS20240 4MS20277 4MS20347 4MS20480 4MS20600	METAL SHEATH	208 240 277 347 480 600	2000	5007-2017-000 RP3235A RS3235A		5007-2017-001 RP3335A RS3335A	5007-2017-002 RP3435A RS3435A	
4QT20208 4QT20240 4QT20277 4QT20347 4QT20480 4QT20600	QUARTS TUBE	208 240 277 347 480 600	2000	5007-2018-000 RP326ASA RS326ASA		5007-2018-001 RP336ASA RS336ASA	5007-2018-002 RP346ASA RS346ASA	
4QL36347 4QL36480 4QL36600	QUARTS LAMP	347 480 600	3650	5007-2016-000 RP3265A RP3295A RS3265A RS3295A		5007-2016-001 RP3365A RP3395A RS3365A RS3395A	5007-2016-002 RP3465A RP3495A RS3465A RS3495A	
					ELEMENT TERM BUSH*		TERMINAL BLOCK*	
								
					ALL MODELS 1213-0070-000	ALL MODELS 1224-0049-000		
					NOTES * FOUR REQUIRED ON 2 ELEMENT AND SIX FOR 3 ELEMENT FIXTURES			
					 			

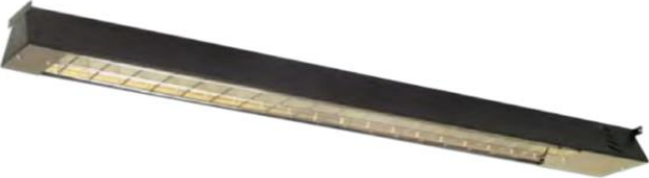

HRK SERIES			
ELEMENT		REFLECTOR	
			
1802-2113-501 RK41512A	1802-2113-515 RK53020A	5007-2013-000 RK41512A RK42020A RK42024A RK42027A RK42034A RK42048A RK42060A	5007-2013-001 RK53020A RK53024A RK53027A RK53034A RK53048A RK53060A
1802-2113-509 RK42020A	1802-2113-516 RK53024A		
1802-2113-510 RK42024A	1802-2113-517 RK53027A		
1802-2113-511 RK42027A	1802-2113-518 RK53034A		
1802-2113-512 RK42034A	1802-2113-519 RK53048A		
1802-2113-513 RK42048A	1802-2113-520 RK53060A		
1802-2113-514 RK42060A			
CHAIN 2 REQ.	"S" HOOK 4 REQ.		
			
1404-2000-001 ALL MODELS	2706-2000-000 ALL MODELS	1402-2275-000 ALL MODELS	1402-2275-001 ALL MODELS
			

QHRA & QVRC SERIES		
ELEMENT	QHRA66	QHRA11
<p>PICTURE NOT AVAILABLE</p>		
<p>IFCQL115A HRA11115W HRARC11115W</p>	<p>IFCQL420A HRA66420BA VRC4420SG VRC4440DWG VRC4440DTG</p>	
<p>2 ELEMENTS REQ ON 4000 WATT MODELS</p>		
QVRC4440DWG	QVRC4440DTG	QVRC4420SG
		

RCC COVE HEATERS (C & D SERIES)

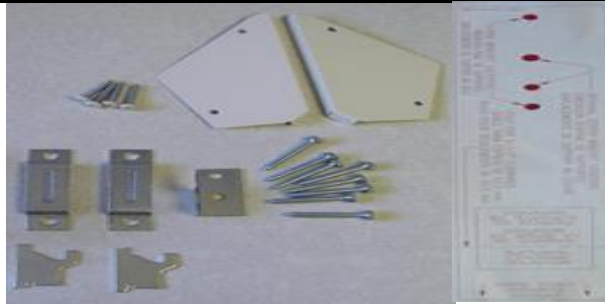
PARTS KIT*

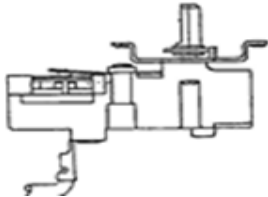

WHITE 3303-2032-000	DOVE GRAY 3303-2032-001	DESERT TAN 3303-2032-002
CENTER SUP BRACKET**	THERMOSTAT	THERMOSTAT KNOB
		
ALL MODELS 1215-2309-000	ALL MODELS 410129001	ALL MODELS 3301-2020-006













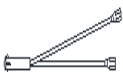

NOTES

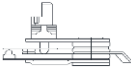

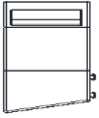

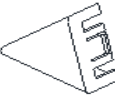





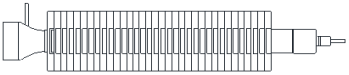
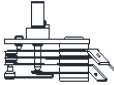

REPLACE HEATER IF FRONT COVER OR ELEMENT IS NEEDED

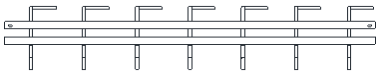
*** PARTS KIT INCLUDES MOUNTING BRACKETS, MOUNTING TEMPLATE, AND END CAPS**



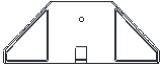

**** 1500 & 1800 WATT MODELS TAKE TWO CENTER SUPPORT BRACKETS**





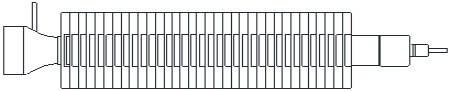
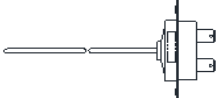
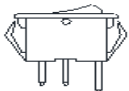
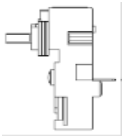
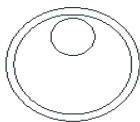

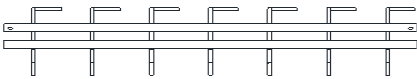



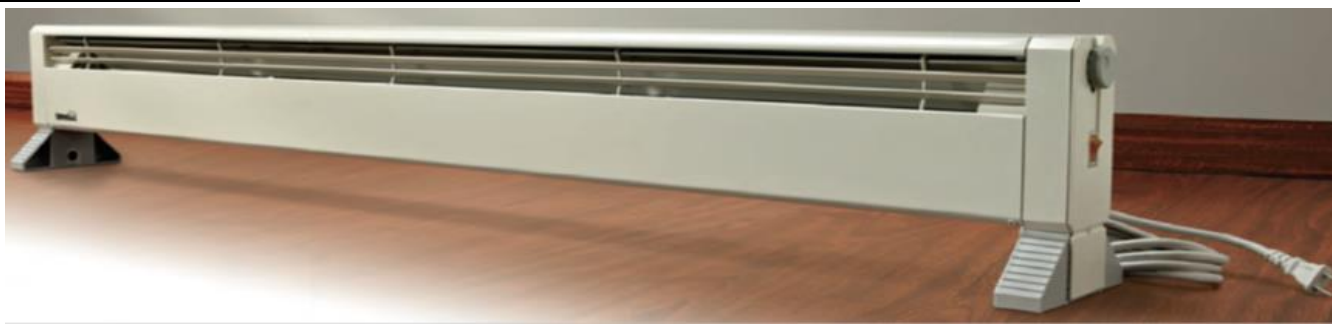

FBE SERIES					
ELEMENT		SWITCH			LIGHT
					
1802-2087-000 FBE15002C FBE15002CA		5216-2007-000 FBE1000A FBE1200 FBE1250A	5216-2010-000 FBE15002 FBE15002A	5216-2027-000 FBE15002B FBE15002C FBE15002CA	3510-2008-001 FBE1504C
LIMIT	THERMOSTAT	KNOB		FACE PLATE	
					
4520-2011-004 FBE1500C FBE15002A FBE15002B FBE15002C FBE15002CA	5813-2058-001 FBE1200 FBE1200C FBE1500C FBE15002B FBE15002C FBE15002CA FBE1504C	3301-2017-000 FBE1000A FBE1250A FBE15002 FBE15002A	3301-2011-003 FBE1200 FBE1200C FBE1500C FBE15002B FBE15002C FBE15002CA FBE1504C	1402-2122-139 FBE1000A	1402-2122-136 FBE15002
				1402-2122-141 FBE1200	1402-2122-138 FBE15002A
				1402-2122-125 FBE1200C	1402-2122-142 FBE15002B
				1402-2122-140 FBE1250A	1402-2122-626 FBE15002CA
END CAP RIGHT	END CAP LEFT	LEG RIGHT	LEG LEFT	CORD	CONTROL COVER
					
1800-2047-001 FBE1200C FBE1500C FBE15002C FBE15002CA FBE1504C	1800-2048-001 FBE1200C FBE1500C FBE15002C FBE15002CA FBE1504C	3507-2004-001 FBE1200C FBE1500C FBE15002C FBE15002CA FBE1504C	3507-2005-001 FBE1200C FBE1500C FBE15002C FBE15002CA FBE1504C	1420-2027-001 FBE15002C 1420-11013-000 FBE15002CA	1402-2243-001 FBE15002B FBE15002C FBE15002CA
					

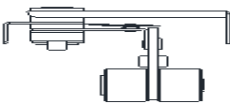
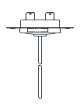
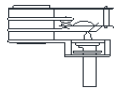
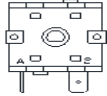
LFP SERIES					
ELEMENT		THERMOSTAT		LIMIT	
					
1802-2067-023 LFP6152D LFP6152E LFP6152EA	1802-2067-001 LFP675D	5813-2019-000 LFP6152 LFP6152D LFP6152E LFP6152EA	5813-2001-000 LFP675 LFP675D	410163004 LFP6152 LFP6152D LFP6152E LFP6152EA	4520-2010-001 LFP675 LFP675D
GRILLE	LIGHT	DIODE BRIDGE	FRONT COVER	CORD	
					
2501-2012-015 LFP6152 LFP6152D LFP6152E LFP6152EA	2501-2012-013 LFP675 LFP675D	3510-2006-000 LFP6152 LFP6152D LFP6152E LFP6152EA	DBKIT LFP6152 LFP6152D LFP6152E LFP6152EA	1402-2066-609 LFP6152EA	1420-11013-000 LFP6152D LFP6152E LFP6152EA
KNOB	LEG	SWITCH	END CAP		
					
3301-2011-001 LFP6152 LFP6152D LFP6152E LFP6152EA LFP675 LFP675D	3507-2003-000 LFP6152 LFP6152D LFP6152E LFP6152EA LFP675 LFP675D	5216-2007-000 LFP6152 LFP6152D LFP6152E LFP6152EA LFP675 LFP675D	1800-2027-000 LFP6152 LFP6152D LFP6152E LFP6152EA LFP675 LFP675D		

FHP SERIES

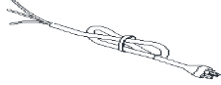

ELEMENT		LIMIT		SWITCH
				
1802-2067-001 FHP0750KCT FHP0750KCTA FHP0750T FHP0750TA	1802-2067-023 FHP1500KCT FHP1500KCTA FHP1500T FHP1500TA	4520-0011-000 FHP0750KCT FHP0750KCTA FHP0750T FHP0750TA	410163004 FHP1500KCT FHP1500KCTA FHP1500T FHP1500TA	5216-2007-000 FHP0750KCT FHP0750KCTA FHP0750T FHP0750TA FHP1500KCT FHP1500KCTA FHP1500T FHP1500TA
THERMOSTAT	KNOB	FRONT COVER		END CAP
				
5813-11012-000 FHP0750KCT FHP0750KCTA FHP0750T FHP0750TA FHP1500KCT FHP1500KCTA FHP1500T FHP1500TA	3301-2011-005 FHP0750KCT FHP0750KCTA FHP0750T FHP0750TA FHP1500KCT FHP1500KCTA FHP1500T FHP1500TA	1402-2066-607 FHP0750KCT FHP0750KCTA FHP0750T FHP0750TA	1402-2066-609 FHP1500KCT FHP1500KCTA FHP1500T FHP1500TA	1800-2027-000 FHP0750KCT FHP0750KCTA FHP0750T FHP0750TA FHP1500KCT FHP1500KCTA FHP1500T FHP1500TA
GRILLE		LEGS (2 REQ)	CORD	
				
2501-2012-013 FHP0750KCT FHP0750KCTA FHP0750T FHP0750TA	2501-2012-015 FHP1500KCT FHP1500KCTA FHP1500T FHP1500TA	3507-2003-000 FHP0750KCT FHP0750KCTA FHP0750T FHP0750TA FHP1500KCT FHP1500KCTA FHP1500T FHP1500TA	1420-11013-000 FHP0750KCT FHP0750KCTA FHP0750T FHP0750TA FHP1500KCT FHP1500KCTA FHP1500T FHP1500TA	



WPC SERIES			
ELEMENT	TIP OVER SW.	LIMIT	THERMOSTAT
			
1802-10822-000 WPC1500A 1802-11017-000 (500W) 1802-11017-001 (1000W) WPC1500B WPC1500C	5216-11004-000 WPC1500A	410122002 WPC1500A 4520-11004-003 WPC1500B WPC1500C	5813-2092-001 WPC1500A WPC1500B WPC1500C
4 POSITION SW.	PORT SWITCH	LIGHT RED	PILOT LIGHT AMBER
			
5216-2071-000 WPC1500A WPC1500B WPC1500C	5216-2073-000 WPC1500A WPC1500B WPC1500C	3510-2021-002 WPC1500A 3510-2021-004 WPC1500B WPC1500C	3510-11518-000 WPC1500A WPC1500B WPC1500C
WHEEL KIT (2 REQ)	HOLE PLUG (2 REQ)	CORD	KNOB (2 REQ)
			
1205-10305-000 WPC1500A WPC1500B WPC1500C	4506-2022-000 WPC1500A WPC1500B WPC1500C	1420-2029-009 WPC1500A WPC1500B WPC1500C	3301-2058-000 WPC1500A WPC1500B WPC1500C



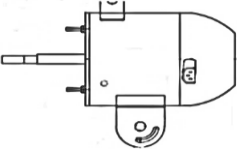
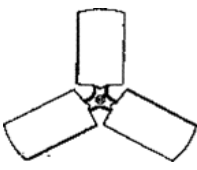
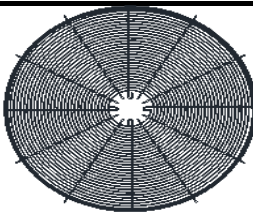

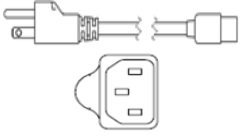





SAFETY YELLOW HIGH PERFORMANCE AIR CIRCULATOR AF30H

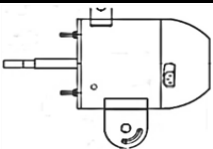
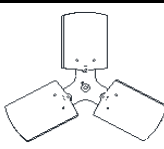
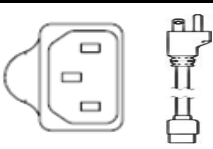
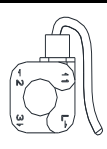

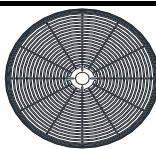

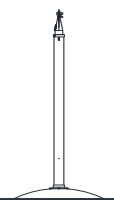

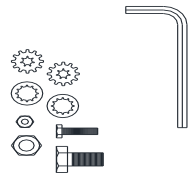
MOTOR	BLADE	GUARD (2 REQ)
		
<p align="center">3900-11014-000 AF30HA</p>	<p align="center">1210-2026-000 AF30H AF30HA</p>	<p align="center">372-079-Y AF30H AF30HA</p>
SWITCH		CORD
		
<p align="center">5216-2051-001 AF30H</p>	<p align="center">1016-11054-001 AF30HA</p>	<p align="center">1420-11004-000 AF30HA</p>

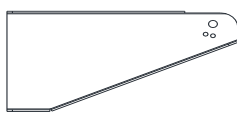
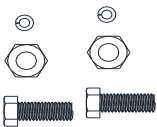
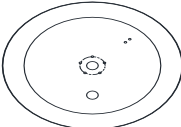
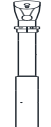
PLUG CONFIGURATION ABOVE IS ONLY TYPE AVAILABLE, IF MOTORS USE DIFFERENT CONFIGURATION THE MOTOR MUST BE REPLACED AS WELL.

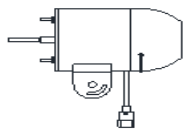
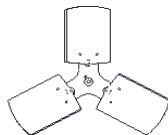
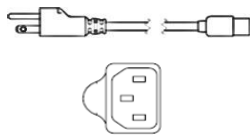
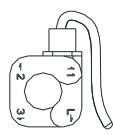

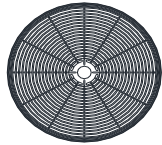
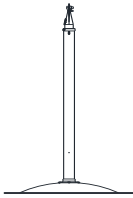
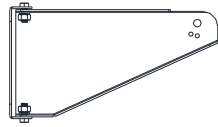
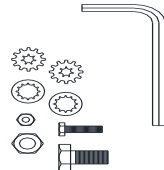

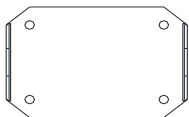

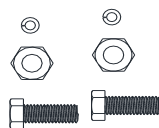
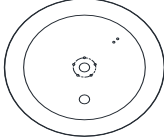



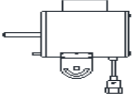
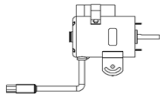
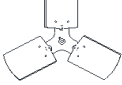

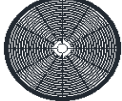

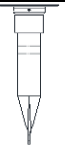
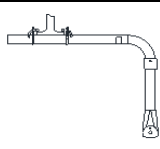



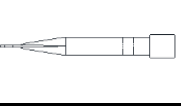

HIGH PERFORMANCE AIR CIRCULATOR MACH 24 & 30

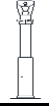





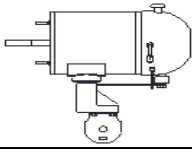
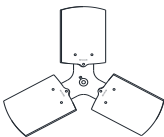
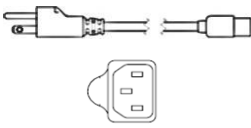
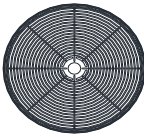
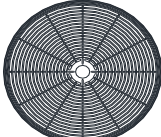
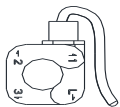
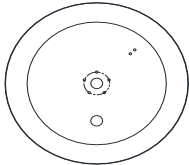

MOTOR	BLADE		CORD	SWITCH	
					
3900-11011-000 MACH24A MACH24P MACH24W MACH30A MACH30P MACH30W	1210-2014-000 MACH24A MACH24P MACH24W	1210-2026-000 MACH30A MACH30P MACH30W	1420-11004-000 MACH24A MACH24P MACH24W MACH30A MACH30P MACH30W	5216-2059-000 MACH24A MACH24P MACH24W MACH30A MACH30P MACH30W	
GUARD REAR		GUARD FRONT			
					
2504-2039-004 MACH24A MACH24P MACH24W	2504-2037-004 MACH30A MACH30P MACH30W	2504-2040-004 MACH24A MACH24P MACH24W	2504-2038-004 MACH30A MACH30P MACH30W		
MOUNTING KIT* (COMPLETE ASY)		ACCESSORY KIT			
					
2430PBA MACH24P MACH30P	2430WGA MACH24W MACH30W	002-057 MACH24P MACH30P	3277 MACH24W MACH30W		
WALL MT BASE	WALL MT ARM	WALL MT KIT	PEDESTAL BASE	COLUMN	
					
045-131-B MACH24W MACH30W	1215-2233-000 MACH24W MACH30W	991-473 MACH24W MACH30W	1208-2013-001 MACH24P MACH30P	1446-0003-002 MACH24P MACH30P	
PLUG CONFIGURATION ABOVE IS ONLY TYPE AVAILABLE, IF MOTORS USE DIFFERENT CONFIGURATION THE MOTOR MUST BE REPLACED AS WELL.					

INDUSTRIAL AIR CIRCULATOR 24ACH & 30ACH				
MOTOR	BLADE		CORD	SWITCH
				
3900-11009-000 24ACHA 24ACHP 24ACHW 30ACHA 30ACHP 30ACHW	1210-2014-000 24ACHA 24ACHP 24ACHW	1210-2026-000 30ACHA 30ACHP 30ACHW	1420-11004-000 24ACHA 24ACHP 24ACHW 30ACHA 30ACHP 30ACHW	5216-2059-000 24ACHA 24ACHP 24ACHW 30ACHA 30ACHP 30ACHW
GUARD REAR		GUARD FRONT		
				
2504-2039-004 24ACHA 24ACHP 24ACHW	2504-2037-004 30ACHA 30ACHP 30ACHW	2504-2040-004 24ACHA 24ACHP 24ACHW	2504-2038-004 30ACHA 30ACHP 30ACHW	
MOUNTING KIT* (COMPLETE ASY)		ACCESSORY KIT		
				
2430PBA 24ACHP 30ACHP	2430WGA 24ACHW 30ACHW	002-057 24ACHP 30ACHP	3277 24ACHW 30ACHW	
WALL MT BASE	WALL MT ARM	WALL MT KIT	PEDESTAL BASE	
				COLUMN
045-131-B 24ACHW 30ACHW	1215-2233-000 24ACHW 30ACHW	991-473 24ACHW 30ACHW	1208-2013-001 24ACHP 30ACHP	1446-0003-002 24ACHP 30ACHP
PLUG CONFIGURATION ABOVE IS ONLY TYPE AVAILABLE, IF MOTORS USE DIFFERENT CONFIGURATION THE MOTOR MUST BE REPLACED AS WELL.				

EXTRA HEAVY DUTY AIR CIRCULATOR 24HDH 30HDH & 36HDH SERIES

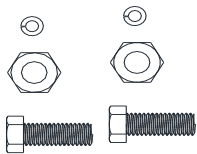
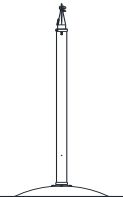
MOTOR		BLADE			
					
3900-11013-000 24HDHA 24HDHC 24HDHI 24HDHP 24HDHW 30HDHA 30HDHC 30HDHI 30HDHP 30HDHW	3900-11030-000 30HDHB 30HDHCB 30HDHIB 30HDHPB 30HDHWB 36HDHA 36HDHB	1210-2035-000 24HDHA 24HDHC 24HDHI 24HDHP 24HDHW 1210-2026-001 30HDHA 30HDHC 30HDHI 30HDHP 30HDHW	1210-2037-000 36HDHA 36HDHB LCCLIN3016BL 30HDHB 30HDHCB 30HDHIB 30HDHPB 30HDHWB		
GUARD REAR		GUARD FRONT			
					
2504-2039-004 24HDHA 24HDHC 24HDHI 24HDHP 24HDHW	2504-2037-004 30HDHA 30HDHB 30HDHC 30HDHCB 30HDHI 30HDHIB	2504-2040-004 24HDHA 24HDHC 24HDHI 24HDHP 24HDHW	2504-2038-004 30HDHA 30HDHB 30HDHC 30HDHCB 30HDHI 30HDHIB	PULL CHAIN SWITCH	
2504-2048-004 36HDHA 36HDHB	30HDHCB 30HDHIB 30HDHP 30HDHPB 30HDHW 30HDHWB	2504-2049-004 36HDHA 36HDHB	30HDHCB 30HDHIB 30HDHP 30HDHPB 30HDHW 30HDHWB	 5216-2059-000 ALL MODELS	
MOUNTING KIT* (COMPLETE ASY)				CORD	PARTS KIT
					
2430C 24HDHC 30HDHC 30HDHCB	2430I 24HDHI 30HDHI 30HDHIB	2430PBA 24HDHP 30HDHP 30HDHPB	2430WGA 24HDHW 30HDHW 30HDHWB	1420-11004-000 WITH 3900-11030-000 MOTORS ONLY	1016-0068-000 ALL MODELS
I-BEAM CLAMPS	I-BEAM BENT	I-BEAM 13"	CEILING MOUNT	PEDESTAL BASE	COLUMN
					
LPIBC 24HDHI 30HDHI 30HDHIB	LIB002 24HDHI 30HDHI 30HDHIB	LIB003 24HDHC 24HDHI 30HDHC 30HDHCB 30HDHI 30HDHIB	L2430CM 24HDHC 30HDHC 30HDHCB	1208-2013-001 24HDHP 30HDHP 30HDHPB	1446-0003-002 24HDHP 30HDHP 30HDHPB
WALL MT BASE	WALL MT ARM	WALL MT KIT	PULLCHAIN STRING	ACCESSORY KIT	
					
045-131-B 24HDHW 30HDHW 30HDHWB	1215-2233-000 24HDHW 30HDHW 30HDHWB	991-473 24HDHW 30HDHW 30HDHWB	3378 24HDHC 24HDHI 24HDHW 30HDHC 30HDHCB 30HDHI 30HDHIB 30HDHW 30HDHWB	3277 24HDHC 24HDHI 24HDHW 30HDHC 30HDHCB 30HDHI 30HDHIB 30HDHW 30HDHWB	002-057 24HDHP 30HDHP 30HDHPB
<p>PLUG CONFIGURATION ABOVE IS ONLY TYPE AVAILABLE, IF MOTORS USE DIFFERENT CONFIGURATION THE MOTOR MUST BE REPLACED AS WELL.</p>					

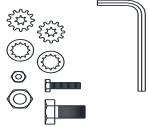
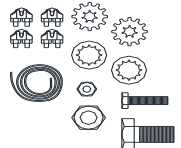
INDUSTRIAL OSCILLATING AIR CIRCULATOR 24ACHO & 30ACHO



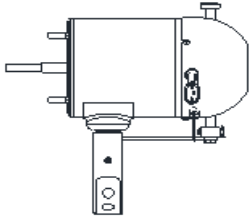
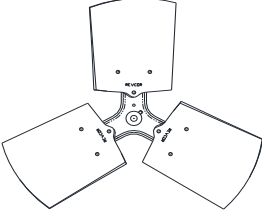
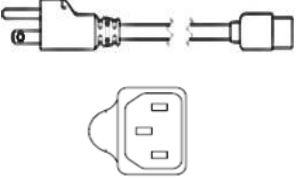
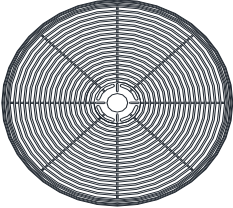
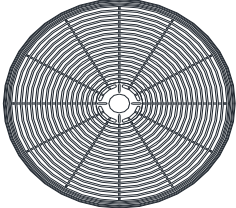
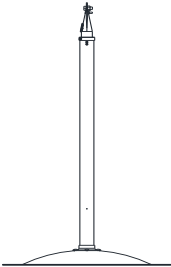
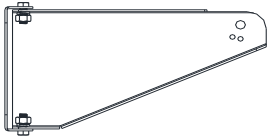

MOTOR	BLADE		CORD	HARDWARE KIT
				PICTURE NOT AVAILABLE
3900-11010-000 24ACHOA 24ACPOUA 24ACWOUA 30ACHOA 30ACPOUA 30ACWOUA	1210-2014-000 24ACHOA 24ACPOUA 24ACWOUA	1210-2026-000 30ACHOA 30ACPOUA 30ACWOUA	1420-11004-000 24ACHOA 24ACPOUA 24ACWOUA 30ACHOA 30ACPOUA 30ACWOUA	4092 24ACPOUA 24ACWOUA 30ACPOUA 30ACWOUA
GUARD REAR		GUARD FRONT		SWITCH
				
2504-2039-004 24ACHOA 24ACPOUA 24ACWOUA	2504-2037-004 30ACHOA 30ACPOUA 30ACWOUA	2504-2040-004 24ACHOA 24ACPOUA 24ACWOUA	2504-2038-004 30ACHOA 30ACPOUA 30ACWOUA	5216-2059-000 24ACHOA 24ACPOUA 24ACWOUA 30ACHOA 30ACPOUA 30ACWOUA
PEDESTAL BASE	COLUMN	WALL MT BASE	WALL MT ARM	WALL MT KIT
				
1208-2013-001 24ACPOUA 30ACPOUA	1446-0003-002 24ACPOUA 30ACPOUA	045-131-B 24ACWOUA 30ACWOUA	1215-2233-000 24ACWOUA 30ACWOUA	991-473 24ACWOUA 30ACWOUA
MOUNTING BKT (COMPLETE)		ACCESSORY KIT		
				
2430PBA 24ACPOUA 30ACPOUA	2430WGA 24ACWOUA 30ACWOUA	002-057 24ACPOUA 30ACPOUA	3277 24ACWOUA 30ACWOUA	
PLUG CONFIGURATION ABOVE IS ONLY TYPE AVAILABLE, IF MOTORS USE DIFFERENT CONFIGURATION THE MOTOR MUST BE REPLACED AS WELL.				

LCHHD HEAVY DUTY OSSILLATING AIR CIRCULATOR

MOTOR	BLADE		CORD
			
3900-11012-000 LCHHD240 LCHHD300	1210-2014-000 LCHHD240	1210-2026-000 LCHHD300	1420-11004-000 LCHHD240 LCHHD300
GUARD REAR		GUARD FRONT	
			
2504-2039-004 LCHHD240	2504-2037-004 LCHHD300	2504-2040-004 LCHHD240	2504-2038-004 LCHHD300
MOUNTING KIT (COMPLETE)		PARTS KIT	
		PICTURE NOT AVAILABLE	
2430PBA LCHHD247 LCHHD307	2430WGA LCHHD247 LCHHD307	3303-2015-000 LCHHD240 LCHHD300	
PLUG CONFIGURATION ABOVE IS ONLY TYPE AVAILABLE, IF MOTORS USE DIFFERENT CONFIGURATION THE MOTOR MUST BE REPLACED AS WELL.			

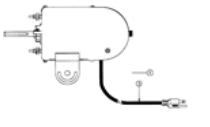
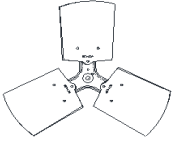
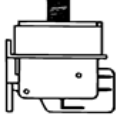

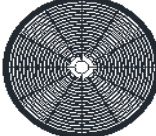

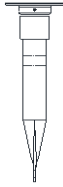
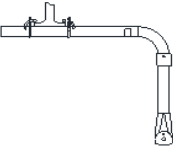
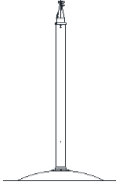

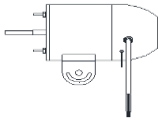
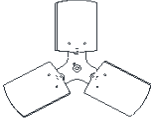

LCHWD SPECIALTY WASH DOWN CIRCULATOR

MOTOR	BLADE		SWITCH	SWITCH BULB
				
3900-2063-000 LCHWD24 LCHWD24WB LCHWD30 LCHWD30WB LCHWD30CM LCHWD30LIB LCHWD30P	LCCLIN2419BL LCHWD24 LCHWD24WB	LCCLIN30BL LCHWD30 LCHWD30WB LCHWD30CM LCHWD30LIB LCHWD30P	LP054 LCHWD24 LCHWD24WB LCHWD30 LCHWD30WB LCHWD30CM LCHWD30LIB LCHWD30P	LP055 LCHWD24 LCHWD24WB LCHWD30 LCHWD30WB LCHWD30CM LCHWD30LIB LCHWD30P
GUARD REAR		GUARD FRONT		
				
2504-2039-003 LCHWD24 LCHWD24WB	2504-2037-003 LCHWD30 LCHWD30WB LCHWD30CM LCHWD30LIB LCHWD30P	2504-2040-003 LCHWD24 LCHWD24WB	2504-2038-003 LCHWD30 LCHWD30WB LCHWD30CM LCHWD30LIB LCHWD30P	
MOUNTING KIT (COMPLETE)				
				
LWBWD LCHWD24WB LCHWD30WB	LCMWD LCHWD30CM	LIBWD LCHWD30LIB	LFPCBWD LCHWD30P	

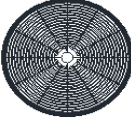
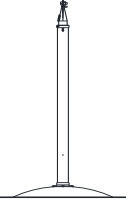

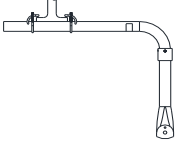



LCHHD SPECIALTY 277V AIR CIRCULATOR



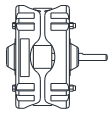
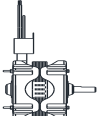
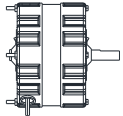
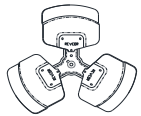
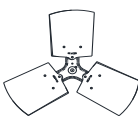
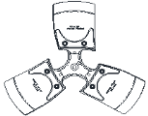
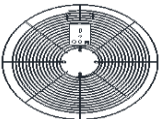

MOTOR		BLADE		CORD
				
3900-2078-000 LCHHD247 LCHHD307		1210-2014-000 LCHHD247		1210-2026-000 LCHHD307
1420-2013-500 LCHHD247 LCHHD307				
GUARD REAR		GUARD FRONT		
				
2504-2039-004 LCHHD247		2504-2037-004 LCHHD307		2504-2040-004 LCHHD247
2504-2038-004 LCHHD307				
MOUNTING KIT (COMPLETE)				
				
				
2430PBA LCHHD247 LCHHD307		2430C LCHHD247 LCHHD307		2430I LCHHD247 LCHHD307
2430WGA LCHHD247 LCHHD307				

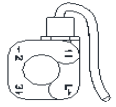

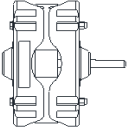
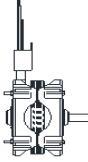
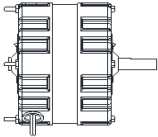
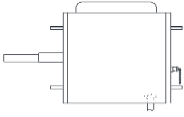
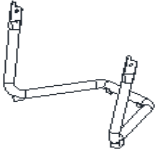
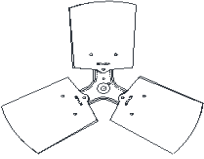
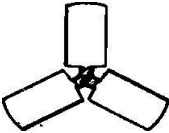

B-SERIES UTILITY CIRCULATORS

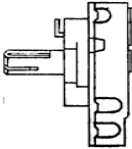
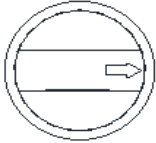
MOTOR			BLADE		
					
517-116-BL B12P B12PA 517-117-BL B14 B14A	517-084-BL B18 B18A B20P B20PA	517-103 B18TE B18TEA	1210-2027-000 B12PA	1210-2023-000 B14 B14A 1210-2013-000 B18 B18A B18TE B18TEA	1210-2036-000 B20PA
GUARD REAR			GUARD FRONT		
					
372-050-AG B12P B12PA 372-074-AG B14A	372-054-AG B18 B18A B18TE B18TEA	372-056-AG B20P B20PA	372-065-AG B12P B12PA 372-066-AG B14 B14A	372-067-AG B18 B18A B18TE B18TEA 372-078-AG B20P B20PA	
YOKE			CORD	SWITCH	
					
3338 B12P B12PA 3339 B14 B14A	1363 B18 B18A B18TE B18TEA	4174 B20P B20PA	118 ALL MODELS	5216-2059-000 ALL MODELS	

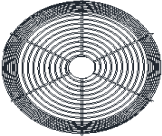
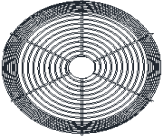
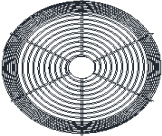



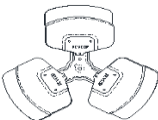
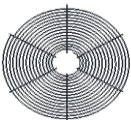
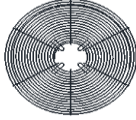

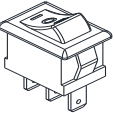
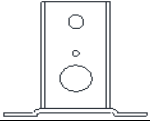

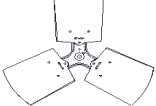
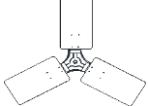
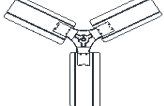
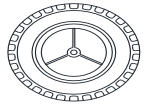
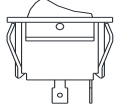

I-SERIES INDUSTRIAL FLOOR CIRCULATOR

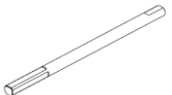
I-SERIES INDUSTRIAL FLOOR CIRCULATOR					
MOTOR				STAND	
			PICTURE NOT AVAILABLE		
517-116-BL I12	517-084-BL I18 I20 I20CA	517-103 I18TE	517-089 I24	1010MB I30	991-629-C I18 I18TE
BLADE			CORD	SWITCH	KNOB
	PICTURE NOT AVAILABLE				
1210-2013-000 I18 I18TE	991-284 I20 I20CA	1210-2026-000 I30	118 I12 I18 I18TE I20 I20CA	16000 I12 I18 I18TE I20 I20CA	441-229-B I12 I18 I18TE I20 I20CA I24
GUARD REAR		GUARD FRONT			
					
372-054-AG I18 I18TE	372-065-AG I12	372-067-AG I18 I18TE	372-078-AG I20 I20CA		

NAVY FAN N12

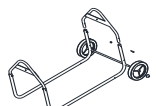

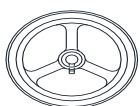
MOTOR	BLADE	GUARD FRT	GUARD BCK
			
3900-11027-000 N12A	1210-2027-001 N12 N12A	372-045-OP N12 N12A	372-046-OP N12 N12A
SWITCH	BASE ASY		
			
4425 N12 N12A	991-124-OP N12 N12A		

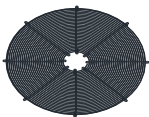
IDF SERIES DRUM BLOWER

IDF SERIES DRUM BLOWER				
MOTOR	BLADE			
				
3900-11023-000 ALL MODELS	1210-2020-001 IDF36B IDF36BC	1210-2025-001 IDF42B IDF42BC	1016-0044-001 IDF48B IDF48BC	
WHEEL (2REQ)	ROCKER SW.	BELT	PULLY MOTOR	
				
869-007 ALL MODELS	5216-2052-000 ALL MODELS	9707-8055 ALL MODELS	2594 ALL MODELS	
SHAFT	CORD	AXLE PILLOW BLK (2REQ)	CAPACITOR	
				
8856-8014 ALL MODELS	1420-2023-000 ALL MODELS	1209-11001-000 ALL MODELS	6100-8026 ALL MODELS	
CART ASY	WHEEL AXLE	PULLEY FAN	HANDLE	GUARD (2REQ)
				
1016-10724-001 IDF36BC	1017-0003-000 IDF36B	612-015 ALL MODELS	3232 IDF36B	2794-AG IDF36B
1016-10724-002 IDF42BC	IDF42B IDF48B		IDF42B IDF48B	3293-AG IDF42B
1016-10724-003 IDF48BC	1017-0003-002 IDF36BC IDF42BC IDF48BC			3294-AG IDF48B IDF48BC

INDUSTRIAL CEILING FANS

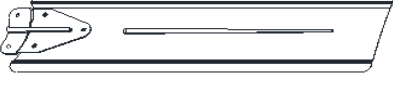

BLADE (SET)

						
9B3620-1 36201	9B4820-3 48203	9B5600-1 56001	9B6000-1 60001	9B5630-1R 56301RDP		
9B4820-1 48201 48207	9B5600-1LC 56001LC 56101 56111	56002	9B6001-1 60011			
9B4820-1B 48201B		9B5601-1 56011	9B6011-1 60101 60111			
		9B5600-1B 56001B	9B5620-1 56201			

DOWNROD 24"

DOWNROD 8"

MOTOR

		
---	---	---

9D24BW 36201 48201 56001LC 56001 56002 56003 56007 56301RDP 48203 48207 60001 56201	9D24BBLK 48201B 56001B 9D24BB 56011 60011 9D12TW 56101 56111 60101 60111	9D08 36201 48201 56001LC 56003 48203 9D08BBLK 48201B	9M3620-1-A 36201 9M4820-1-A 48201 9M4820-1B-A 48201B 9M4820-3-A 48203 9M5600-7-A 48207 6011-1U 60101 60111	9M5600-1LC-A 56001LC 9M5600-1-A 56001 9M5600-1B-A 56001B 9M5600-4-A 56002 9M5600-3-A 56003 9M5600-7-A 56007	9M5601-1-A 56011 5611-1U 56101 56111 9M5630-1R-A 56301RDP 9M6000-1-A 60001 9M6001-1-A 60011 9M5620-1-A 56201
--	---	---	--	--	--

RUBBER ROLLER

J HOOK KIT

BLADE SCREWS (6 REQ)

BLADE PADS (3 REQ)

REVERSIBLE TOGGLE

REVERSING SW. PLATE



					
9F2900-04A ALL MODELS	9F2900-01 ALL MODELS	9F2900-20A ALL MODELS	9F2900-19A ALL MODELS	9F2GX54-73 56301RDP	9FP005 56301RDP

CANOPY UPPER

CANOPY LOWER



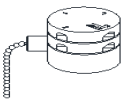



	
---	---

9F2900-07A 36201 48201 56001LC 56001 56002 56003 56007 56301RDP 48203 48207 60001 56201	9F2900-07AB 48201B 56001B 9FP029 56011 60011 3100039A 56101 56111 60101 60111	9F2900-08A 36201 48201 56001LC 56001 56002 56003 56007	9F2900-08B 60001 60101 60111 56301RDP 48203 48207 56101 56111	9F2900-08AB 48201B 56001B 9FP030 56011 60011
--	--	--	--	---

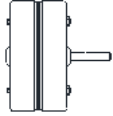
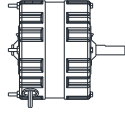
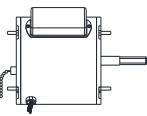
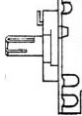
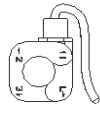
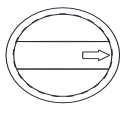

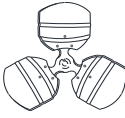
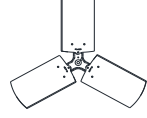
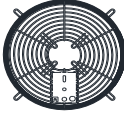
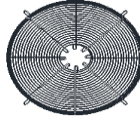
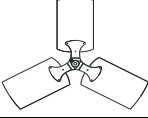

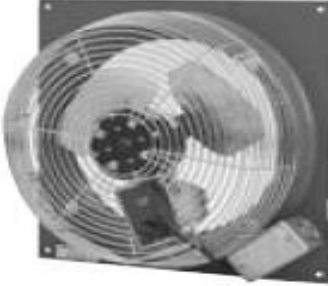

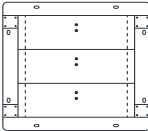
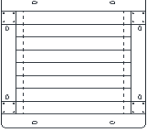
3-SPEED PULL CHAIN SW.	PULL CHAIN STRING	OUTDOOR KIT
		PICTURE NOT AVAILABLE
9F2900-26 48203 56003	3378 48203 56003	99992 56101 60101



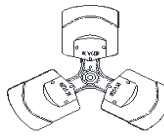
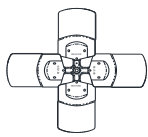
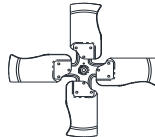
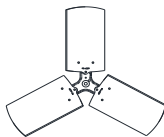
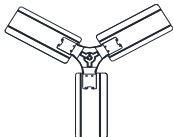
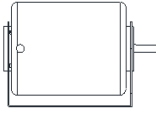
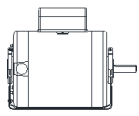

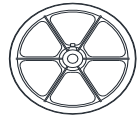

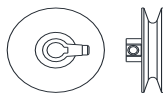

LPE SERIES

MOTOR			SWITCH		KNOB
					
3808 LPE12 LPE12A LPE12S LPE12SA LPE12V LPE12VA	517-103 LPE16 LPE16A LPE16S LPE16SA LPE16V LPE16VA	3900-2040-000 LPE22V LPE22VA LPE24 LPE24A LPE24S LPE24SA LPE30 LPE30A LPE30S LPE30SA	16000 LPE12 LPE12A LPE12S LPE12SA LPE12V LPE12VA LPE16 LPE16A LPE16S LPE16SA LPE16V LPE16VA	5216-2059-000 LPE22V LPE22VA LPE24 LPE24A LPE24S LPE24SA LPE30 LPE30A LPE30S LPE30SA	441-229-B LPE12 LPE12A LPE12S LPE12SA LPE12V LPE12VA LPE16 LPE16A LPE16S LPE16SA LPE16V LPE16VA
BLADE ASY			GUARD		
					
1210-2027-000 LPE12A LPE12SA LPE12VA	490013001 LPE16A	1210-2014-000 LPE24 LPE24A LPE24S LPE24SA	372-082-AG LPE12 LPE12A LPE12S LPE12SA	372-086-AG LPE16 LPE16A LPE16S LPE16SA	372-087-AG LPE24 LPE24A LPE24S LPE24SA
		1210-2026-000 LPE30 LPE30A LPE30S LPE30SA	372-085-AG LPE12V LPE12VA	372-084-AG LPE16V LPE16VA	372-088-AG LPE30 LPE30A LPE30S LPE30SA
1210-2029-000 LPE22V LPE22VA	1210-2033-000 LPE16SA LPE16VA				2504-2036-001 LPE22VA
SHUTTER		 <p align="center">LPEV</p>  <p align="center">LPES</p>			
					
2644 LPE12S LPE12SA	3538 LPE30S LPE30SA				
2649 LPE16S LPE16SA					
3534 LPE24S LPE24SA					

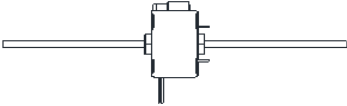
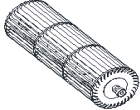
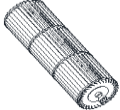
BE SERIES COMMERCIAL BELT DRIVE EXHAUST FAN

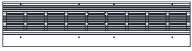
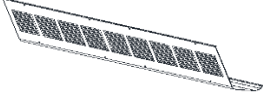
BLADE				
				
8528-8147 BE24	8528-8148 BE30	8528-8149 BE36	1210-2025-001 BE42	1016-0044-001 BE48
MOTOR		SHAFT-ARBOR	BELT	
				
3900-2068-000 BE24 BE30 BE36 BE42	517-083 BE48	5217-2006-000 BE24 BE30 BE36 BE42	9707-8053 BE24	9707-8055 BE30
			1230-0003-000 BE36	4280 BE42
PULLEY FAN	PULLEY MOTOR		BEARING (2 REQ)	
				
4436 BE24	612-019 BE24	4434 BE30	8526-8006 BE24 BE30 BE36 BE42	
1064 BE30 BE36	4507-2009-000 BE36	2594 BE42 BE48		
1804 BE42 BE48				

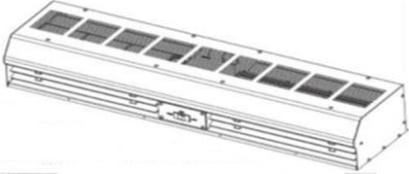

MLP LOW-PROFILE SERIES					
MOTOR		BLOWER WHEEL RIGHT		BLOWER WHEEL LEFT	
					
3900-2090-000 MLP36001115GA MLP3600115GR MLP36001115GRSS MLP42001110GA MLP42001110GR MLP42001110GRSS MLP48001108GA MLP48001108GR MLP48001108GRSS MLP60001108GA MLP60001108GR MLP60001108GRSS	3900-2093-001 MLP36001208GA MLP36001208GR MLP36001208GRSS MLP42001208GA MLP42001208GR MLP42001208GRSS MLP48001206GA MLP48001206GR MLP48001206GRSS MLP60001206GA MLP60001206GR MLP60001206GRSS	1225-2024-000 MLP36001115GA MLP3600115GR MLP36001115GRSS MLP36001208GA MLP36001208GR MLP36001208GRSS 1225-2024-001 MLP42001110GA MLP42001110GR MLP42001110GRSS MLP42001208GA MLP42001208GR MLP42001208GRSS	1225-2024-002 MLP48001108GA MLP48001108GR MLP48001108GRSS MLP48001206GA MLP48001206GR MLP48001206GRSS 1225-2024-003 MLP60001108GA MLP60001108GR MLP60001108GRSS MLP60001206GA MLP60001206GR MLP60001206GRSS	1225-2025-000 MLP36001115GA MLP3600115GR MLP36001115GRSS MLP36001208GA MLP36001208GR MLP36001208GRSS 1225-2025-001 MLP42001110GA MLP42001110GR MLP42001110GRSS MLP42001208GA MLP42001208GR MLP42001208GRSS	1225-2025-002 MLP48001108GA MLP48001108GR MLP48001108GRSS MLP48001206GA MLP48001206GR MLP48001206GRSS 1225-2025-003 MLP60001108GA MLP60001108GR MLP60001108GRSS MLP60001206GA MLP60001206GR MLP60001206GRSS
CORD		GRILLE			SWITCH
					
1420-2038-004 MLP36001115GA MLP3600115GR MLP36001115GRSS MLP42001110GA MLP42001110GR MLP42001110GRSS MLP48001108GA MLP48001108GR MLP48001108GRSS MLP60001108GA MLP60001108GR MLP60001108GRSS	1420-2044-001 MLP36001208GA MLP36001208GR MLP36001208GRSS MLP42001208GA MLP42001208GR MLP42001208GRSS MLP48001206GA MLP48001206GR MLP48001206GRSS MLP60001206GA MLP60001206GR MLP60001206GRSS	1809-2033-800 MLP36001115GA MLP36001208GA 1809-2033-801 MLP42001110GA MLP42001208GA 1809-2033-802 MLP48001108GA MLP48001206GA 1809-2033-803 MLP60001108GA MLP60001206GA	2501-2090-900 MLP3600115GR MLP36001208GR 2501-2090-901 MLP42001110GR MLP42001208GR 2501-2090-902 MLP48001108GR MLP48001206GR 2501-2090-903 MLP60001108GR MLP60001206GR	2501-2090-200 MLP36001115GRSS MLP36001208GRSS 2501-2090-201 MLP42001110GRSS MLP42001208GRSS 2501-2090-202 MLP48001108GRSS MLP48001206GRSS 2501-2090-203 MLP60001108GRSS MLP60001206GRSS	790-188 ALL MODELS
Low-Profile - Contemporary Series 		Low-Profile - Architectural Series 			

ENVIRONMENTAL SERIES AIR CURTAINS

MOTOR BLOWER ASY

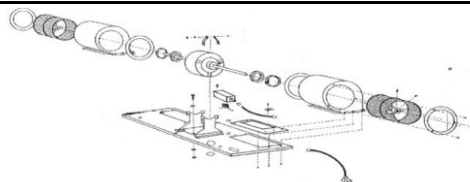

ACMB125	ACMB225	ACMB300		ACMB305	ACMB325	ACMB350	ACMB600	
E36001125	E36001225	E36001300	E84002300	E36001305	E36001325	E36001350	E36001675	
E38001125	E38001225	E36001375	E84002375	E36001405	E36001425	E36001450	E42001675	
E42001125	E42001225	E36001400	E84002400	E36001505	E36001525	E36001550	E60001675	
E48001125	E48001225	E36001475	E84002475	E38001305	E38001325	E38001350	E96002675	
E72002125	E60001225	E36001500	E84002500	E38001405	E38001425	E38001450	E10803675	
E76002125	E72002225	E36001575	E84002575	E38001505	E38001525	E38001550	ACMB650	
E84002125	E76002225	E38001300	E96002300	E42001305	E42001325	E42001350	E72002650	
E96002125	E84002225	E38001375	E96002375	E42001405	E42001425	E42001450	E10803650	
E10803125	E96002225	E38001400	E96002400	E42001505	E42001525	E42001550	ACMB125D	
E12003125	E10803225	E38001475	E96002475	E48001305	E48001325	E48001350	E60002125	
E13203125	E12003225	E38001500	E96002500	E48001405	E48001425	E48001450	ACMB150D	
E14403125	E13203225	E38001575	E96002575	E48001505	E48001525	E48001550	E60002150	
	E14403225	E42001300	E10803300	E60001305	E72002325	E72002350	ACMB225D	
ACMB150		E42001375	E10803375	E60001405	E72002425	E72002450	E60002225	
E36001150	ACMB250	E36001400	E10803400	E60001505	E72002525	E72002550	ACMB250D	
E38001150	E36001250	E42001400	E10803400	E72002305	E76002325	E76002350	E60002250	
E42001150	E38001250	E42001475	E10803475	E72002405	E76002425	E76002450	ACMB325D	
E48001150	E42001250	E42001475	E10803500	E72002405	E76002425	E76002450	E60002325	
E60001150	E48001250	E42001575	E10803575	E72002505	E76002525	E76002550	E60002425	
E72002150	E60001250	E48001300	E12003300	E76002305	E84002325	E84002350	E60002425	
E76002150	E72002250	E48001375	E12003375	E76002405	E84002425	E84002450	E60002525	
E84002150	E76002250	E48001400	E12003400	E76002505	E84002525	E84002550	ACMB350D	
E96002150	E84002250	E48001475	E12003475	E84002305	E84002325	E84002350	E96002350	
E10803150	E96002250	E48001500	E12003500	E84002405	E96002425	E96002450	E96002450	
E12002150	E10803250	E48001575	E12003575	E84002505	E96002525	E96002550	E60002350	
E12003150	E12003250	E60001300	E13203300	E96002305	E10803325	E10803350	E60002450	
E13203150	E13203250	E60001375	E13203375	E96002405	E10803425	E10803450	E60002550	
E14403150	E14403250	E60001400	E13203400	E96002505	E10803525	E10803550		
		E60001475	E13203475	E10803305	E12003325	E12003350		
ACMB175	ACMB275	E60001500	E13203500	E10803405	E12003425	E12003450		
E36001175	E36001275	E60001575	E13403575	E10803505	E12003525	E12003550		
E38001175	E38001275	E72002300	E14403300	E12003305	E13203325	E13203350		
E42001175	E42001275	E72002375	E14403375	E12003405	E13203425	E13203450		
E48001175	E48001275	E72002400	E14003400	E12003505	E13203525	E13403550		
E60001175	E60001275	E72002475	E14403475	E13203305	E14403325	E14403350		
E72002175	E72002275	E72002500	E14403500	E13203405	E14403425	E14403450		
E76002175	E76002275	E72002575	E14403575	E13203505	E14403525	E14403550		
E84002175	E84002275	E76002300		E14403305				
E96002175	E96002275	E76002375		E14403405				
E10803175	E10803275	E76002400		E14403505				
E12002175	E12003275	E76002475						
E12003175	E13203275	E76002500						
E13203175	E14403275	E76002575						
E14403175		E76002675						
		E76002750						
WIRE HARNESS	GRILLE KNURLED NUT	ROCKER SWITCH						
	PICTURE NOT AVAILABLE							
ACWS616	AP0002	C1220						
ALL MODELS	ALL MODELS	E36001125	E60001175	E84002275	E13203250			
		E36001150	E60001225	E96002125	E13203275			
		E36001175	E60001250	E96002150	E14403125			
		E36001225	E60001275	E96002175	E14403150			
		E36001250	E60002125	E96002225	E14403175			
		E36001275	E60002150	E96002250	E14403225			
CABINET ASY		E38001125	E60002225	E96002275	E14403250			
1016-0096-000	36"	E38001150	E60002250	E10803125	E14403275			
1016-0096-001	38"	E38001175	E72002125	E10803150				
1016-0096-002	42"	E38001225	E72002150	E10803175				
1016-0096-003	48"	E38001250	E72002175	E10803225				
1016-0096-004	60"	E38001275	E72002225	E10803250				
1016-0096-005	60" DUALY	E42001125	E72002250	E10803275				
		E42001150	E72002275	E12002150				
		E42001175	E76002125	E12002175				
		E42001225	E76002150	E12003125				
		E42001250	E76002175	E12003150				
		E42001275	E76002225	E12003175				
		E48001125	E76002250	E12003225				
GRILLE ASY		E48001150	E76002275	E12003250				
1016-0093-000	36"	E48001175	E84002125	E12003275				
1016-0093-001	38"	E48001225	E84002150	E13203125				
1016-0093-002	42"	E48001250	E84002175	E13203150				
1016-0093-003	48"	E48001275	E84002225	E13203175				
1016-0093-004	60"	E60001150	E84002250	E13203225				



NOTE

5TH DIGIT IN MODEL NUMBER DETERMINS MOTOR AND WIRE HARNESS QTY.

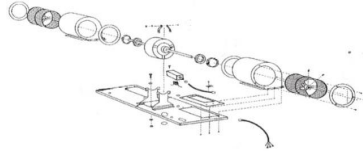

HIGH VELOCITY SERIES AIR CURTAINS

MOTOR BLOWER ASY





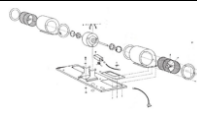

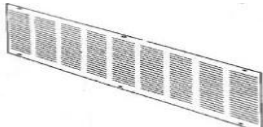
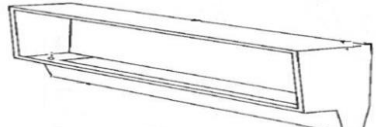

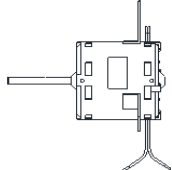
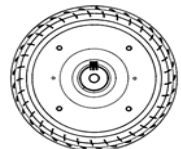
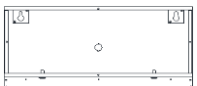

ACMB300		ACMB305		ACMB330									
EL36001300LI	EL76002500LI	EL36001305LI	EL76002505LI	EL36001330LI	EL76002530LI								
EL36001400LI	EL84002300LI	EL36001405LI	EL84002305LI	EL36001430LI	EL84002330LI								
EL36001500LI	EL84002400LI	EL36001505LI	EL84002405LI	EL36001530LI	EL84002430LI								
EL38001300LI	EL84002500LI	EL38001305LI	EL84002505LI	EL38001330LI	EL84002530LI								
EL38001400LI	EL96002300LI	EL38001405LI	EL96002305LI	EL38001430LI	EL96002330LI								
EL38001500LI	EL96002400LI	EL38001505LI	EL96002405LI	EL38001530LI	EL96002430LI								
EL42001300LI	EL96002500LI	EL42001305LI	EL96002505LI	EL42001330LI	EL96002530LI								
EL42001400LI	EL10803300LI	EL42001405LI	EL10803305LI	EL42001430LI	EL10803330LI								
EL42001500LI	EL10803400LI	EL42001505LI	EL10803405LI	EL42001530LI	EL10803430LI								
EL48001300LI	EL10803500LI	EL48001305LI	EL10803505LI	EL48001330LI	EL10803530LI								
EL48001400LI	EL12003300LI	EL48001405LI	EL12003305LI	EL48001430LI	EL12003330LI								
EL48001500LI	EL12003400LI	EL48001505LI	EL12003405LI	EL48001530LI	EL12003430LI								
EL60001300LI	EL12003500LI	EL60001305LI	EL12003505LI	EL60001330LI	EL12003530LI								
EL60001400LI	EL13203300LI	EL60001405LI	EL13203305LI	EL60001430LI	EL13203330LI								
EL60001500LI	EL13203400LI	EL60001505LI	EL13203405LI	EL60001530LI	EL13203430LI								
EL72002300LI	EL13203500LI	EL72002305LI	EL13203505LI	EL72002330LI	EL13203530LI								
EL72002400LI	EL14403300LI	EL72002405LI	EL14403305LI	EL72002430LI	EL14403330LI								
EL72002500LI	EL14403400LI	EL72002505LI	EL14403405LI	EL72002530LI	EL14403430LI								
EL76002300LI	EL14403500LI	EL76002305LI	EL14403505LI	EL76002330LI	EL14403530LI								
EL76002400LI		EL76002405LI		EL76002430LI									
ACMB600 EL36001600LI EL60001600LI EL72002600LI EL96002600LI EL10803600LI		ACMB605 EL96002605LI EL12003605LI		ACMB630 EL96002630LI EL10803630LI EL12003630LI EL14403630LI									
CABINET ASY		WIRE HARNESS											
<table style="width: 100%; border-collapse: collapse;"> <tr> <td style="width: 80%;">1016-0096-000</td> <td style="width: 20%;">36"</td> </tr> <tr> <td>1016-0096-001</td> <td>38"</td> </tr> <tr> <td>1016-0096-002</td> <td>42"</td> </tr> <tr> <td>1016-0096-003</td> <td>48"</td> </tr> <tr> <td>1016-0096-004</td> <td>60"</td> </tr> </table>		1016-0096-000	36"			1016-0096-001	38"	1016-0096-002	42"	1016-0096-003	48"	1016-0096-004	60"
1016-0096-000	36"												
1016-0096-001	38"												
1016-0096-002	42"												
1016-0096-003	48"												
1016-0096-004	60"												
GRILLE ASY		NOTE		5TH DIGIT IN MODEL NUMBER DETERMINS MOTOR AND WIRE HARNESS QTY.									
		<table style="width: 100%; border-collapse: collapse;"> <tr> <td style="width: 80%;">1016-0093-000</td> <td style="width: 20%;">36"</td> </tr> <tr> <td>1016-0093-001</td> <td>38"</td> </tr> <tr> <td>1016-0093-002</td> <td>42"</td> </tr> <tr> <td>1016-0093-003</td> <td>48"</td> </tr> <tr> <td>1016-0093-004</td> <td>60"</td> </tr> </table>				1016-0093-000	36"	1016-0093-001	38"	1016-0093-002	42"	1016-0093-003	48"
1016-0093-000	36"												
1016-0093-001	38"												
1016-0093-002	42"												
1016-0093-003	48"												
1016-0093-004	60"												

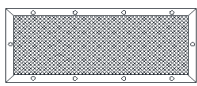
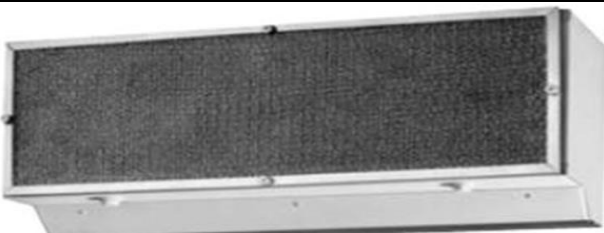
SINGLE PHASE ENVIRONMENTAL SERIES ELECTRICALLY HEATED

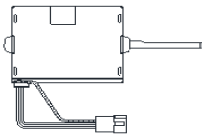
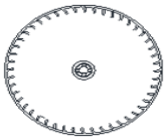

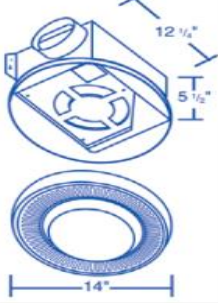

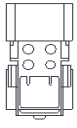
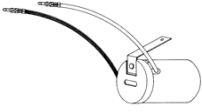
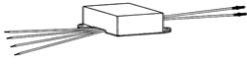

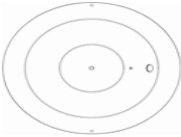
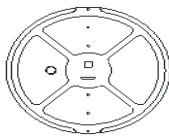
MOTOR BLOWER ASY	ELEMENT		THERMOSTAT	CABINET ASY	
	PICTURE NOT AVAILABLE				
ACMB125 ALL MODELS	APHE06240-1 E36061125H E42061125H E48061125H	APHE09240-1 E36091125H E42091125H E48091125H	T8775C1005 ALL MODELS		
GRILLE ASY			CABINET ASY		
					
1016-0093-000 E36061125H E36091125H	1016-0093-002 E42061125H E42091125H	1016-0093-003 E48061125H E48091125H	1016-0096-000 E36061125H E36091125H	1016-0096-002 E42061125H E42091125H	1016-0096-003 E48061125H E48091125H

24" DRIVE-THRU WINDOW UNIT

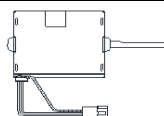
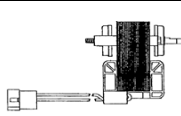

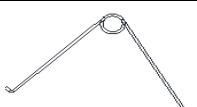

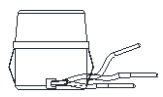
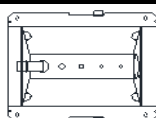

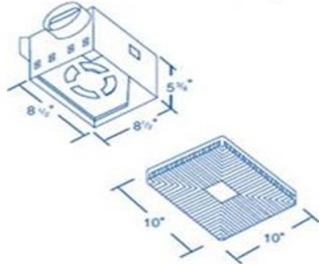
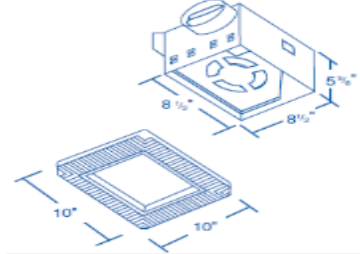





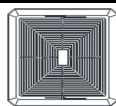

MOTOR (2 REQ)	IMPELLER (2 REQ)	CABINET	GRILLE	FILTER
				
3900-2069-000 E24001115F E24001115FG E24001115FHW E24001115G	8710-8022 E24001115F E24001115FG E24001115FHW E24001115G	1016-0109-000 E24001115F E24001115FG E24001115FHW E24001115G	2501-2066-000 E24001115F E24001115FG E24001115FHW E24001115G	2010-7009-028 E24001115F E24001115FHW 2010-7009-029 E24001115FG
				



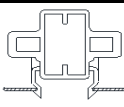
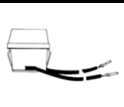

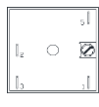
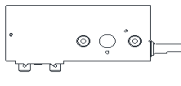
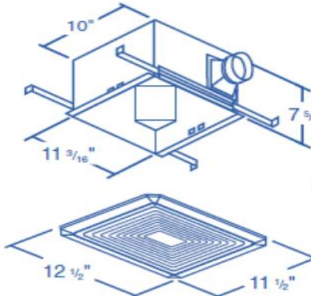

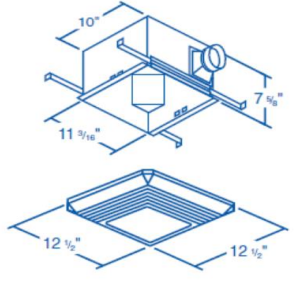

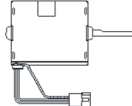
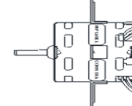
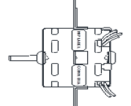

1001 SERIES				
MOTOR	IMPELLER	GRILLE		LENS
				
7163-9763 1001 1001F 1001BR	8710-8023 1001 1001F 1001BR	357-114-W 1001 1001F	357-114-OP 1001BR	460-011-W 1001 1001F 1001BR
LAMP HOLDER			BALLAST ASY	
				
3519-11005-000 1001	8695-8098 1001F	8695-8101 1001BR	6104-8020 1001F	
DUCT ADAPTER	REFLECTOR ASY		GRILLE SPRING (2 REQ)	
				
991-613 1001 1001F 1001BR	8826-8044 1001 1001BR	630-063 1001F	733-218 1001 1001F 1001BR	

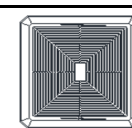
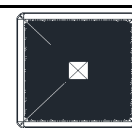
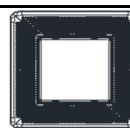
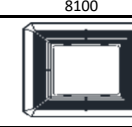
6000 SERIES

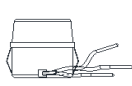
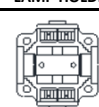
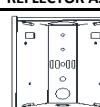
MOTOR				GRILLE	
					
7163-9763 6100 6100L 6100RL	7173-0174 6080 6080L 6080RL	8767-8238 6060 6060L 6060RL	991-688 6060 6080 6100	991-689 6060L 6080L 6100L	1016-0077-000 6060RL 6080RL 6100RL
IMPELLER		GRILLE SPRING (2 REQ)		DUCT ADAPTER	
					
8710-8021 6060 6060L 6060RL	8710-8023 6080 6080L 6080RL 6100 6100L 6100RL	733-218 6060 6060L 6060RL 6080 6080L		991-613 6060 6060L 6060RL 6080 6080L	
6080RL 6100		6100L 6100RL		6100L 6100RL	
LENS		LAMP HOLDER	REFLECTOR ASY		
					
8738-8017 6060L 6080L 6100L	3508-2003-000 6060RL 6080RL 6100RL	3519-0004-000 6060L 6060RL 6080L 6080RL 6100L 6100RL	991-591 6060L 6060RL 6080L 6080RL 6100L 6100RL		
  					

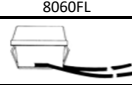



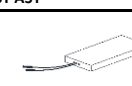

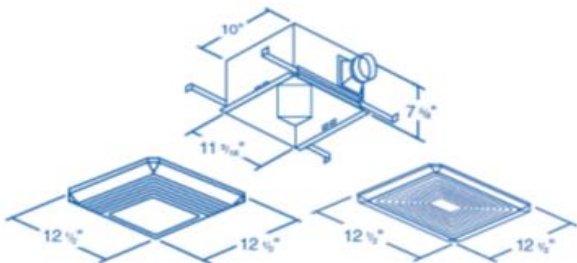

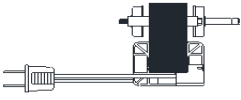
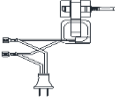

7100 SERIES

MOTOR		IMPELLER		GRILLE		GRILLE SPRINGS (2 REQ)		
								
GM7100 7100 7100A 7100FL 7100FLH 7100H 7100HA 7100L 7100LA 7100LH	GM7150 7150 7150A 7150FL 7150FLH 7150H 7150HA 7150L 7150LA 7150LH	8710-8017 7100 7100A 7100FL 7100FLH 7100H 7100HA 7100L 7100LA 7100LH		7150 7150A 7150FL 7150FLH 7150H 7150HA 7150L 7150LA 7150LH	991-611-W 7100 7100A 7100H 7100HA 7150 7150HA	991-608-W 7100FL 7100FLH 7100L 7100LA 7100LH 7150FL 7150FLH 7150H 7150L 7150LA 7150LH	733-218 ALL MODELS	
DUCT ADAPTER			LENS		LAMP HOLDER			
								
1016-0091-000 7100A 7100LA 7150A 7150LA		991-613 7100 7100FL 7100FLH 7100H 7100HA 7100L 7100LH		7150 7150FL 7150FLH 7150H 7150HA 7150L 7150LH	8738-8017 7100FL 7100FLH 7100L 7100LH 7150FL 7150FLH 7150L 7150LH	3508-2003-000 7100LA 7150LA	8695-8097 7100FL 7100FLH 7150FL 7150FLH	8504-8476 7100L 7100LA 7100LH 7150L 7150LA 7150LH
REFLECTOR ASY		BALLAST ASY		TIMER	HUMIDISTAT	NOTES		
						GM7100 AND GM7150 MOTOR/BLOWER ASSY INCLUDES IMPELLER AND MOTOR BRACKET		
8826-8040 7100L 7100LA 7100LH 7150L 7150LA 7150LH	5007-2023-000 7100FL 7100FLH 7150FL 7150FLH	1228-2002-000 7100FL 7100FLH 7150FL 7150FLH	1414-2031-000 7100FLH 7100HA 7150FLH 7150HA	1414-2032-000 7100FLH 7100HA 7150FLH 7150HA				
								

8000 SERIES					
MOTOR					
					
3900-2066-000 8090 8090A 8090L 8090LA	3900-2091-000 8060ES 8060ESA 8060FL 8060FLA 8060FLE	8100ES 8100ESA 8100ESH 8100ESHA 8100FL	8100FLA 8100FLE 8100FLH 8100FLHA 8100FLHE	3900-2092-000 8080ES 8080FL 8080FLA 8080FLE 8140A	8140ES 8140EAS 8140FL 8140FLA 8140FLE 8140LA
CAPACITOR			GRILLE		
					
1432-2007-000 8060ES 8060ESA 8060FL 8060FLA 8060FLE 8080ES 8080FL 8080FLA 8080FLE			8100FLHE 8140A 8140ES 8140EAS 8140FL 8140FLA 8140FLE 8140LA	991-611-W 8090 8100  991-608-W 8090L 8100L	1016-0137-000 8060ES 8060ESA 8080ES 8090A 8100A 8100ES 8100ESA 8100ESH 8100ESHA 8140A 8140ES 8140EAS
1016-0136-000 8060FL 8060FLA 8060FLE 8080FL 8080FLA 8080FLE 8090LA 8100FL 8100FLA 8100FLE 8100FLH 8100FLHA			8100FLHE 8100LA 8140FL 8140FLA 8140FLE 8140LA		
LENS		LAMP HOLDER		REFLECTOR ASY	TIMER
					
8738-8017 8060FL 8060FLA 8060FLE 8080FL 8080FLA 8080FLE 8090L 8090LA 8100FL 8100FLA		8100FLE 8100FLH 8100FLHA 8100FLHE 8100L 8100LA 8140FL 8140FLA 8140LA	3519-0004-000 8060FL  8504-8476 8090LA 8100LA	3519-11001-000 8060FLA 8060FLE 8080FLA 8080FLE 8100FLA 8100FLE 8100FLHA 8100FLHE 8140FLA 8140FLE 8140LA	8695-8097 8080FL 8100FL 8100FLH 8140FL
				8826-8040 8060FL 8090L 8090LA 8100L 8100LA 5007-2023-000 8080FL 8100FL 8100FLH 8140FL	1414-2031-000 8100ESH 8100ESHA 8100FLH 8100FLHA 8100FLHE
HUMIDISTAT	GRILLE SPRING (2 REQ)	DUCT ADAPTER	IMPELLER	BALLAST ASY	NOTES
					GM7100 IS MOTOR/BLOWER ASSY INCLUDES IMPELLER AND MOTOR BRACKET
1414-2032-000 8100ESH 8100ESHA 8100FLH 8100FLHA 8100FLHE	733-218 ALL MODELS	1016-0091-000 ALL MODELS	8710-8017 ALL MODELS	1228-2002-000 8060FL 8060FLA 8060FLE 8080FL 8080FLA 8080FLE 8100FL 8100FLH 8140FL	
				1016-11056-000 8100FLA 8100FLE 8100FLHA 8100FLHE 8140FLA 8140FLE 8140LA	

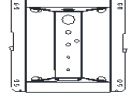



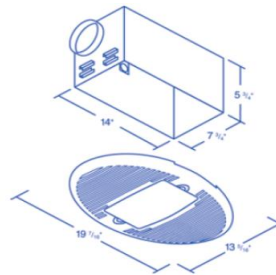

COMBINATION FANS MM698 & MM728NL

MOTOR (EXHAUST)		MOTOR (HEAT)	FAN	IMPELLER	DUCT ADAPTER	
						
3900-2049-000 MM728 MM728NL	8767-8130 MM698 MM698A MM698F MM698AF MM698WC MM698WCA	3900-2076-000 MM698 MM698A MM698F MM698AF MM698WC MM698WCA MM728 MM728NL	8528-8052 MM698 MM698A MM698F MM698AF MM698WC MM698WCA MM728 MM728NL	8710-8016 MM698 MM698A MM698F MM698AF MM698WC MM698WCA	313-076 MM728 MM728NL	991-614 MM698 MM698A MM698F MM698AF MM698WC MM698WCA MM728 MM728NL
GRILLE		LENS	REFLECTOR ASY			ELEMENT
						
1016-0080-000 MM698 MM698A MM698WC MM698WCA MM728 MM728NL	1016-0082-000 MM698F MM698AF	3508-2002-000 MM698 MM698A MM698F MM698AF MM698WC MM698WCA MM728 MM728NL	630-065 MM698 MM698A MM698WC MM698WCA MM728	630-068 MM698F MM698AF	5007-2024-000 MM728NL	991-497 MM698 MM698A MM698F MM698AF MM698WC MM698WCA MM728 MM728NL
LAMP HOLDER			WALL SWITCH	BALLAST ASY		
						
8695-8097 MM698F MM698AF	8504-8476 MM728NL	398-051 MM698 MM698A MM698WC MM698WCA MM728	8587-0003A MM698WC MM698WCA	8587-8229 MM728 MM728NL	1228-2002-000 MM698F MM698AF	

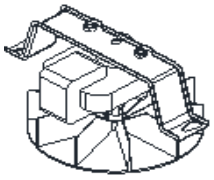
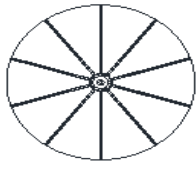
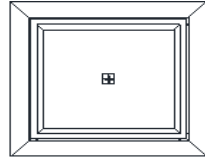
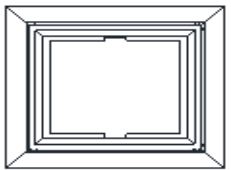

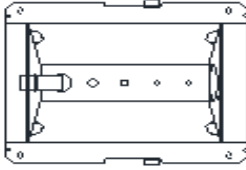



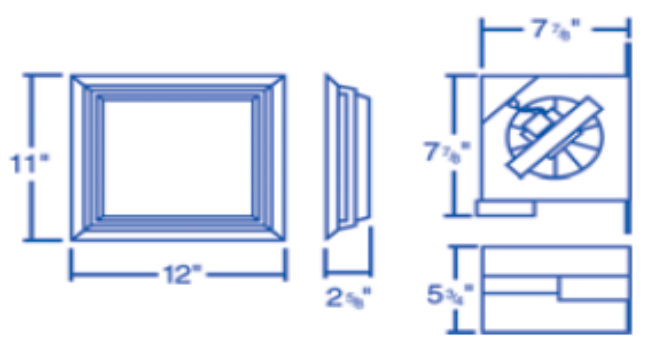
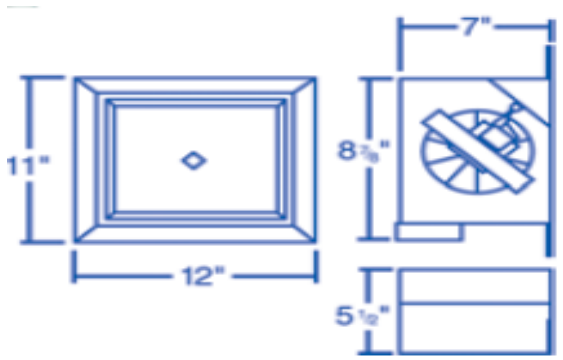





DUCTLESS BATH FANS 645 & 646



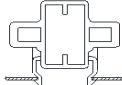
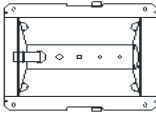

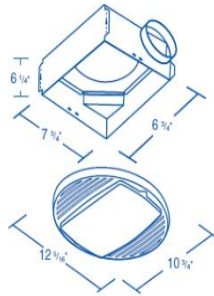

MOTOR	IMPELLER	GRILLE	
			
GM50 645 646	8710-8016 645 646	991-337-W 645	357-089-W 646
LAMP HOLDER	REFLECTOR ASY	LENS	FILTER
			PICTURE NOT AVAILABLE
398-051 646	8826-8039 646	460-010-W 646	8663-8052 645 646



ECONOMY BATH FAN/LIGHT MM6641C, MM6671C & MM6671CF

MOTOR		IMPELLER	GRILLE	LENS	DUCT ADAPTER
					
GM50 MM6641C	GM70 MM6671C MM6671CF	8710-8016 MM6641C MM6671C MM6671CF	357-106-W MM6641C MM6671C MM6671CF	3508-2002-000 MM6641C MM6671C MM6671CF	991-615 MM6641C MM6671C MM6671CF
LAMP HOLDER		REFLECTOR ASY		BALLAST ASY	NOTES
					GM50 & GM70 MOTOR/BLOWER ASSY INCLUDES IMPELLER AND MOTOR BRACKET
398-051 MM6641C MM6671C	8695-8097 MM6671CF	991-600 MM6641C MM6671C	630-067 MM6671CF	1228-2002-000 MM6671CF	
					

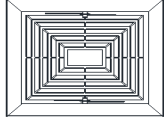
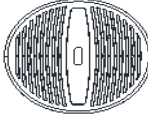
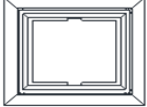
ECONOMY QUICK MOUNT SERIES A647, A664IC, MM647, MM648, AND MM748

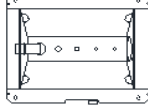
MOTOR		IMPELLER	DUCT ADAPTER		LAMP HOLDER
					
GM50 A647 A647A A647B A664IC MM647 MM647B MM648	GM70 MM748 MM748H	8710-8016 A647 A647A A647B A664IC MM647 MM647B MM648 MM748 MM748H	991-630 A647 A647A A647B MM647 MM647B MM648	991-615 A664IC MM748 MM748H	398-051 A664IC
GRILLE		LENS	GRILLE SPRING (2 REQ)	REFLECTOR ASY	
					
991-616-W A647 A647A A647B	2501-2053-000 MM647 MM647B MM648 MM748 MM748H	357-116-W A664IC	460-010-W A664IC	733-218 A647 A647A A647B MM647 MM647B MM648 MM748 MM748H	8826-8039 A664IC





NOTE: GM50 & GM70 INCLUDE MOTOR/IMPELLER AND BRACKET

FIRE RATED VENTILATORS

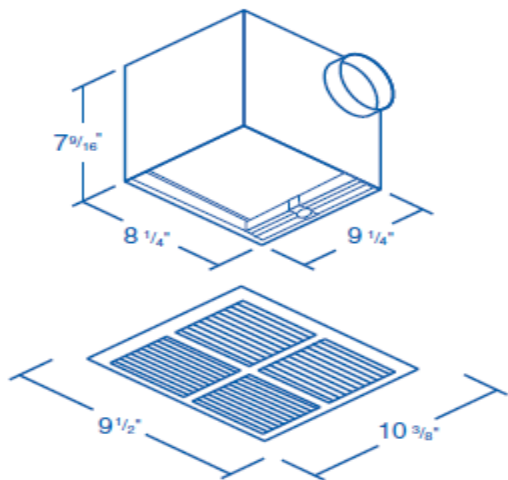



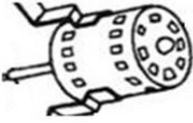
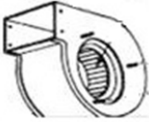
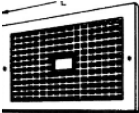





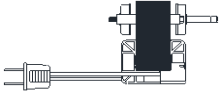
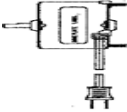

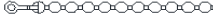
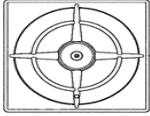
MOTOR/BLOWER ASY			LIMIT	GRILLE
PICTURE NOT AVAILABLE			PICTURE NOT AVAILABLE	PICTURE NOT AVAILABLE
Z650FRD 650FRD	Z680FRD 680FRD	Z610FRD 610FRD	FL165 650FRD 680FRD 610FRD	2501-2064-000 650FRD 680FRD 610FRD

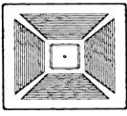

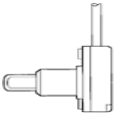
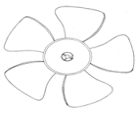
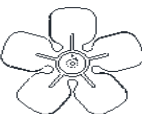
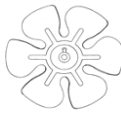



SUPER Q VENTILATORS

MOTOR		IMPELLER		
				
56343-0 CV6	56346-0 CV10	56334-0 CV6	56335-0 CV8 CV81 CV101 CV12	56367-0 CV10
56344-0 CV8	56347-0 CV101			
56345-0 CV81	56350-0 CV12			
GRILLE				GRILLE SPRING (2 REQ)
				<p style="font-size: 1.2em; margin: 0;">PICTURE NOT AVAILABLE</p>
55130-1 CV6	55131-1 CV8 CV81	55132-1 CV10	55133-1 CV101 CV12	56327-0 CV6 CV8 CV81 CV10 CV101 CV12
				



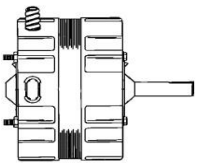
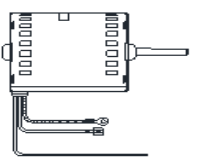
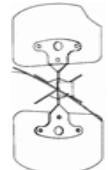
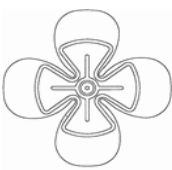
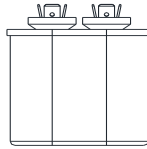
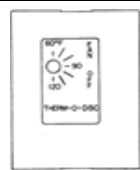
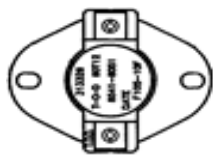





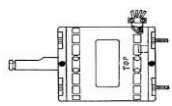
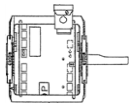
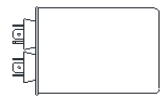
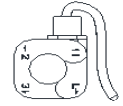

GENERAL HOME / KITCHEN FANS

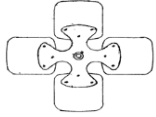
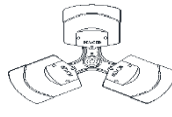
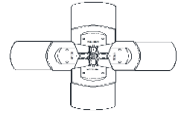
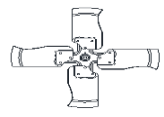
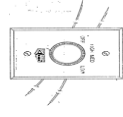
MOTOR		GRILLE KNOB		CHAIN	
					
8767-8232 898L 899L	8767-8233 790L 760L	7163-9672 1047 1080	6412-8023 790L	0899-0008 898L 899L 1047 760L 1080	
GRILLE				CONTROL KNOB	SWITCH
					
8683-8323 1047 8683-8308 1080	8683-8062 790L*	8683-8295 790L** 898L 760L	8683-8320 899L	3301-2039-000 790L	0810-0288 899L 1047
FAN				NOTES	
			* FRONT GRILLE 790L ** REAR GRILLE 790L		
8528-8026 898L 899L	8528-8152 1047 1080	8528-8075 790L			
					
790L	898L	899L			
					
1047	760L	1080			

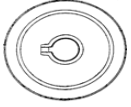
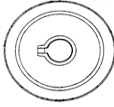



ATTIC VENTILATORS







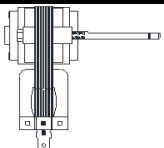

MOTOR		FAN BLADE	
			
8767-8241 RV16 GV16	7163-9739 ASRV14 AGV14	8528-8041 RV16	8528-8142 ASRV14 AGV14
		8528-8118 GV16	
CAPACITOR	THERMOSTAT		
			
6100-8036 RV16 GV16	1230-8192 RV16 GV16	8541-8051 ASRV14 AGV14	
			
RV16	ASRV14	AGV14 & GV16	

WHOLE HOUSE FANS

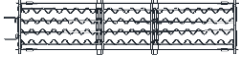
MOTOR		CAPACITOR		SWITCH	SHUTTER
					
7126-3441 A20DD	7126-3436 2438	1432-0002-001 A20DD	6100-8039 A24DD	5216-2059-000 A20DD	8862-8039 A20DD
7126-3438 A24DD	7126-3439 3038R 7126-3440 3638R	1432-0002-004 2438 3038R	6100-8026 3638R		
FAN BLADE				CONTROL ASY	SHAFT
					
8528-8069 A20DD	8528-8150 A24DD 8528-8147 2438	8528-8148 3038R	8528-8149 3638R	8587-8129 A24DD 2438 3038R 8587-8133 3638R	8856-8014 2438 3038R 3638R
MOTOR SHEAVE	FAN SHEAVE		V-BELT	 2438, 3038R & 3638R	
			PICTURE NOT AVAILABLE		
8944-8024 2438 8944-8023 3038R 8944-8022 3638R	8944-8025 2438	8944-8026 3038R 8944-8027 3638R	9707-8053 2438 9707-8054 3038R 9707-8055 3638R		
 		 			
A20DD		A24DD			



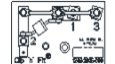

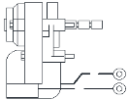
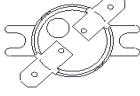

AFA SERIES (OBS)

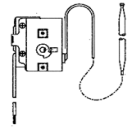
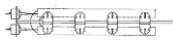
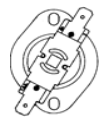
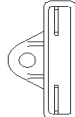
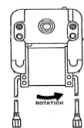

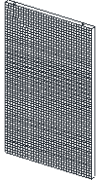
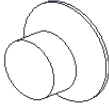
ELEMENTS					LIMIT		
							
1802-2021-000		1802-2021-003	1802-2021-004		4520-2023-000		
A1000IF	A1500IF	A1504IF	A1004IF	A2004T2B	A1000IF	A1500IFBNW	A2004IFB
A1000IFA	A1500IFA	A1504IFA	A1004IFA	A2004T2BNW	A1000IFB	A1500T	A2004IFBNW
A1000IFB	A1500IFB	A1504IFB	A1004IFB	A2404IF	A1000IFBNW	A1500T2B	A2004T
A1000IFBNW	A1500IFBNW	A1504IFBNW	A1004IFBNW	A2404IFA	A1000T	A1500T2BNW	A2004T2B
A1000T	A1500T	A1504T	A2004IF	A2404IFB	A1000T2B	A1504IF	A2004T2BNW
A1000TA	A1500TA	A1504TA	A2004IFA	A2404IFBNW	A1000T2BNW	A1504IFB	A2404IF
A1000T2	A1500T2	A1504T2	A2004IFB	A2404T	A1004IF	A1504IFBNW	A2404IFB
A1000T2B	A1500T2B	A1504T2B	A2004IFBNW	A2404TA	A1004IFB	A1504T	A2404IFBNW
A1000T2BNW	A1500T2BNW	A1504T2BNW	A2004T	A2404T2	A1004IFBNW	A1504T2B	A2404T
			A2004TA	A2404T2B	A1500IF	A1504T2BNW	A2404T2B
			A2004T2	A2404T2BNW	A1500IFB	A2004IF	A2404T2BNW
MOTOR					THERMOSTAT		
							
3900-2017-000		3900-2017-001			5813-2001-000	5813-2015-000	
A0500IFA	A1000T2	A0504IFA	A1504IF	A2004TA	A0504TA	A0504T2	A1500T2BNW
A0500IFB	A1000T2B	A0504IFB	A1504IFA	A2004T2	A1000T	A0504T2B	A1504T2B
A0500IFBNW	A1000T2BNW	A0504IFBNW	A1504IFB	A2004T2B	A1000TA	A0504T2BNW	A1504T2BNW
A0750IFA	A1500IF	A0504TA	A1504IFBNW	A2004T2BNW	A1500T	A1000T2	A2004T2
A0750IFB	A1500IFA	A0504T2	A1504T	A2404IF	A1500TA	A1000T2B	A2004T2B
A0750IFBNW	A1500IFB	A0504T2B	A1504TA	A2404IFA	A1504T	A1000T2BNW	A2004T2BNW
A1000IF	A1500IFBNW	A0504T2BNW	A1504T2	A2404IFB	A1504TA	A1500T2	A2404T2B
A1000IFA	A1500T	A0754IFA	A1504T2B	A2404IFBNW	A1504T2	A1500T2B	A2404T2BNW
A1000IFB	A1500TA	A0754IFB	A1504T2BNW	A2404T	A2004T		
A1000IFBNW	A1500T2	A0754IFBNW	A2004IF	A2404TA	A2004TA		
A1000T	A1500T2B	A1004IF	A2004IFA	A2404T2	A2404T		
A1000TA	A1500T2BNW	A1004IFA	A2004IFB	A2404T2B	A2404TA		
		A1004IFB	A2004IFBNW	A2404T2BNW	A2404T2		
		A1004IFBNW	A2004T				

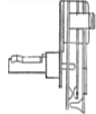
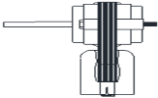





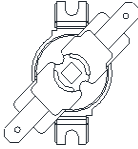
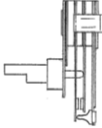
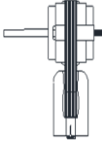



CRA SERIES									
KNOB		GRILLE	LIGHT				ELEMENT		
									
3301-2039-002		2501-2065-000	3510-2017-000	3510-2017-001	3510-2017-002	3510-2017-003	1802-2124-005	1802-2124-000	1802-2124-003
C1012T2 C1024T2 C1512T2 C1524T2 C2024T2 C2028T2 C2224T2 C1012T2A C1024T2A C1512T2A C1524T2A C2024T2A C2028T2A C2224T2A	C1012T2AA C1512T2AA C1012T2AB C1024T2AB C1512T2AB C1524T2AB C2024T2AB C2028T2AB C1524T2AB C2024T2AB C2224T2AB C1512T2B C1524T2B C2024T2B C2224T2B C1512T2C C2024T2C C2224T2C	C1512IFB C1512T2B C2024IFB C2024T2B C2028IFB C2224IFB C1512IFC C1512T2A C1512T2C C2024IFC C2224T2C C1512IFA C1012T2A C1512IFA C2024T2C C2028IFC C2224IFC C2224T2C	C1012IF C1012T2 C1512IF C1512T2 C1012IFA C1012T2A C1512IFA C1012FAA C1012T2AA C1512FAA C1512T2AA C1012IFAB C1024T2AB C1524IFAB C2024T2AB C2028IFC C1524T2AB C2024IFB C2024T2B C2024IFC C2024T2C	C1024IF C1024T2 C1524IF C1524T2 C2024IF C2024T2 C2028IF C2028T2 C2224IF C2224T2 C1024IFA C1024T2A C1524IFA C1524T2A C2024IFA C2024T2A C2028IFA C2028T2A C2224IFA C2224T2A	C1512IFAB C1512T2AB C1512IFB C1512T2B C1512IFC C1512T2C	C1024IFAB C1024T2AB C1524IFAB C1524T2AB C2024IFAB C2024T2AB C2028IFAB C2028T2AB C2224IFAB C2224T2AB C2024IFB C2024T2B C2028IFB C2028T2AB C2224IFB C2224T2AB C2024IFC C2024T2C C2028IFC C2028T2AB C2224IFC C2224T2C	C1024IF C1024T2 C2024IF C2024T2 C1024IFA C1024T2A C2024IFA C2024T2A C2028IFA C2028T2A C2224IFA C2224T2A C2024IFB C2024T2B C2028IFB C2028T2A C2224IFB C2224T2AB C2024IFC C2024T2C C2028IFC C2028T2A C2224IFC C2224T2C	C1512IF C1512T2 C1512IFA C1512T2A C1524T2A C2028IFB C2224T2AB C2024IFB C2224T2B	C1012IFA C1012T2A C1512IFA C1512T2A C2024IFA C2024T2A C2028IFA C2028T2A C2224IFA C2224T2A C2024IFB C2024T2B C2028IFB C2028T2A C2224IFB C2224T2AB C2024IFC C2024T2C C2028IFC C2028T2A C2224IFC C2224T2C
MODELS NOT LISTED ARE OBSOLETE									
FAN BLADE		MOTOR			HI LIMIT				CLIP N FIT BOARD
									
1210-2008-000 ALL MODELS	3900-2017-000	3900-2017-001	3900-2035-000	4520-11007-000	4520-11007-001	4520-2059-000			1249-2005-000
	C1012IF C1012T2 C1512IF C1512T2 C1012IFA C1012T2A C1512IFA C1512T2A C1012IFAA C1012T2AA C1512IFAA C1512T2AA C1012IFAB C1012T2AB C1512IFAB C1512T2AB C1512IFB C1512T2B C1512IFC C1512T2C	C1024IF C1024T2 C1524IF C1524T2 C2024IF C2024T2 C1024IFA C1024T2A C1524IFA C1524T2A C2024IFA C2024T2A C2028IFAB C1524T2A C2024IFA C2024T2A C1024IFAB C1024T2AB C1524IFAB C1524T2AB C2024IFAB C2024T2AB C2024IFB C2024T2B C2024IFC C2024T2C	C2028IF C2028T2 C2224IF C2224T2 C2028IFA C2028T2A C2224IFA C2224T2A C2028IFAB C2224IFAB C2224T2B C2028IFC C2224IFC C2224T2C	C1512IFC C1512T2C	C2024IFC C2024T2C C2028IFC C2224IFC C2224T2C	C1012IF C1012T2 C1512IF C1512T2 C1012IFA C1012T2A C1512IFA C1512T2A C1012IFAA C1012T2AA C1512IFAA C1512T2AA C1012IFAB C1012T2AB C1512IFAB C1512T2AB C1512IFB C1512T2B C1512IFC C1512T2C	C2024IF C2024T2 C1024IFA C1024T2A C1524IFA C1524T2A C2024IFA C2024T2A C1024IFAB C1024T2AB C1524IFAB C1524T2AB C2024IFAB C2024T2AB C2024IFB C2024T2B C2028IF C2224IF C2224T2 C1524IF C2028IFA C2028T2A	C2224IFA C2224T2A C2028IFAB C2224IFAB C2224T2B C2224T2B C2024IFB C2024T2B C2028IFB C2224IFC C2224T2C	C1512IFB C1512T2B C2024IFB C2028IFB C2224IFB C2224T2B C1512IFC C1512T2C C2024IFC C2024T2C C2224IFC C2224T2C
THERMOSTAT		THERMAL FUSE							
410130001	5813-2090-000	4520-2030-000							
C1012T2 C1512T2 C1012T2A C1512T2A C1012T2AA C1512T2AA C1024T2 C1524T2 C2024T2 C1024T2A C1524T2A C2024T2A C2028T2 C2224T2 C2028T2A C2224T2A	C1012T2AB C1512T2AB C1512T2B C1512T2C C1024T2AB C1524T2AB C2024T2AB C2024T2B C2024T2C C2224T2AB C2224T2B C2224T2C	C1012FAA C1012T2AA C1512FAA C1512T2AA C1024IFAB C1024T2AB C1524IFAB C1524T2AB C2024IFAB C2024T2AB C2024IFB C2024T2B C2024IFC C2024T2C	C1512IFB C1512T2B C1512FAA C2024IFB C1512T2AA C2024T2B C1012IFAB C1012T2AB C1512IFAB C1512T2AB C1512IFC C1512T2C C1024IFAB C1512T2C C1512T2C C2024IFC C2024T2C C2028IFC C2224IFC C2224T2C						

QVP					
MOTOR				LIMIT	
					
42528-052-01		42528-052-02		4520-2025-000	
VP1222	VP1222I	VP2022	VP2022I	VP1222C	VP2022IC
VP1222A	VP1222IB	VP2022A	VP2022IB	VP1222CNW	VP2022ICNW
VP1222AI	VP1222IBP	VP2022AI	VP2022IBP	VP1222IC	VP2422C
VP1222B	VP1222IC	VP2022B	VP2022IC	VP1222ICNW	VP2422CNW
VP1222C	VP1222ICNW	VP2022C	VP2022ICNW	VP2022C	VP2422IC
VP1222CNW		VP2022CNW		VP2022CNW	VP2422ICNW

A2500					
THERMOSTAT	ELEMENT	LIMIT	THERMAL FUSE	GRILLE	MOTOR
				PICTURE NOT AVAILABLE	
1230-8232	6101-8752	8541-8056	8671-8037	8683-8272	8767-8036
A2515T	A2530T	A2515T	A2515T	A2515T	A2515T
A2520T		A2520T	A2520T	A2520T	A2520T
A2530T		A2530T	A2530T	A2530T	A2530T
A2540T		A2540T	A2540T	A2540T	A2540T
A2548T		A2548T	A2548T	A2548T	A2548T

1235 & 2435 SERIES (OBS)					
SCREEN		KNOB	FACE PLATE	LIMIT	
					
1235-0037 1235 2435	8850-8046 1235P 2435P	3301-2047-000 ALL MODELS	4503-2094-000 ALL MODELS	8541-8054 ALL MODELS	
THERMOSTAT	MOTOR	FAN BLADE	ELEMENT	THERMAL FUSE	
					
1230-8194 ALL MODELS	1235-0007 ALL MODELS	1235-0008 ALL MODELS	6101-8741 ALL MODELS	8671-8036 2435 2435P	

B2400 SERIES (OBS)			
ELEMENT		LIMIT	THERMOSTAT
			
6101-8741 B2451	6101-8742 B2452	8541-8055 ALL MODELS	1230-8206 ALL MODELS
MOTOR		FAN BLADE	THERMAL FUSE
			
8767-8035 B2451	8767-8036 B2452	991-313 ALL MODELS	8671-8037 B2452

CWH2000								
ELEMENT							BLADE	
								
302023801 CWH2101 CWH2101A CWH2101B CWH2101BWW CWH2101DS CWH2101DSB CWH2101DSBWW CWH2101DF CWH2101F	302023802 CWH2151 CWH2151A CWH2151B CWH2151BWW CWH2151DS CWH2151DSB CWH2151DSBWW CWH2151F	302023803 CWH2157 CWH2157A CWH2157B CWH2157BWW CWH2157DSBWW CWH2157F	302023804 CWH2208 CWH2208A CWH2208B CWH2208BWW CWH2208SBNW CWH2208F	302023805 CWH2202 CWH2202A CWH2202B CWH2202BWW CWH2202DS CWH2202DSB CWH2202DSBWW CWH2202F	302023806 CWH2207 CWH2207A CWH2207B CWH2207BWW CWH2207DS CWH2207DSB CWH2207DSBWW CWH2207F	302023808 CWH2201 CWH2201A CWH2201B CWH2201BLT CWH2201BWW CWH2201DS CWH2201DSB CWH2201DSBWW CWH2201F	490061001 ALL MODELS	
MOTOR				THERMOSTAT				KNOB
								
490062001 CWH2101 CWH2101A CWH2101B CWH2101BWW CWH2101DS CWH2101DSB CWH2101DSBWW CWH2101F CWH2151 CWH2151A CWH2151B CWH2151BWW CWH2151DS	CWH2151DSB CWH2151DSBWW CWH2151F CWH2201 CWH2201A CWH2201B CWH2201BLT CWH2201BWW CWH2201DS CWH2201DSB CWH2201DSBWW CWH2201F	490062002 CWH2208 CWH2208A CWH2208B CWH2208BWW CWH2208SBNW CWH2208F	490062003 CWH2202 CWH2202A CWH2202B CWH2202BWW CWH2202DS CWH2202DSB CWH2202DSBWW CWH2202F	490062004 CWH22157 CWH22157A CWH22157B CWH22157BWW CWH22157F CWH2207 CWH2207A CWH2207B CWH2207BWW CWH2207DS CWH2207DSB CWH2207DSBWW CWH2207F	5813-2001-000 CWH2101 CWH2101A CWH2101B CWH2101BWW CWH2101DS CWH2101DSB CWH2101DSBWW CWH2101F CWH2151 CWH2151A CWH2151B CWH2151BWW CWH2151DS CWH2151DSB CWH2151DSBWW CWH2151F CWH2157 CWH2157A CWH2157B CWH2157BWW CWH2157DSB CWH2157DSBWW CWH2157F	5813-2022-000 CWH2201 CWH2201A CWH2201B CWH2201BWW CWH2201DS CWH2201DSB CWH2201DSBWW CWH2201F	3301-2001-000 MODELS W/THERMOSTAT	
FAN DELAY		LIMIT		MANUAL RESET	LIGHT		DISCONNECT SW	
								
410074000 CWH2101 CWH2101B CWH2101BWW CWH2101DS CWH2101DSB CWH2101DSBWW CWH2101F CWH2151 CWH2151B CWH2151BWW CWH2151DS CWH2151DSB CWH2151DSBWW CWH2151F CWH2157 CWH2157B CWH2157BWW CWH2157DSBWW CWH2157F CWH2201 CWH2201B CWH2201BLT CWH2201BWW	CWH2201DSB CWH2201DSBWW CWH2201F CWH2202 CWH2202B CWH2202BWW CWH2202DS CWH2202DSB CWH2202DSBWW CWH2202F CWH2207 CWH2207B CWH2207BWW CWH2207DS CWH2207DSB CWH2207DSBWW CWH2208 CWH2208B CWH2208BWW CWH2208SBNW CWH2208F	1414-2009-000 CWH2101A CWH2101DS CWH2151A CWH2151DS CWH2157A CWH2201A CWH2201DS CWH2202A CWH2202DS CWH2202DSB CWH2202F CWH2207A CWH2207DS CWH2208A	410143000 CWH2101 CWH2101B CWH2101BWW CWH2101DS CWH2101DSB CWH2101DSBWW CWH2101F CWH2151 CWH2151B CWH2151BWW CWH2151DS CWH2151DSB CWH2151DSBWW CWH2151F CWH2157 CWH2157B CWH2157BWW CWH2157DSBWW CWH2201F CWH2208 CWH2208B CWH2208BWW CWH2208SBNW CWH2208F	4520-11016-000 CWH2101A CWH2101DS CWH2151A CWH2157A CWH2201A CWH2201DS CWH2202A CWH2202DS CWH2202DSB CWH2202F CWH2207A CWH2207DS CWH2208A	3510-2008-002 CWH2157B CWH22157BWW CWH22157DSBWW CWH2202B CWH2202BWW CWH2202DS CWH2202DSB CWH2202DSBWW CWH2207B CWH2207BWW CWH2207DS CWH2207DSB CWH2207DSBWW CWH2208B CWH2208BWW CWH2208SBNW	3510-2008-003 CWH2101B CWH2101BWW CWH2101DS CWH2101DSB CWH2151B CWH2151BWW CWH2151DS CWH2151DSB CWH2151DSBWW CWH2201B CWH2201BLT CWH2201BWW CWH2201DS CWH2201DSB CWH2201DSBWW	410170001 CWH2101DS CWH2101DSB CWH2101DSBWW CWH2151DS CWH2151DSB CWH2151DSBWW CWH2201DS CWH2201DSB CWH2201DSBWW CWH2202DS CWH2202DSB CWH2202DSBWW CWH2207DS CWH2207DSB CWH2207DSBWW CWH2208DSBWW	

CU-A & CU-B OBSOLETE							
MODEL CU-B							
CABINET SERIES	PART NUMBER						
	FINTUBE HEATING ELEMENT (RETANGULAR ALUMINUM FIN)					FILTERS A & B MODELS	
	QTY.	208V	240V	277V & 480V 4-WIRE	480V 3-WIRE	THROWAWAY	REUSABLE
1200	2						
1300	3						
1400	4	1802-0103-001	1802-0103-002	1802-0103-003	1802-0103-004	2010-7008-001	2010-7009-001
1500	5						
1600	6						
2200	2						
2300	3						
2400	4	1802-0103-005	1802-0103-006	1802-0103-007	1802-0103-008	2010-7008-002	2010-7009-002
2500	5						
2600	6						
3200	2						
3300	3						
3400	4	1802-0103-009	-	1802-0103-011	1802-0103-012	2010-7008-003	2010-7009-003
3500	5						
3600	6						
4200	2						
4300	3						
4400	4	-	1802-0103-014	-	1802-0103-016	2010-7008-004	2010-7009-004
4500	5						
4600	6						
5200	2						
5300	3						
5400	4	-	-	-	-	2010-7008-005	2010-7009-005
5500	5						
5600	6						

MODELS CU-A & CU-B							
CABINET SERIES	PART NUMBER						
	BLOWER WHEEL	SHAFT	BEARINGS (2 EA)	COUPLING	FAN MOTOR	HIGH LIMIT	
						ALL EXCEPT CUI	CUI MODELS ONLY
1200-1600	6406-7001-001	-	-	-	3900-0558-000	4520-0011-007	-
2200-2600	6406-7001-001	-	-	-	3900-0559-000	4520-0011-007	-
3200-3600	6406-7001-002	5217-7007-001	2011-7017-000	1410-7003-001	3900-0563-000	-	4520-0011-009
4200-4600	6406-7001-002	5217-7007-002	2011-7017-000	1410-7003-001	3900-0563-000	-	4520-0011-009
5200-5600	6406-7001-002	5217-7007-003	2011-7017-000	1410-7003-001	3900-0563-000	-	4520-0011-009

PARTS COMMON TO ALL MODELS				CIRCUIT BREAKERS						
DESCRIPTION	PART NUMBER	VOLTAGE RATING	NUMBER OF POLES	AMPS	PART NUMBERS					
FAN RELAY:		240V	2	15	4520-7009-014					
24V	CUBFDRK24				4520-7009-015					
120V	CUBFDRK120				4520-7009-016					
240V	CUBFDRK240				4520-7009-017					
SELECTOR SWITCH	5216-0302-000				4520-7009-018					
THERMOSTAT	-				4520-7009-019					
STEP-DOWN TRANSFORMER	5814-7013-003				4520-7009-020					
BUCK-BOOST TRANSFORMER	490015007				4520-7009-021					
SUMMER FAN SWITCH	5216-0302-000				4520-7009-022					
*CONTACTORS, CU-B					480V	2	15	4520-7009-008		
2 POLE/30 AMP, 24V HOLDING COIL	5018-0003-000	4520-7009-004								
2 POLE/30 AMP, 120V HOLDING COIL	5018-0003-001	4520-7009-010								
2 POLE/30 AMP, 208V/240V HOLDING COIL	5018-0003-002	4520-7009-005								
3 POLE/ 35 AMP, 24V HOLDING COIL	5018-0005-004	4520-7009-011								
3 POLE/ 35 AMP, 120V HOLDING COIL	5018-0005-005	4520-7009-006								
3 POLE/ 35 AMP, 208V/240V HOLDING COIL	5018-0005-006	4520-7009-012								
*CONTACTORS, CU-A		480V	2	15				4520-7009-001		
2 POLE/30 AMP, 24V HOLDING COIL	5018-0004-100							4520-7009-007		
2 POLE/30 AMP, 120V HOLDING COIL	5018-0004-101							4520-7008-013		
2 POLE/30 AMP, 208V/240V HOLDING COIL	5018-0004-102				4520-7008-014					
3 POLE/ 50 AMP, 24V HOLDING COIL	5018-0006-000				4520-7008-015					
3 POLE/ 50 AMP, 120V HOLDING COIL	5018-0006-001				4520-7008-016					
3 POLE/ 50 AMP, 208V/240V HOLDING COIL	5018-0006-002				4520-7008-017					
* SEE INSTALLATION INSTRUCTIONS FOR SELECTION CHART OR CONSULT FACTORY					480V	3	15	4520-7008-018		
								4520-7008-020		
								4520-7008-021		
		4520-7008-022								
		4520-7008-005								
		4520-7008-006								
		4520-7008-008								
		4520-7008-001								
		4520-7008-009								
		4520-7008-007								

Reference Data

HOW TO ORDER

RATING SERIES PRODUCT NUMBERS

The last group of four numbers describe the Unit Size, Heating Capacity Voltage Rating and Type of Control:

Number of Fans and Cabinet Series are indicated by the first number.

- 1 - One Fan Series 1000 Cabinet
- 2 - Two Fans Series 2000 Cabinet
- 3 - Three Fans Series 3000 Cabinet
- 4 - Four Fans Series 4000 Cabinet
- 5 - Five Fans Series 5000 Cabinet

Number of Fintube Heating Elements and the corresponding Unit Heating Capacity are indicated by the second number.

	Cabinet Series				
	1000	2000	3000	4000	5000
2 Element	2.0kW	4.0kW	5.3kW	6.7kW	8.0kW
3 Element	3.0kW	6.0kW	8.0kW	10.0kW	12.0kW
4 Element	4.0kW	8.0kW	10.7kW	13.3kW	16.0kW
5 Element	5.0kW	10.0kW	13.3kW	16.7kW	20.0kW*
6 Element	6.0kW	12.0kW	16.0kW	20.0kW	24.0kW*

Not available in all voltages. See table on page 2.

Electric Power Supply for the heating Circuit is indicated by the third number as follows:

- 1 - 208V Single Phase 4 - 240V Three Phase 7 - 480V Three Phase 3 Wire
- 2 - 208V Three Phase 5 - 277V Single Phase 8 - 347V Single Phase
- 3 - 240V Single Phase 6 - 480V Three Phase 4 Wire 9 - 600V Three Phase

Control Supply and Circuit are defined by the fourth number.

NOTE: A thermostat either integral or remote, must be used for proper operation of heater.

	Thermostat	Voltage	Supply	For Use Only With Models
0-	Integral	120	External	CUC, CUF, CUW
1-	Integral	24	External	CUC, CUF, CUW
2-	Integral	208/240*	Internal	CUC, CUF, CUW
3-	Remote	120	External	All Models
4-	Remote	24	External	All Models
5-	Remote	208/240*	Internal	All Models
6-	Remote	24	Internal	All Models
7-	Remote	120	Internal	All Models
8-	Integral	24	Internal	CUC, CUF, CUW
9-	Integral	120	Internal	CUC, CUF, CUW

*Control Voltage is 208 VAC on units with 208 VAC Heating Circuit.





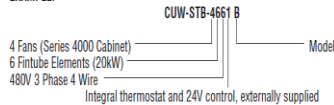

MODEL LETTER

The letter "B" at the end of the catalog number designates the unit as a "B" model.

EXAMPLE:

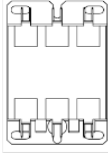
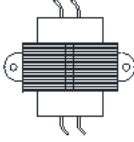

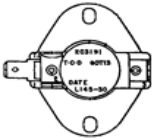
VUH & VUH-A

BLADE	RELAY		TRANSFORMER	
				
490020000 H2520 H2524 H2548 H2555 H2560 H3020 H3024 H3048 H3055 H3060 H4020 H4024 H4048 H4055 H4060	5018-0005-006 H1020A H1024A H1027A H1034A H1048A H1055A H1060A H1520A H1524A H1527A H1534A	5018-0006-002 H1048A H1555A H1560A H2020 H2024 H2027 H2034 H2048 H2055 H2060	490015018 H1034A H1534A	490015008 H5048 H5055
			490015019 H2034	490015012 H2060 H2560 H3060 H4060
			490015021 H1060A H1560A	
			490015005 H2027	490015015 H5060
LIMIT	FAN DELAY	CAPACITOR		
				
410029000 ALL MODELS	410126000 ALL MODELS	1432-0002-003 ALL MODELS		

KD/KS			
UNIT SIZE	PART NUMBER		
	208V	240V	277V
ELEMENTS (AFTER 1993) (250 WATTS/FT. - SEE NOTE 1)			
24" CABINET	1802-2016-001	1802-2016-003	1802-2016-003
36" CABINET	1802-2016-009	1802-2016-010	1802-2016-011
48" CABINET	-	1802-2016-024	1802-2016-024
REPAIR PARTS (AFTER 1993)			
DISCRIPTION		PART NUMBER	
SPOT HIGH LIMIT		410027000	
OPT. THERMOSTAT, 1-POLE		410112000	
OPT. THERMOSTAT, 2-POLE		410113000	
OPTIONAL RELAY (PRIOR TO 1993) (SEE NOTE 2)			
IDENTIFICATION NUMBER ON RELAY		PART NUMBER	
134-60103-301 (24V)		5018-2006-000	
134-60203-301 (120V)		5018-2021-001	
134-60303-301 (208V/240V)		5018-2006-002	
134-62303-301 (277V)		5018-2006-003	
NOTE 1: 500W/FT. UNITS REQUIRE 2 ELEMENTS. 750W/FT. UNITS REQUIRE 3 ELEMENTS. 1000W/FT. UNITS REQUIRE 4 ELEMENTS.			
NOTE 2: WITH SUFFIX "R" ADDED TO CATALOG NUMBER.			

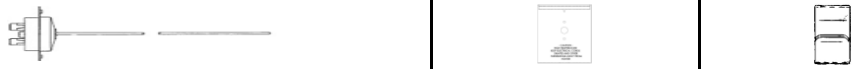
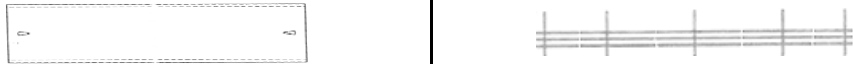
QDB SERIES				
				
DISCRIPTION	PART NUMBERS			
	120V	208V	240V	277V
*ELEMENT (100 WATTS/FT)				
38"	1802-2016-014	1802-2016-006	1802-2016-007	1802-2016-015
50"	1802-2016-016	1802-2016-017	1802-2016-018	1802-2016-019
62"	1802-2016-026	1802-2016-027	1802-2016-028	1802-2016-029
*ELEMENT (188 WATTS/FT)				
38"	1802-2016-012	1802-2016-010	1802-2016-011	1802-2016-013
50"	1802-2016-020	1802-2016-024	1802-2016-025	1802-2016-021
62"	1802-2016-030	1802-2016-034	1802-2016-035	1802-2016-031
				
LINEAR LIMIT		TERMINAL BOX COVER	ELEMENT HANGER CLIP	
38"	410122003	310527001	402020000	
50"	410122004			
62"	410122005			
				
FRONT COVER		TOP GRILLE ASSEMBLY		
38"	310124008	38"	310817903	
50"	310124009	50"	310817904	
62"	310124010	62"	310817905	



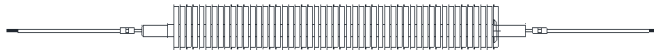





ADB, APH, & ASH SERIES



DISCRPTION	PART NUMBERS					
	120V	208V	240V	277V	347V	600V
*ELEMENT (125 WATTS/FT)						
28" HEATER	1802-2001-085	1802-2001-086	1802-2001-048	1802-2001-049	NA	NA
3'	1802-2001-087	1802-2001-088	1802-2001-054	1802-2001-055	1802-2001-220	NA
4'	1802-2001-089	1802-2001-090	1802-2001-060	1802-2001-061	1802-2001-230	NA
5'	1802-2001-091	1802-2001-092	1802-2001-066	1802-2001-067	1802-2001-240	1802-2001-241
6'	1802-2001-093	1802-2001-094	1802-2001-072	1802-2001-073	1802-2001-250	1802-2001-251
8'	NA	1802-2001-095	1802-2001-077	1802-2001-078	1802-2001-260	1802-2001-261
10'	NA	1802-2001-096	1802-2001-081	1802-2001-082	1802-2001-270	1802-2001-271
*ELEMENT (188 WATTS/FT)						
28" HEATER	1802-2001-005	1802-2001-002	1802-2001-001	1802-2001-000	NA	NA
3'	1802-2001-011	1802-2001-008	1802-2001-007	1802-2001-006	1802-2001-216	NA
4'	1802-2001-017	1802-2001-014	1802-2001-013	1802-2001-012	1802-2001-226	1802-2001-227
5'	1802-2001-023	1802-2001-020	1802-2001-019	1802-2001-018	1802-2001-236	1802-2001-237
6'	1802-2001-029	1802-2001-026	1802-2001-025	1802-2001-024	1802-2001-246	1802-2001-247
8'	NA	1802-2001-032	1802-2001-031	1802-2001-030	1802-2001-256	1802-2001-257
10'	NA	1802-2001-036	1802-2001-035	1802-2001-034	1802-2001-266	1802-2001-267
*ELEMENT (250 WATTS/FT)						
28" HEATER	1802-2001-004	1802-2001-003	1802-2001-002	1802-2001-001	1802-2001-202	NA
3'	1802-2001-010	1802-2001-009	1802-2001-008	1802-2001-007	1802-2001-214	NA
4'	1802-2001-016	1802-2001-015	1802-2001-014	1802-2001-013	1802-2001-013	1802-2001-225
5'	1802-2001-022	1802-2001-021	1802-2001-020	1802-2001-019	1802-2001-234	1802-2001-235
6'	1802-2001-028	1802-2001-027	1802-2001-026	1802-2001-025	1802-2001-244	1802-2001-245
8'	NA	1802-2001-033	1802-2001-032	1802-2001-031	1802-2001-254	1802-2001-255
10'	NA	1802-2001-037	1802-2001-036	1802-2001-035	1802-2001-264	1802-2001-265

* 1, 2 OR 3 ELEMENTS MAY BE REQUIRED. VOLTAGE AND WATTAGE ARE STAMPED ON END OF ELEMENTS. DIVIDE THE WATTAGE BY THE HEATER LENGTH (FEET) TO DETERMINE WATTS/FOOT OF ELEMENT. THEN USE THIS DATA TO DETERMINE PART NUMBER OF HEATING ELEMENT.



DISCRPTION	PART NUMBERS					
	120V	208V	240V	277V	347V	600V
LINEAR LIMIT						
28" HEATER	4520-0007-007	4520-0007-007	4520-0007-007	4520-0007-007	4520-0007-007	4520-0007-007
3'	4520-0007-008	4520-0007-008	4520-0007-008	4520-0007-008	4520-0007-008	4520-0007-008
4'	4520-0007-009	4520-0007-009	4520-0007-009	4520-0007-009	4520-0007-009	4520-0007-009
5'	4520-0007-010	4520-0007-010	4520-0007-010	4520-0007-010	4520-0007-010	4520-0007-010
6'	4520-0007-011	4520-0007-011	4520-0007-011	4520-0007-011	4520-0007-011	4520-0007-011
8'	NA	4520-0007-012	4520-0007-012	4520-0007-012	4520-0007-012	4520-0007-012
10'	NA	4520-0007-013	4520-0007-013	4520-0007-013	4520-0007-013	4520-0007-013
DISCONNECT SW.	THERMOSTAT	TRANSFORMER RELAY		24V TRANSFORMER	PNEUMATIC CONTROL	
						
410170001	2-STAGE 5813-0023-000 SINGLE POLE 5813-0024-000	120V 5018-11003-000 208/240V 5018-11003-001	277V 5018-11003-002 347V 5018-11003-003	208/240V PRIMARY 490026001 277V PRIMARY 490026002	ALL MODELS 5216-7027-005	
CIRCUIT BREAKER	POWER RELAY					
						
2-POLE, 30A 1226-7009-013 2-POLE, 60A 1226-7009-010 3-POLE, 30A 1226-7009-005 3-POLE, 60A 1226-7009-002	24V 5018-2017-001 120V 5018-2021-001 208/240V 5018-2021-002	277V 410171003				



RDO SERIES				
KEY NUMBER	DESCRIPTION	PART NUMBER		
		RDO26	RDO35	RDO48
1	REFLECTOR: 60/90 SYM	-	-	-
	30 DEGREES SYM	-	-	-
	60/90 ASYM	-	-	-
	30 DEGREES ASYM	-	-	-
2	INSULATOR	-	-	-
3	TERMINAL BLOCK (4 REQ)	1224-0049-000	1224-0049-000	1224-0049-000
4	ELEMENT TERM. BUSH. (4 REQ)	1213-0070-000	1213-0070-000	1213-0070-000
SOME ELEMENTS AVAILABLE-SEE FACTORY				
QRH SERIES				
ELEMENTS	RH16-91S-208	2QL16208		
	RH16-91S-240	2QL16240		
	RH16-91S-277	2QL16277		

OBSELETE INDUSTRIAL AIR CIRCULATORS			
BLADE			SWITCH
LCCLIN2419BL LCHHD24	1210-2035-000 LCHXN24	1210-2014-000 LCHIN24	5216-2059-000 LCHHD24
LCCLIN30BL LCHHD30	LCCLIN3016BL LCHXN30	1210-2026-000 LCHIN30	LCHHD30 LCHIN24 LCHIN30